

# Tools Catalogue 2015/2016

Let's connect.

Connectivity and electrical installation



**Weidmüller** 



## Dear Customers,

The PDF versions of our catalogues offer practical additional functions, helping you to find your way around our product range and simplifying the ordering process.

In addition to the catalogue, the PDF also contains:

- Internal page links
- Links to the online catalogue

Try it out for yourself. Click the order number to obtain more detailed information and close-up images via you web browser. The links in the PDF file also enable you to go directly to the next desired catalogue page.

Further Weidmüller product catalogues can be accessed by clicking the following:







# Tools

## Catalogue 6

### Tools

Certification

Cutting

Stripping

Crimping

Pliers

Screw drivers

Measuring / Testing

Tool sets

Automatic machines

Accessories

Cable lugs and insulated connectors

### Appendix

### Index

Search according to type or order number,  
worldwide activities

# Tools

**Cutter KT**  
Page B.4



**Front cable cutter**  
Page B.6



**Cable cutter KT**  
Page B.7



**Stripping and cutting tools**  
Page C.4



**Sheathing strippers**  
Page C.12



**Stripping tool for coax cable**  
Page C.14



**Crimping and cutting tool**  
Page D.6



**Crimping tools for wire end ferrules**  
Page D.8



**Crimping tools for other contacts**  
Page D.16



**Pressing tools**  
Page D.28



**Crimping tools for connectors**  
Page D.31



**Pliers**  
Page E.3



**Torque screwdrivers**  
Page F.6



**DMS manual**  
Page F.10



**Cable gland tools**  
Page F.16



**Screwdrivers**  
Page F.17



**Digital voltage tester**  
Page G.6



**2-pole voltage tester**  
Page G.8



**Digital multimeter + others**  
Page G.15



**Tool cases**  
Page H.4



**Crimp Sets**  
Page H.6



**Automatic machines**  
Page I.5



**Accessories**  
Page J.3



**Kabelschuhe und isolierte Verbinder**  
Seite K.9



# Professional tools for installation work

## Specialised and practical

Weidmüller has been developing and manufacturing quality tools for the many diverse, extensive and highly demanding uses in industry for over 30 years. Our single goal when developing new solutions is simply to make your work easier, to facilitate efficient work process and to help facilitate increased productivity now and and long-term.

### Cutting tool

The KT 45 R has a lot going for it: an extremely narrow grip width, energy-efficient operation, cuts up to 400 mm<sup>2</sup> and an easy release option even under load.

### Stripping tool

You can achieve precise stripping results ranging from 0.08 to 10 mm<sup>2</sup> with the stripax<sup>®</sup> self-adjusting stripping tool. The perfect addition: stripax<sup>®</sup> 16, 6 to 16 mm<sup>2</sup>, with a blade shape developed specifically for the task in hand.



### Sheath stripper

The AM 16 sheathing stripper allows you to remove a section of sheathing in the middle of a cable, in order to generate equipotential bonding for achieving electromagnetic compatibility with a clamping yoke.



**Crimping tool**

The rotating die of the PZ 6 roto means that wire end ferrules can be inserted from the front or the side. Highest processing quality is guaranteed with a single die of 0.14 to 6 mm<sup>2</sup>.



**Cutting tool**

The specially designed cutters on our KT tools result in smooth and straight cuts every time, without deforming the conductor.



**Torque screwdriver**

With this tool, you will always be within the correct torque range. It guarantees safe and gas-tight connections, prevents the screw clamps from being mechanically damaged, and results in a voltage drop well below the stipulated limits.





# Certification

---

<b>Certification</b>	Tool Certification to DIN ISO 9001	A.2
	Manufacturing expertise	A.5

---



## Introduction

A

Precision tools by Weidmüller are in use all over the world. This is a responsibility Weidmüller takes seriously, offering comprehensive services to support this global use.

Tools in daily use should always guarantee consistent processing quality even after many working cycles. This is why Weidmüller offers its customers the "Tool Certification" service. This technical testing procedure is Weidmüller's warranty for the functionality and quality of its tools.

The following pages provide a summary of our current range of services.





Regular quality checks of Weidmüller processing tools and the assemblies made with them guarantee optimum safety. In order to keep it that way and to prevent possible machine stoppages during production, regular maintenance and precise tool calibration is simply indispensable.

In order to receive a certified tool, customers have the option of either returning an existing Weidmüller tool for re-certification, or of purchasing a certified Weidmüller tool on submitting a new order.

Certification includes:

- Conductor extraction force testing according to relevant DIN regulations
- Issue of a test certificate with corresponding identification number and allocated customer number
- Recommendation for the next certification date; special testing intervals available on request

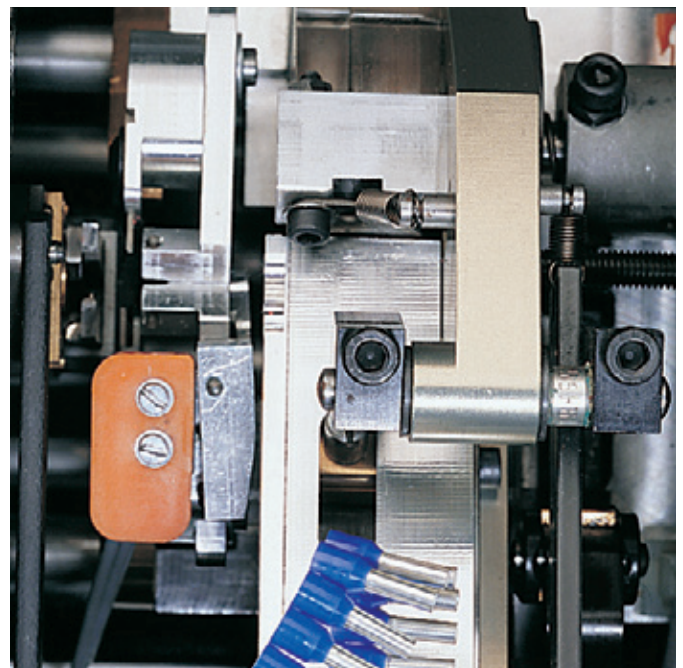
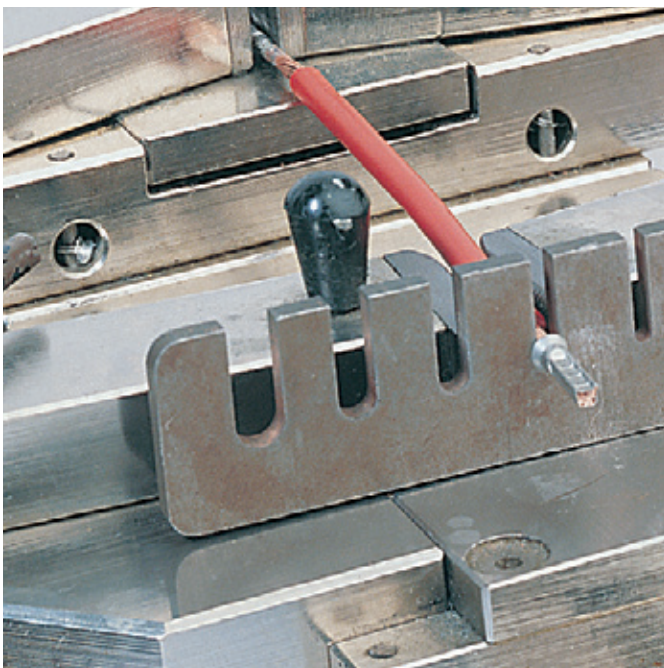

Weidmüller guarantees the functionality of its tools – in written form – with a comprehensive test certificate and a test label.

Furthermore, Weidmüller issues a laser-inscribed identification number to each tool leaving the factory; and on request, the tool is also supplied with the documentation for the customer's own DIN ISO 9001 quality control procedures.

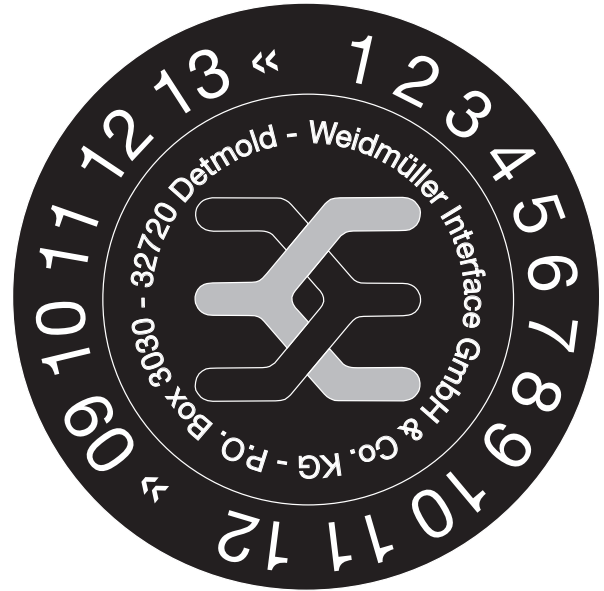

Prüfzeugnis Nr. 405706 Test report No.		 Weidmüller Interface GmbH & Co.KG Klingenbergr. 16 32768 Detmold Fax: 05231 / 14-0 Fax: 05231 / 14-1313		
Kunde: Customer:	Fa. Mustermann Musterstraße 3 12345 Musterstadt	Kunden-Nummer Customer No.:	12345	
Artikel-Bez.: Description	MTR 110 Zert.	Eingangsdatum: Date of delivery	24.11.2011	
Bestell-Nr.: Part-no.	9017490000	Auftrag/Retour Nr. Order No.:	12345678	
Fert.-Datum: Production Date:	4 Quartal 2009 Exz.-Stell. Excentric Pos.	Keine None	Empfohlene nächste Kalibrierung: Recommended next calibration:	
Funktionsprüfung i.O. Functional check passed:			Ja <input checked="" type="checkbox"/> X Yes	
Verwendete Meßmittel / Test Equipment Zug-Druck-Prüfmaschine/ Pull-Pressure Unit: Erichsen Unimat Plus 054 – 20 K		Nächste Kalibrierung/ calibration until 10/2012		
Lfd.-Nr. No.	Art der Prüfung of test	Kl. Vorgabe / Norm Specifications/Standards	Sollwert [N] Reference Value [N]	Istwert [N] Actual Value [N]
1	Ausziehkraftprüfung H07V-K 10 mm <sup>2</sup> Pull Out Force Test Einsatzpaar 10/70 9018400000	DIN EN 61238 Fa. Mustermann	≥ 600	1884
2	Ausziehkraftprüfung H07V-K 120 mm <sup>2</sup> Pull Out Force Test Einsatzpaar 120 9018440000	DIN EN 61238	≥ 7200	> 10000
3				
4				
5				
Prüfsiegel angebracht. Test-Seal attached.			Ja <input checked="" type="checkbox"/> X Yes	Nein No
Bemerkungen / Remarks: Crimpwerkzeug für nicht isolierte Kabelschuhe 6 ... 120 mm <sup>2</sup> . Kabelschuh gleichmäßig und ohne Beschädigung verpresst. Crimping Tool for uninsulated cable lugs 6 ... 120 mm <sup>2</sup> ; cable lugs are crimped constant without any defects.				
Dieses Dokument wurde maschinell erstellt und ist auch ohne Unterschrift gültig. This document was generated by machine and is also valid without signature.				
Das Werkzeug entspricht der oben genannten Norm. The tool confirmed to the norm.			Ja <input checked="" type="checkbox"/> X Yes	Nein No
Datum: Date:	23.01.2012	Prüfer: Tested by:	H. Hänsgen	

## It takes a manufacturer who knows his clients' work to develop just the right tools for the job.

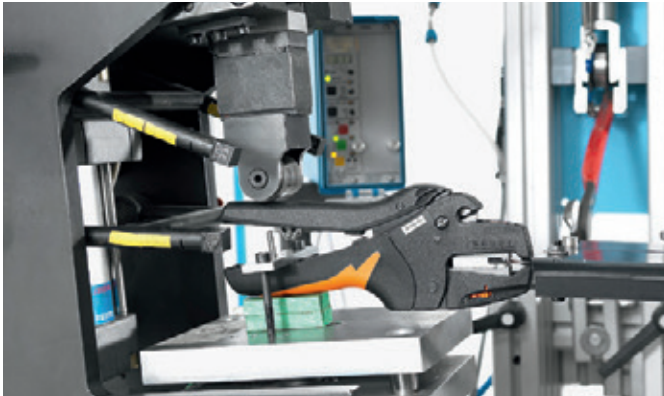

Testing the endurance of stripax® in the Weidmüller laboratory

Our professional tools are the result of an intensive development process, in direct response to customer feedback on the demands made of them in practice. Because, as a manufacturer, we believe that the right tools can only be developed for you if we are familiar with your business, understand your work processes and unrelentingly endeavour to help make them as effective as possible. In addition, a long tool lifespan and application-based functionality are just as important to us in our work as creating the perfect working conditions. A good tool has to fit snugly in your hand, which is why we attribute such importance to achieving the best possible ergonomics, optimally distributing a tool's weight and making it easy to use. This protects you and boosts your efficiency.

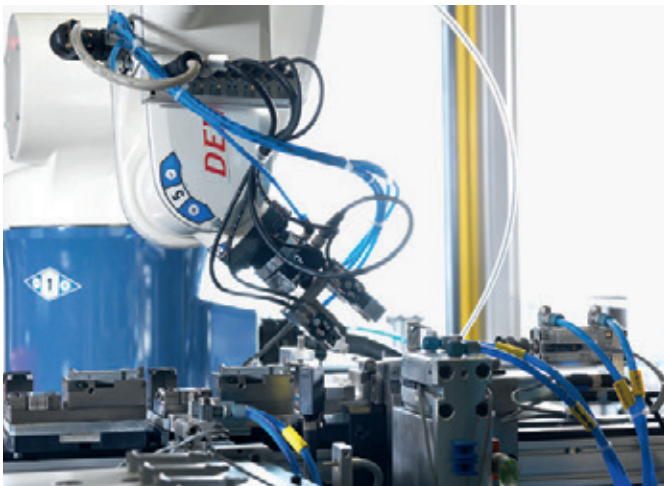

Ultra modern manufacture of precision parts

### Tested quality in all areas

We make sure that the quality of our tools is consistently maintained by subjecting them to rigorous tests in our own laboratory. This quality control process also incorporates the contacts and conductors that are worked on with our tools, and these undergo thorough testing together with our terminals.

Whether it's a test of insertability into the rated clamping space, a bending test or a test of the pull-out forces, the complex, cross-linked testing procedures give you the peace of mind that both products and tools will work together in harmony.

This means you can benefit from having precision tools that deliver unfailing functionality and excellent manageability. This in turn helps enable you to optimise your work processes and increase your productivity.

Products are invariably only as good as the tools with which they are processed. Which is why everything goes hand in hand at Weidmüller.

We have just the right tools for all your needs, covering everything from terminal mounting to the installation of sensitive electronic components.

We aim to simplify your work and help boost your profitability.



# Cutting

<b>Cutting</b>	Introduction	B.2
	Cutting tools	B.4
	Front cable cutter	B.6
	Cable cutter	B.7
	Cutting and releasing tools	B.9
	Mounting rail cutter	B.11
	Hydraulic hole puncher	B.13
	Electrician's knife / Electrician's scissors	B.16



## Cutting

A large number of cables and conductors in many different types and designs are used to connect electrical and electronic components. The cables and wires must be accurately prepared for the various types of connection. The quality of the cutting process is therefore of critical importance. Mechanical efficiency together with the special cutting pattern reduces the manual force required to a minimum.

Weidmüller is a specialist in the provision of tools for cutting copper or aluminium cables. Our product ranges include cutting tools for small cross-sections (with direct transmission of force) to cutting tools for large diameters. Indeed, our wide range of cutting tools fulfils all the criteria for cable preparation; easy to use and giving a smooth, straight cut, without deforming the conductor.





At Weidmüller the term “cutting” refers to the severing of cables, wires and conductors of copper or aluminium with an appropriate tool for the application. The requirement for all cutting tools is to perform a smooth, straight cut without deforming the conductor.

According to **DIN 8588**, experts differentiate between shear cutting, wedge-action cutting, tearing and breaking. Shear cutting is employed particularly in the cutting of cables, wires and conductors. Cutting tools with cross blades should perform an oblique cut and operate without play.

The essential quality characteristics for professional cutting tools are a cutting edge shape which is suited to, and optimised for, the corresponding application, so that the manual forces required for cutting remain low. This allows single-handed operation. Tools by Weidmüller comply with all requirements imposed on professional cutting tools.

**Movement of the blades**

We differentiate between two basic cutting processes:

- Push cut
- Draw cut

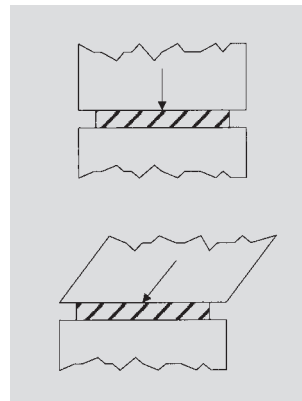

In **push cut**, the cutting movement is perpendicular between tool and workpiece.

In **draw cut**, the cutting movement is oblique to the tool.

**Clean cut**

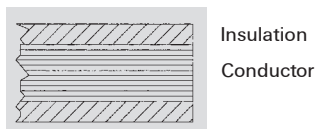

An “**unclean**” cut may have the following appearance:

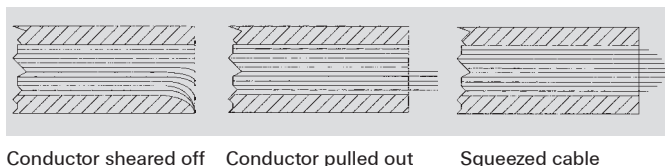

**Position of the blades**

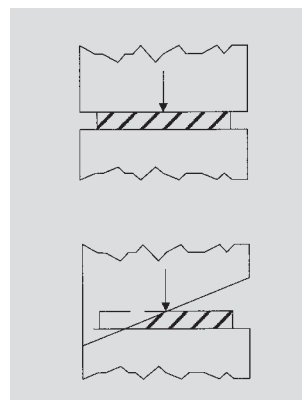

In **position 1** the blades act directly and over the whole length, i.e. considerable force is required.

In **position 2**, the blades cross as in a pair of scissors, the cut is therefore “offset” and requires less force.

## Cutting tools

### Cutting tools

- The cutting blade design for different cable sizes increases the quality of the cuts for smaller cross-sections
- Not suitable for steel wires, steel-armoured cables, aluminium alloys and hard-drawn copper conductors!
- Cutting without deformation of the conductor
- Do not cut live conductors
- Individually tested protective insulation, 1000V, VDE and GS tested in accordance with EN/IEC 60900
- Optimised handle ergonomics
- Minimal hand force required

### KT 8





### KT 12



 max. 8 mm

 max. 16 mm<sup>2</sup>

 max. 16 mm<sup>2</sup>

 max. 16 mm<sup>2</sup>

 max. 12 mm

 max. 16 mm<sup>2</sup>

 max. 25 mm<sup>2</sup>

 max. 35 mm<sup>2</sup>

### Technical data

Max. cutting performance, copper cable	
Copper cable - solid, max.	mm <sup>2</sup> /-
Copper cable - stranded, max.	mm <sup>2</sup> /-
Copper cable - flexible, max.	mm <sup>2</sup> /-
Copper cable, max. diameter	mm
Max. cutting performance, aluminium cable	
Stranded aluminium cable, max (mm <sup>2</sup> )	mm <sup>2</sup> /-
Stranded aluminium cable, max. diameter	mm
Single-core aluminium cable, max.(mm <sup>2</sup> )	mm <sup>2</sup>
Data / telephone / control cable	
Data / telephone / control cable, max. Ø	mm
Tool data	
Length / Width / Height	mm
Weight	g
Note	

### Ordering data

Version
Note

KT8		
16		
16 / 6		
16 / 6		
8		
16 / 6		
8		
185 / 65.5 / 30		
180		
Tool closed		

Type	Qty.	Order No.
KT 8	1	9002650000
Note		

KT12		
16		
25 / 3		
35 / 2		
12		
25 / 6		
8		
25		
12		
225 / 63.5 / 30		
300		
Tool closed		

Type	Qty.	Order No.
KT 12	1	9002660000
Note		



## Cutting tools

- Not suitable for steel wires, steel-armoured cables, aluminium alloys and hard-drawn copper conductors!
- Cutting without deformation of the conductor
- Do not cut live conductors
- Individually tested protective insulation, 1000V, VDE and GS tested in accordance with EN/IEC 60900
- Optimised handle ergonomics
- Minimal hand force required

## KT 14



-  max. 14 mm
-  max. 16 mm<sup>2</sup>
-  max. 35 mm<sup>2</sup>
-  max. 70 mm<sup>2</sup>

## KT 22



-  max. 22 mm
-  max. 25 mm<sup>2</sup>
-  max. 50 mm<sup>2</sup>
-  max. 95 mm<sup>2</sup>

## Technical data

Max. cutting performance, copper cable	
Copper cable - solid, max.	mm <sup>2</sup> /-
Copper cable - stranded, max.	mm <sup>2</sup> /-
Copper cable - flexible, max.	mm <sup>2</sup> /-
Copper cable, max. diameter	mm
Max. cutting performance, aluminium cable	
Stranded aluminium cable, max (mm <sup>2</sup> )	mm <sup>2</sup> /-
Stranded aluminium cable, max. diameter	mm
Single-core aluminium cable, max.(mm <sup>2</sup> )	mm <sup>2</sup>
Data / telephone / control cable	
Data / telephone / control cable, max. Ø	mm
Tool data	
Length / Width / Height	mm
Weight	g
Note	

## Ordering data

Version
Note

16
35 / 2
70 / 2/0
14
70 / 2/0
14
35
14
225 / 63.5 / 30
320
Tool closed

Type	Qty.	Order No.
KT 14	1	1157820000
Note		
Single-core aluminium cable corresponds to single-wire sector cable		

25
50 / 1
95 / 3/0
22
70 / 2/0
22
50
22
245 / 71.5 / 31
460
Tool closed

Type	Qty.	Order No.
KT 22	1	1157830000



## Front cable cutter

### Front cable cutter

- Suitable in situations where cables have to be cut in confined spaces
- Easy handling
- Minimal hand force required
- Release option in every cutting position
- Not suitable for steel wires, steel-armoured cables, aluminium alloys and hard-drawn copper conductors!
- Do not cut at live conductors



### KTF 25



-  Cu + Al: max. 25 mm
-  Cu: max. 120 mm<sup>2</sup>  
Al: max. 150 mm<sup>2</sup>
-  Cu: max. 120 mm<sup>2</sup>

### KTF 36



-  Cu + Al: max. 35 mm
-  Cu: max. 300 mm<sup>2</sup>  
Al: max. 300 mm<sup>2</sup>
-  Cu: max. 300 mm<sup>2</sup>

### Technical data

Max. cutting performance, copper cable	
Copper cable - stranded, max.	mm <sup>2</sup> /kcmil
Copper cable - flexible, max.	mm <sup>2</sup> /kcmil
Copper cable, max. diameter	mm
Copper sector cable	
Max. cutting performance, aluminium cable	
Stranded aluminium cable, max (mm <sup>2</sup> )	mm <sup>2</sup> /kcmil
Stranded aluminium cable, max. diameter	mm
Aluminium sector cable	
Data / telephone / control cable	
Data / telephone / control cable, max. Ø	mm
Tool data	
Length / Width / Height	mm
Weight	g
-	
Note	

### Ordering data

Version
Note

KTF 25		
		120
		120 / 250
		25
		150 / 300
		25
		25
		245 / 80 / 40
		900
		Tool closed

Type	Qty.	Order No.
KTF 25	1	9002180000
Note		

KTF 36		
		300
		300 / 600
		35
		300 / 600
		35
		35
		330 / 100 / 49
		1400
		Tool closed

Type	Qty.	Order No.
KTF 36	1	9002190000
Note		

**Cable cutter**



- One-hand operation
- Easy handling
- Minimal hand force required
- Release option in every cutting position
- Not suitable for steel wires, steel-armoured cables, aluminium alloys and hard-drawn copper conductors!
- Do not cut at live conductors

**KT 45 R**





**KT 55**



-  Cu + Al: max. 45 mm
-  Cu: max. 300 mm<sup>2</sup>  
Al: max. 400 mm<sup>2</sup>
-  Cu: max. 400 mm<sup>2</sup>



-  Cu + Al: max. 55 mm
-  Cu: max. 500 mm<sup>2</sup>  
Al: max. 500 mm<sup>2</sup>
-  Cu: max. 500 mm<sup>2</sup>



**Technical data**

Max. cutting performance, copper cable	
Copper cable - stranded, max.	mm <sup>2</sup> /kcmil
Copper cable - flexible, max.	mm <sup>2</sup> /kcmil
Copper cable, max. diameter	mm
Copper sector cable	
Max. cutting performance, aluminium cable	
Stranded aluminium cable, max (mm <sup>2</sup> )	mm <sup>2</sup> /kcmil
Stranded aluminium cable, max. diameter	mm
Aluminium sector cable	
Data / telephone / control cable	
Data / telephone / control cable, max. Ø	mm
Tool data	
Length / Width / Height	mm
Weight	g
-	
Note	

KT 45 R	
300	
400 / 800	
45	
3 x 70 SM	
400 / 800	
45	
4 x 70 SE	
45	
290 / 85 / 40	
740	
Note	

KT 55	
500	
500 / 1000	
55	
3 x 150 SM	
500 / 1000	
55	
4 x 150 SE	
55	
365 / 115 / 45	
1450	
Note	

**Ordering data**

Version
Note

Type	Qty.	Order No.
KT 45 R	1	9202040000
The dimensions of the cable cutter refer to the delivery condition, i.e. the point of the hinged blade parallel to the fixed blade.		

Type	Qty.	Order No.
KT 55	1	9202060000
The dimensions of the cable cutter refer to the delivery condition, i.e. the point of the hinged blade parallel to the fixed blade.		

**Accessories**

Type	Qty.	Order No.
ERME KT 45 R	1	9204270000
Spare pivoting cutter		
Note		

Type	Qty.	Order No.
ERME KT 55	1	9204280000
Spare pivoting cutter		
Note		

## Cable cutter



### Cable cutter

- Easy handling
- Minimal hand force required
- Release option in every cutting position
- Not suitable for steel wires, steel-armoured cables, aluminium alloys and hard-drawn copper conductors!
- Do not cut at live conductors



### KT 80



-  Cu + Al: max. 80 mm
-  Cu: max. 630 mm<sup>2</sup>  
Al: max. 1.000 mm<sup>2</sup>
-  Cu: max. 630 mm<sup>2</sup>



### Technical data

Max. cutting performance, copper cable	
Copper cable - stranded, max.	mm <sup>2</sup> /kcmil
Copper cable - flexible, max.	mm <sup>2</sup> /kcmil
Copper cable, max. diameter	mm
Copper sector cable	
Max. cutting performance, aluminium cable	
Stranded aluminium cable, max (mm <sup>2</sup> )	mm <sup>2</sup> /kcmil
Stranded aluminium cable, max. diameter	-
Aluminium sector cable	
Data / telephone / control cable	
Data / telephone / control cable, max. Ø	mm
Tool data	
Length / Width / Height	mm
Weight	g
-	
Note	

### Ordering data

Version
Note

### Accessories

Type	Qty.	Order No.
ERME KT 80	1	9204290000
Spare pivoting cutter		
Note		

KT 80		
630		
630 / 1260		
80		
3 x 240 SM		
1000 / 2000		
4 x 240 SE		
80		
675 / 175 / 55		
3240		
Note		

Type	Qty.	Order No.
KT 80	1	9202080000
The dimensions of the cable cutter refer to the delivery condition, i.e. the point of the hinged blade parallel to the fixed blade.		

Type	Qty.	Order No.
ERME KT 80	1	9204290000
Spare pivoting cutter		

**Cutting and releasing tools**

Special release tool for the Weidmüller W-Series terminal connectors.

**WAW 1**

Notching tool



Tool for releasing poles from WQV 2.5 to WQV 35 cross connections used in Weidmüller W-Series terminal connectors.

**WAW 2**

Notching tool



Tool for punching out the cross-connection windows of the Weidmüller W-Series terminal connectors  
WTR 2.5 disconnect terminal  
WSI 6 fuse terminal

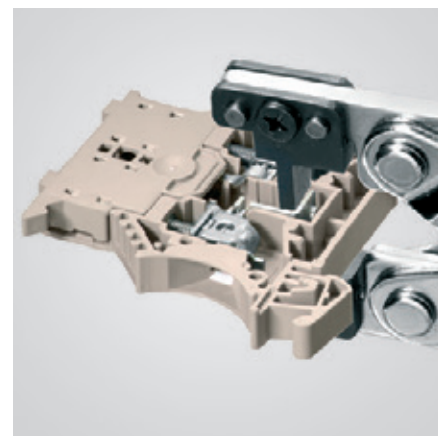

**Technical data**

Length	mm
Weight	g
Note	

<b>WAW 1</b>		
Length	mm	167
Weight	g	227
Note		

<b>WAW 2</b>		
Length	mm	205
Weight	g	338
Note		

**Ordering data**

Version	
Note	

Type	Qty.	Order No.
WAW 1 NEUTRAL	1	9004500000
Note		

Type	Qty.	Order No.
WAW 2	1	9004510000
Note		

## Cutting and releasing tools

### Cutting and releasing tools

Special cutting tool for clean pinch-free cutting of Weidmüller Z-Series cross-connections

#### KT ZQV

##### Cutting tool



Cutting tool for clean cutting of Weidmüller Z-Series cross-connections

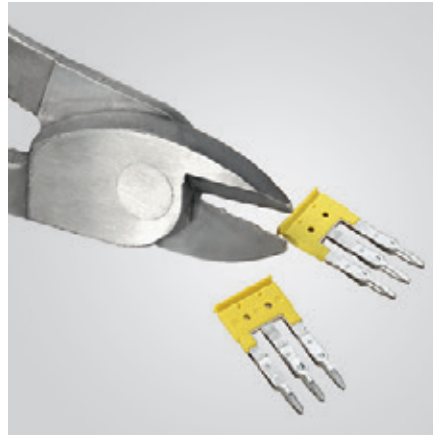

#### Technical data

Length	mm
Weight	g
<b>Note</b>	

#### Ordering data

<b>Version</b>	
<b>Note</b>	

<b>KT ZQV</b>		
Length	215	
Weight	300	
<b>Note</b>		

Type	Qty.	Order No.
KT ZQV	1	9002170000
A large selection of cross-connectors can be found in our current Modular Terminals Catalogue.		

#### VKSW

##### Wire channel cutter



Manually-operated wire channel cutter for cutting wire channels and covers up to a width of 125 mm.

- Cutting with no burrs or waste
- Longitudinal stop (1000 mm) with guide for precision angling
- Table-top unit for mounting on workbench or similar workplaces
- Hardened cutting edges made from special steel

<b>VKSW</b>		
Length	280	
Weight	15000	
<b>Note</b>		

Type	Qty.	Order No.
VKSW	1	1137530000
ERME VKSW	1	1251270000

TSLD

TSLD

Terminal rail cutting and punching tool



Hand-operated mounting rail cutter for cutting and perforating DIN mounting rails

- Cutting with no burrs or waste
- Length end stop (1000 mm) is included in delivery
- Table-top unit for mounting on workbench or similar workplaces

**Note on TSLD C:**

G profile is replaced by C profile.  
C profile is individually adapted according to pattern.



Copper earthing bar



TS 32 mm according to EN 50035 (s = 1.5 mm)



TS 15/5.5 mm according to EN 50045 (s = 1.0 mm)



TS 35/7.5 mm according to EN 50022 (s = 1.0 mm)



TS 35/15 mm according to EN 50022 (s = 1.5 mm)

**Technical data**

Width	mm
Length	mm
Height	mm
Weight	g
<b>Note</b>	

<b>TSLD 5</b>		
Width	mm	205
Length	mm	270
Height	mm	200
Weight	g	19000
<b>Note</b>		
Technical data without lever and length end stop		

**Ordering data**

<b>Version</b>	
<b>Note</b>	

Type	Qty.	Order No.
TSLD 5	1	9918700000
TSLD C	1	1270310000
<b>Note</b>		
A large selection of mounting rails can be found in our current Terminal Connectors Catalogue.		

## Mounting rail cutter

## TSD 35

## TSD 35

## Mounting rail cutter

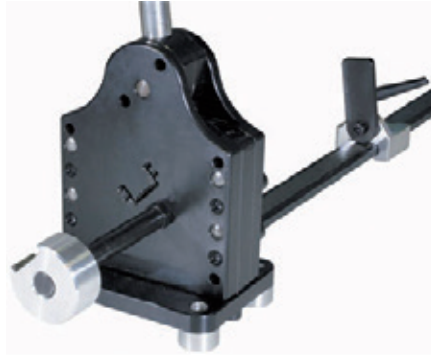

TS 35/7.5 mm according to EN 50022 (s = 1.0 mm)



TS 35/15 mm according to EN 50022 (s = 1.5 mm)

Hand-operated mounting rail cutter for cutting DIN mounting rails

- Cutting with no burrs or waste
- Length end stop is included in delivery
- Table-top unit for mounting on workbench or similar workplaces

## Technical data

Width	mm
Length	mm
Height	mm
Weight	g
<b>Note</b>	

<b>TSD 35</b>
205
270
200
16000
Technical data without lever and length end stop

## Ordering data

<b>Version</b>
<b>Note</b>

Type	Qty.	Order No.
TSD 35	1	1318510000
A large selection of mounting rails can be found in our current Terminal Connectors Catalogue.		



## Hydraulic hole puncher

The IP protection classes for housings, cable glands, heavy-duty connectors and Industrial Ethernet connectors can only be maintained under two conditions: the sheet metal must not be bent during the punching process and the size of the punched-out holes must correspond precisely with the specifications. The IE-KO-HAT hydraulic sheet metal hole puncher, together with its accessories, guarantees you the highest quality workmanship available. It ensures that the connector fits precisely with the punched-out holes so that you can fulfill the proper IP protection class requirements.



The hydraulic hole puncher punches out precise holes for accommodating metric and PG cable glands.



Automatic centre punching at the drill points when punching out holes for heavy-duty connectors.

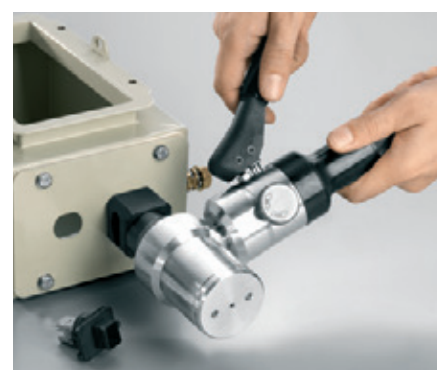

Punching out holes for a variety of industrial Ethernet connectors.

The table below lists the round splitting stamps and their corresponding tension screws – for manual use and for use with the hydraulic screws

Type	Descriptions	Dimension	Order No.	Tension screw Ø x l in mm	Order No.	Hydraulic screw (tension bolt) Ø in mm	Order No.
KOS M 16	Round splitting stamp for M16 cable glands	Ø 16,2 mm	9204880000	9,5 x 50	9205030000	19 x 9,5	9205000000
KOS M 20	Round splitting stamp for M20 cable glands	Ø 20,4 mm	9204950000	9,5 x 50	9205030000	19 x 9,5	9205000000
KOS M 25	Round splitting stamp for M25 cable glands	Ø 25,4 mm	9204900000	9,5 x 50	9205030000	19 x 9,5	9205000000
KOS M 32	Round splitting stamp for M32 cable glands	Ø 32,5 mm	9204910000	19,0 x 55	9205040000	19	9205010000
KOS M 40	Round splitting stamp for M40 cable glands	Ø 40,5 mm	9204920000	19,0 x 75	9204780000	19	9205010000
KOS PG 9	Round splitting stamp for PG9 cable glands	Ø 15,2 mm	9204930000	9,5 x 50	9205030000	19 x 9,5	9205000000
KOS PG 11	Round splitting stamp for PG11 cable glands	Ø 18,6 mm	9204940000	9,5 x 50	9205030000	19 x 9,5	9205000000
KOS PG 13	Round splitting stamp for PG13 cable glands	Ø 20,4 mm	9204950000	9,5 x 50	9205030000	19 x 9,5	9205000000
KOS PG 16	Round splitting stamp for PG16 cable glands	Ø 22,5 mm	9204960000	9,5 x 50	9205030000	19 x 9,5	9205000000
KOS PG 21	Round splitting stamp for PG21 cable glands	Ø 28,3 mm	9204970000	9,5 x 50	9205030000	19 x 9,5	9205000000
KOS PG 29	Round splitting stamp for PG29 cable glands	Ø 37,0 mm	9204980000	19,0 x 55	9205040000	19	9205010000
KOS PG 36	Round splitting stamp for PG36 cable glands	Ø 47,0 mm	9204990000	19,0 x 75	9204780000	19	9205010000

**Information:** Hydraulic screw included in the IE-KO-HAT set.  
Tension screws only used for manual operation.

## Hydraulic hole puncher

### Hydraulic sheet holes

Incl. accessories:

- 1 hydraulic screw  $\varnothing$  19 mm
- 1 hydraulic screw  $\varnothing$  19 x 9.5 mm
- 1 HSS pre-drill  $\varnothing$  10 mm
- 1 spacer nut set (3-part)
- 1 bridge

### IE-KO-HAT



- Overpressure valve protects against overloading
- Cylinder head angled 90°
- Angled head can be rotated through 360°
- Ergonomic handle springs back automatically
- The piece of waste no longer becomes jammed thanks to 3-fold cleaving
- Hydraulic punch manufactured from high-strength aluminium (approx. 40% less weight)

### Technical data

Maximum steel-sheet punching performance	
Round holes from 1 to $\varnothing$ 85 mm	-
Round holes from 2 to $\varnothing$ 64 mm	-
Square holes up to	-
Rectangular holes up to	-
Maximum stainless steel sheet punching performance	
Round holes from 3 to $\varnothing$ 64 mm	-
Tool data	
Length x width x height	mm
Weight	kg
Punching force	kN
Max. operating pressure	bar
Note	

### Ordering data

Version
Note

### Accessories

Type	Qty.	Order No.
KOHS 19	1	9205010000
KOHS 9.5+19	1	9205000000
KOPD 10.0	1	9205020000
Splitting stamp on the next page		
Note		

IE-KO-HAT	
2,0 mm F = 370 N/mm <sup>2</sup>	
3,0 mm F = 370 N/mm <sup>2</sup>	
68 x 68 mm; 2,0 mm F = 370 N/mm <sup>2</sup>	
36 x 112 mm; 2,0 mm F = 370 N/mm <sup>2</sup>	
2,5 mm F = 600 N/mm <sup>2</sup>	
290 / 120 / 70	
1.9	
75	
650	
Note	

Type	Qty.	Order No.
IE-KO-HAT	1	1966810000
Note		

Type	Qty.	Order No.
KOHS 19	1	9205010000
KOHS 9.5+19	1	9205000000
KOPD 10.0	1	9205020000
Splitting stamp on the next page		
Note		

Custom stamp for Industrial Ethernet connections



Type	Description	Dimensions	Qty.	Order No.
IE-KOK-V1	Custom shape for Bajonet 01 metal	Ø 27 mm x 1-seitig 25,9 mm	1	1966780000
IE-KOK-V4	Custom shape for Push Pull V04 plastic	Ø 23,2 mm x 2-seitig 20,2 mm	1	1966790000
IE-KOK-V5	Custom shape for RockStar® V05 metal	22,0 x 22,0 mm	1	9204790000
IE-KOK-V14	Custom shape for V14 flange	22,0 x 18,5 mm	1	1135240000

Rectangular splitting stamp for heavy-duty connectors



Type	Description	Dimensions	Size	Qty.	Order No.
KOK 52 x 36	Splitting stamp for 6-pole heavy-duty connectors	52,0 x 36 mm	3	1	9204820000
KOK 65 x 36	Splitting stamp for 10-pole heavy-duty connectors	65,0 x 36 mm	4	1	9204830000
KOK 86 x 36	Splitting stamp for 16-pole heavy-duty connectors	86,0 x 36 mm	6	1	9204850000
KOK 91 x 36	Splitting stamp for 16-pole heavy-duty connectors	91,0 x 36 mm	1	1	9204860000
KOK 112 x 36	Splitting stamp for 24-pole heavy-duty connectors	112,0 x 36 mm	8	1	9204870000
KOK 52 x 91	Splitting stamp forFrontCom Vario	52,0 x 91 mm		1	2008410000

Rectangular splitting stamp for switches



Type	Description	Dimensions	Qty.	Order No.
KOK 46 x 46	Rectangular splitting stamp for switches	46,0 x 46,0 mm	1	9204810000
KOK 68 x 68	Rectangular splitting stamp for switches	68,0 x 68,0 mm	1	9204840000
KOK 92 x 92	Rectangular splitting stamp for switches	92,0 x 92,0 mm	1	2008420000

Round splitting stamp for metric cable glands



Type	Description	Dimensions	Qty.	Order No.
KOS M 16	Round splitting stamp for M16 cable glands	Ø 16,2 mm	1	9204880000
KOS M 20	Round splitting stamp for M20 cable glands	Ø 20,4 mm	1	9204950000
KOS M 25	Round splitting stamp for M25 cable glands	Ø 25,4 mm	1	9204900000
KOS M 32	Round splitting stamp for M32 cable glands	Ø 32,5 mm	1	9204910000
KOS M 40	Round splitting stamp for M40 cable glands	Ø 40,5 mm	1	9204920000

Round splitting stamp for high-strength cable glands



Type	Description	Dimensions	Qty.	Order No.
KOS PG 9	Round splitting stamp for PG9 Cable glands	Ø 15,2 mm	1	9204930000
KOS PG 11	Round splitting stamp for PG11 Cable glands	Ø 18,6 mm	1	9204940000
KOS PG 13	Round splitting stamp for PG13 Cable glands	Ø 20,4 mm	1	9204950000
KOS PG 16	Round splitting stamp for PG16 Cable glands	Ø 22,5 mm	1	9204960000
KOS PG 21	Round splitting stamp for PG21 Cable glands	Ø 28,3 mm	1	9204970000
KOS PG 29	Round splitting stamp for PG29 Cable glands	Ø 37,0 mm	1	9204980000
KOS PG 36	Round splitting stamp for PG36 Cable glands	Ø 47,0 mm	1	9204990000

Tension screw



Type	Description	Dimensions	Qty.	Order No.
KOBBS	Tension screw	9,5 x 50 mm	1	9205030000
KOBBS	Tension screw	19 x 55 mm	1	9205040000
KOBBS	Tension screw	19 x 75 mm	1	9204780000

**SLICER 1K**

Electrician's knife



- Lock-blade knife with plastic handle
- Rust-proof
- With round and triangular notch

**SLICER 2K**

Electrician's knife



- Lock-blade knife with plastic handle
- Electrician blade with 2 notches and lock
- Curved blade, part of which is finely serrated
- Rust-proof

**SCISSOR 1K**

Electrician's scissors



- With wire cutter
- Handles made from shockproof polyamide
- Cutting edges with high-gloss chromate finish

**Ordering data**

Type	Qty.	Order No.
SLICER 1K	1	9918160000

**Ordering data**

Type	Qty.	Order No.
SLICER 2K	1	9041600000

**Ordering data**

Type	Qty.	Order No.
SCISSOR 1 K	1	9918690000

### SCISSOR 2K

Electrician's scissors



- With wire cutter
- Serrated cutting edge
- Rust-proof
- Soft-touch handle for firm grip

### SCISSOR KEVLAR



- Cable shears specially designed for aramid fibres
- Only for cutting aramid fibres (strain relief in fibre-optic cables)
- Do not use for other materials
- Special blade geometry
- Blades ground
- With teeth on the cutting edge
- Riveted joint
- Hand-friendly, impact-resistant plastic handles

#### Ordering data

Type	Qty.	Order No.
SCISSOR 2 K	1	9918230000

#### Ordering data

Type	Qty.	Order No.
SCISSORS KEVLAR	1	1208910000



# Stripping

<b>Stripping</b>	Introduction	C.2
	Stripping and cutting tools	C.4
	Sheathing strippers	C.12

## Stripping

After a conductor has been cut it is then prepared for the next step or for crimping. For this purpose, a specific length of the conductor insulation has to be removed, while preventing damage to the conductor. The length of the conductor insulation to be removed depends on the terminal clamping point or the crimp to be processed.

Professional stripping tools guarantee perfect results due to precise adjustment of the tool to the corresponding insulation and the conductor cross-section.

Precision tools by Weidmüller guarantee that the user will always obtain consistent, reliable stripping results.

“Stripping” means the cutting and removal of the insulation. The following must be ensured in performing this task.

The stripping dimension must be observed and neither the conductor nor the remaining insulation must be damaged.

To avoid mistakes, use a stripping tool matched to the insulation and cross-section of the conductor.

Do not use work knives or penknives because the stripping quality when using such tools depends entirely on the manual dexterity of the user. The quality is not consistent, even when the user is highly skilled.

Preference should be given to hand-operated tools that adjust automatically to the corresponding cross-section of the conductor. They do not damage to the conductor during stripping and avoid faults.

stripax® stripping tools guarantee a consistent stripping result which complies with DIN regulations. The tools are rated for standard dimension PVC insulation. Any PVC insulation thicknesses deviating from normal can be set manually. The conductor stopper and integrated wire cutter allow highly versatile use of the tools.

Special insulation types such as Teflon, Silicone and Kapton require special stripping tools. These tools strip the conductor with punch blades.







**DIN IEC 60352 part 2 contains references to stripping faults which must be avoided:**

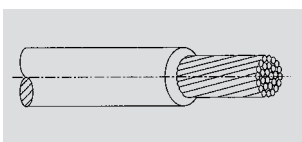

**Correctly** stripped conductor

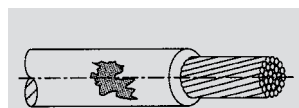

The conductor insulation has been damaged by the stripping tool

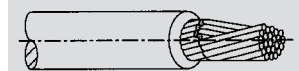

Single conductors have been damaged or cut off by the stripping tool



Insulation has not been cut properly

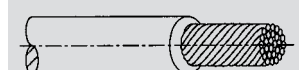

Single conductors have been twisted too tightly afterwards

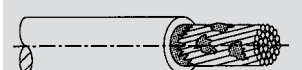

Remains of the conductor insulation are still to be found on the stripped conductor

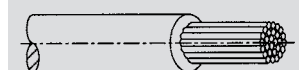

Single conductors are no longer twisted.

Stripping and cutting tools

Stripping and cutting tools

- For flexible and solid conductors
- Double-insulated cables in two process steps without special adjustment
- Automatic opening of clamping jaws after stripping
- No play in self-adjusting cutting unit
- Long service life
- No fanning-out of individual conductors
- Optimised ergonomic design
- Stripping length adjustable via end stop
- Adjustable to diverse insulation thicknesses
- Selectable partial stripping
- Removable handle shells
- Fold-out cutting protection
- Personalised marking with ESG device marker

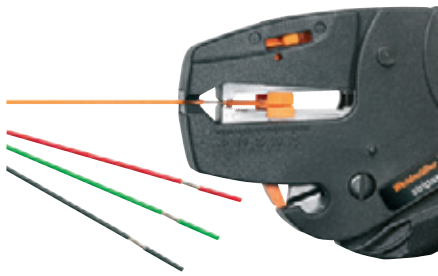

stripax®

0.08...10 mm<sup>2</sup>



- Stripping: PVC-insulated flexible conductors, ranging from 0.08...10 mm<sup>2</sup> (~AWG 28...7)
- Cutting: PVC-insulated flexible conductors, ranging from 0.08...6 mm<sup>2</sup> (~AWG 28...7)
- Processing of multi-conductors, with thin flat ribbon cables even several conductors in one operation
- No damage to the conductors due to special, self-adjusting stripping blades



stripax® 16

6...16 mm<sup>2</sup>



- Stripping: PVC-insulated flexible and solid conductors from 6...16 mm<sup>2</sup> (~AWG 10... 6)
- Cutting: PVC insulated flexible and solid conductors up to 6 mm<sup>2</sup> (AWG 10)
- No damage to the conductor thanks to specially shaped blade



Technical data

Max. stripping performance	
Cable type	
Wire cross-section, min. / max.	
Stripping length, max.	mm
Cutting performance	
Conductor cross-section (cutting capacity)	mm <sup>2</sup>
Tool data	
Length	mm
Weight	g
Note	

Ordering data

Version
Note

Accessories

Type	Qty.	Order No.
ERME 10 <sup>2</sup> SPX 4	1	1119030000
Note		

STRIPAX		
Flexible and solid conductors with PVC insulation		
0.08...10		
25		
6		
190		
175		
Type	Qty.	Order No.
STRIPAX	1	9005000000
STRIPAX ZERT	1	9017330000
Note		

Type	Qty.	Order No.
STRIPAX 16	1	9005610000
Note		

Type	Qty.	Order No.
ERME 16 <sup>2</sup> SPX 4	1	1119040000
Note		

STRIPAX 16		
Flexible and solid conductors with PVC insulation		
6...16		
25		
6		
190		
175		
Type	Qty.	Order No.
STRIPAX 16	1	9005610000
Note		

Type	Qty.	Order No.
ERME 16 <sup>2</sup> SPX 4	1	1119040000
Note		

**Stripping tools with automatic self-adjustment**

- For flexible and solid conductors
- Ideally suitable for mechanical and plant engineering, railway and rail traffic, wind energy, robot technology, explosion protection as well as marine, offshore and ship building sectors
- Stripping length adjustable via end stop
- Automatic opening of clamping jaws after stripping
- No fanning-out of individual conductors
- Adjustable to diverse insulation thicknesses
- Double-insulated cables in two process steps without special adjustment
- No play in self-adjusting cutting unit
- Long service life
- Optimised ergonomic design
- Selectable two-stage partial stripping



**Technical data**

Max. stripping performance	
Cable type	
Wire cross-section, min. / max.	
Stripping length, max.	mm
Cutting performance	
Conductor cross-section (cutting capacity)	mm <sup>2</sup>
Tool data	
Length	mm
Weight	g
Note	

**Ordering data**

Version
Note

**Accessories**

Type	Qty.	Order No.
ERME SPX UL	1	1471390000
Note		

**stripax® Ultimate**

0.25...6 mm<sup>2</sup>



- Stripping and cutting of flexible and solid conductors from 0.25...6 mm<sup>2</sup> (~AWG 24... 10)
- Especially suitable for UL-specified conductors and halogen-free insulation materials



**STRIPAX ULTIMATE**

Flexible and solid conductors with halogen-free insulation		
Wire cross-section, min. / max.	0.25...6	
Stripping length, max.	25	
Cutting performance		
Conductor cross-section (cutting capacity)	6	
Tool data		
Length	190	
Weight	175	
Note		

Type	Qty.	Order No.
STRIPAX ULTIMATE	1	1468880000
Note		

Type	Qty.	Order No.
ERME SPX UL	1	1471390000
Note		

**stripax® Ultimate XL**

2.5-10 mm<sup>2</sup>



- Stripping and cutting of flexible and solid conductors from 2,5 ... 10 mm<sup>2</sup> (~AWG 14 - 8)
- Especially suitable for UL-specified conductors and halogen-free insulation materials



**STRIPAX ULTIMATE XL**

Flexible and solid conductors with halogen-free insulation		
Wire cross-section, min. / max.	2.5...10	
Stripping length, max.	25	
Cutting performance		
Conductor cross-section (cutting capacity)	6	
Tool data		
Length	190	
Weight	175	
Note		

Type	Qty.	Order No.
STRIPAX ULTIMATE XL	1	1512780000
Note		

Type	Qty.	Order No.
ERME SPX UL XL	1	1512790000
Note		

Stripping and cutting tools

Stripping and cutting tool for conductors with special insulation Types for conductor diameters 0.2 ... 1.21 mm (~ AWG 32 ... 18)

- Flexible and solid conductors with PVC, Teflon (PTFE) and silicone insulation
- Special stripping blades do not damage the conductor
- No splicing of the single conductors
- Blade inserts can be easily replaced
- All inserts fit one housing

Mini-duro-stripax®

Blade set



Technical data

Max. stripping length	
Stripping diameter max. cutting performance	mm
<b>Tool data</b>	
Length	mm
Weight	g
<b>Selection of blade sets</b>	
	Colour blade set
	mm (min./max.)
Conductor diameter	AWG
	mm <sup>2</sup>
	Insulation material

<b>Mini-duro-stripax®</b>						
3-7						
2,2						
135						
110						
	white	yellow	red	green	blue	black
	0,3-1,3	0,2-0,3	0,3-0,5	0,55-0,8	0,88-0,92	1,0-1,21
	28 ...18	32/1, 32/7, 30/1, 30/7	28/1, 28/7, 28/19, 26/1, 26/7, 26/19, 24/1	24/7, 24/19, 22/1, 22/7, 22/19, 20/1	20/7, 20/19	18/1, 18/7, 18/19
	≈ 0,08 ... 1,0					
	PVC / silicone	PTFE	PTFE	PTFE	PTFE	PTFE

Information

Ordering data

<b>Tools with blade set</b>
<b>Tool with all blade sets</b>

<b>Order No.</b> 9001280000	<b>Order No.</b> 9003700000	<b>Order No.</b> 9003710000	<b>Order No.</b> 9003720000	<b>Order No.</b> 9003730000	<b>Order No.</b> 9003740000
<b>Order No.</b> 9003500000					

Accessories

Blade set
Information

<b>Order No.</b> 9006970000	<b>Order No.</b> 9003600000	<b>Order No.</b> 9003610000	<b>Order No.</b> 9003620000	<b>Order No.</b> 9003630000	<b>Order No.</b> 9003640000
Information					





# multi-stripax®

Stripping is the name given to the cutting and removal of conductor insulation. When carrying out this task it must be guaranteed that the appropriate length of insulation is removed and that neither the conductor nor the remaining insulation are damaged in any way.

### The challenge



DIN IEC 352 part 2 (formerly DIN IEC 48/290) contains details of the stripping faults to avoid.

C

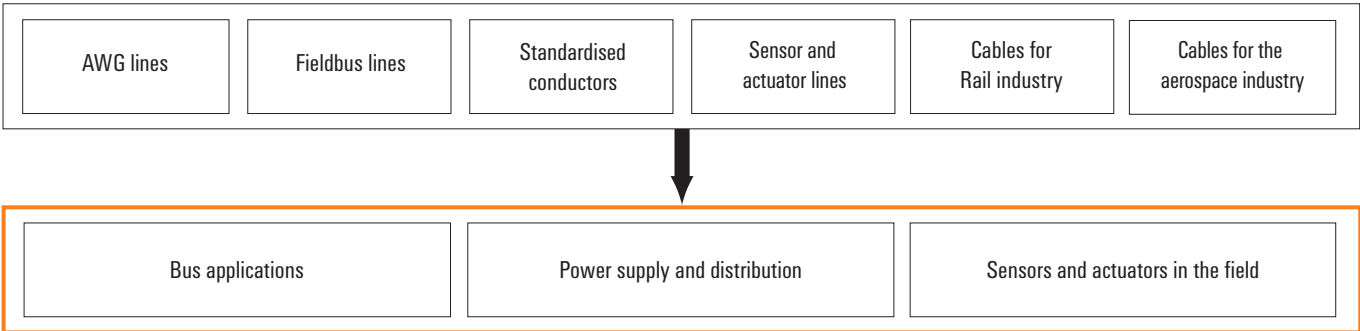

**multi-stripax®**

**Multifunctional stripping tool for use on a multitude of conductor insulation forms and configurations – even those not covered by the standard**

**multi-stripax® the troubleshooter**

- Interchangeable stripping units
- Proper stripping of any conductor round, flat or special profiles, thanks to the specially shaped stripping blades
- Incorporates cutting function for up to 2.5 mm<sup>2</sup> solid and 6 mm<sup>2</sup> fine
- Fatigue free operation thanks to ergonomic design
- No damage to conductor or remaining insulation
- Best stripping results for industrial applications
- Stripping results reproduced accurately time and time again
- A long lasting, reliable tool thanks to its robust design
- Plus, the customary Weidmüller repair service

**Special stripping units – the answer to diverse stripping tasks**

The multi-stripax® tool, distinguished by its robust design was developed, following customer feedback, to handle all the stripping tasks they have met with in practice.

Thanks to the interchangeable stripping units, a special solution can be found for every challenge in the marketplace.

The specially shaped stripping blades guarantee perfect stripping results. The guide plates ensure the correct positioning of the wire and therefore prevent damage to the remaining wire. The clamping jaws hold the conductor with just the right force during the stripping operation and are matched to the specific situation at hand. The flexibility of the multi-stripax® to affect the result of the stripping operations depending on the different variables it encounters makes it a universal troubleshooter.

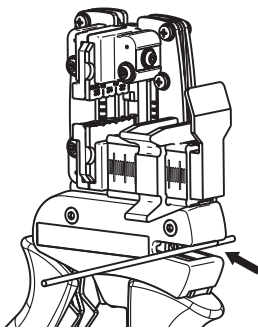
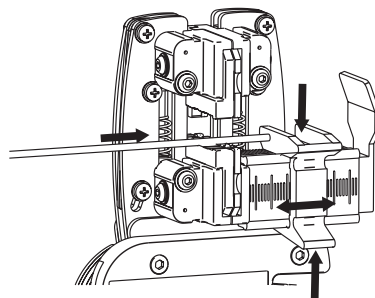
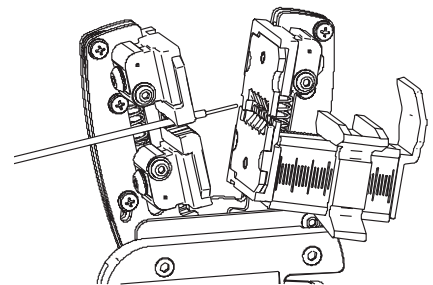
**Cutting****Positioning****Stripping****multi-stripax®****Technical data**

Cable type	PVC, Teflon, PTE, PUR, silicone, halogen free
Conductor cross-section, min.	2 mm
Conductor cross-section, max.	no limit (in several steps)
max. cutting capacity, fine-strand	6 mm <sup>2</sup>
max. cutting capacity, solid	2,5 mm <sup>2</sup>
max. cutting capacity, ribbon	10,2 x 4 mm
Length/Width/Height	250 / 85 / 40 mm
Weight	250 g
<b>Note</b>	



multi-stripax® incl. stripping unit

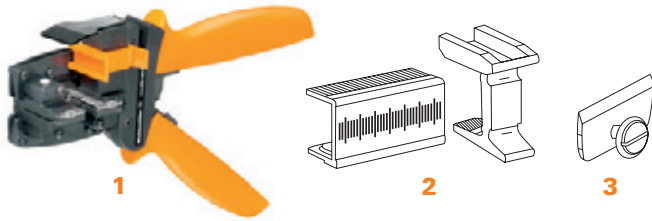

- High quality stripping for industrial applications
- Specially shaped stripping blades enable stripping of special types of insulation and conductor configurations
- Adjustable stop for setting stripping lengths from 2.3 to 30 mm
- Highly flexible thanks to interchangeable stripping units
- Stripping results reproduced accurately time and time again
- No damage to the conductor or insulation
- A durable, reliable tool thanks to its robust design
- Integral cutting function for max. 2.5 mm<sup>2</sup> solid or 6 mm<sup>2</sup> flexible cables

Ordering data

Illustration	Type	Qty.	Order No.	Features
1	multi-stripax® 0,25 -1,5S	1	9204540000	Halogen free PVC, silicone, teflon and Radox 3GK-insulated cables; Cable cross section 0.25 up to 1.5 mm <sup>2</sup> max. stripping lengths depends on cable design / cable type Cutting function up to 6 mm <sup>2</sup>
1	multi-stripax® 0,75 -4,0SL	1	9203610000	Halogen free PVC, silicone and teflon insulated cables; Cable cross section 0.75 up to 4 mm <sup>2</sup> max. stripping lengths depends on cable design / cable type Cutting function up to 6 mm <sup>2</sup>
1	multi-stripax® 1,5 -6,0S	1	9204560000	Halogen free PVC, silicone, teflon and Radox 3GKW-insulated cables; Cable cross section 1.5 up to 6 mm <sup>2</sup> max. stripping lengths depends on cable design / cable type Cutting function up to 6 mm <sup>2</sup>
1	multi-stripax® 16SL	1	9202220000	PVC insulated cables; Cable cross section 16 mm <sup>2</sup> max. stripping lengths depends on cable design / cable type 1. station solid, stranded and flexible (restricted) 2. station double stranded Cutting function up to 6 mm <sup>2</sup>
1	multi-stripax® 6-16	1	9202210000	PVC insulated cables; Cable cross section 6 up to 16 mm <sup>2</sup> ; max. stripping lengths depends on cable design / cable type 1. station solid, stranded and flexible 6 mm <sup>2</sup> 2. station solid, stranded and flexible 10 mm <sup>2</sup> 3. station solid, stranded and flexible 16 mm <sup>2</sup> double stranded (flexible) Cutting function up to 6 mm <sup>2</sup>
1	multi-stripax® AWG	1	9202230000	AWG with PTFE and PVC insulated cables; Cable cross-section AWG 26...16 max. stripping lengths depends on cable design Cutting function up to 6mm <sup>2</sup> (AWG 16)
1	multi-stripax® ASI	1	9202250000	ASI Bus cables 2 x 1.5 mm <sup>2</sup> flexible for PTE, PUR and EPDM insulated cables Stripping of outer insulation and inner cable Cutting function up to 6 mm <sup>2</sup>
1	multi-stripax® GKW LW	1	9205760000	Railway cable Radox GKW LW; Cable cross section 1.0; 1.5 and 2.5 mm <sup>2</sup> max. stripping lengths depends on cable design / cable type Cutting function up to 6 mm <sup>2</sup>
1	multi-stripax® PV	1	1190490000	Photovoltaics cable and comparable earth and short circuit proof cables; Cable cross section 2.5; 4 and 6 mm <sup>2</sup> max. stripping lengths depends on cable design / cable type Cutting function up to 6mm <sup>2</sup>
1	multi-stripax® POF	1	1208880000	Duplex Stripping tool for fast processing of POF fiber and cable according to IEC 60793-2 A4A fibre (1,000 µm/980 µm POF). Cutting function up to 6 mm <sup>2</sup>
2	ERAN multi-stripax®	1	9203100000	Length stop
3	ERME multi-stripax®	1	9203070000	Cutting knife

Note

Stripping and cutting tool multi-stripax®

Stripping unit consists of:

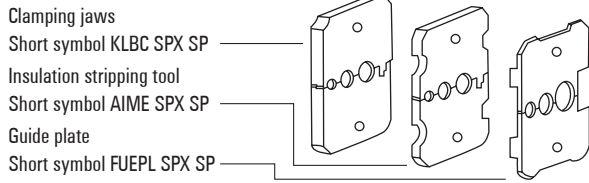

- Highly flexible thanks to interchangeable stripping units
- High quality stripping for industrial applications
- Specially shaped stripping blades enable stripping of special types of insulation and conductor configurations

Bestelldaten

Type	Qty.	Order No.	Features	
AIE multi-stripax® 0,25 -1,5S	1	9204550000	Halogen free PVC, silicone, teflon and Radox 3GK-insulated cables; Cable cross section 0.25 up to 1.5 mm <sup>2</sup> max. stripping lengths depends on cable design / cable type	
AIE multi-stripax® 0,75 -4,0SL	1	9203730000	Halogen free PVC, silicone and teflon insulated cables; Cable cross section 0.75 up to 4 mm <sup>2</sup> max. stripping lengths depends on cable design / cable type	
AIE multi-stripax® 1,5 -6,0S	1	9204570000	Halogen free PVC, silicone, teflon and Radox 3GKW-insulated cables; Cable cross section 1.5 up to 6 mm <sup>2</sup> max. stripping lengths depends on cable design / cable type	
AIE multi-stripax® 16SL	1	9202270000	PVC insulated cables; Cable cross section 16 mm <sup>2</sup> max. stripping lengths depends on cable design / cable type 1. station solid, stranded and flexible (restricted) 2. station double stranded	
AIE multi-stripax® 6-16	1	9202260000	PVC insulated cables; Cable cross section 6 up to 16 mm <sup>2</sup> ; max. stripping lengths depends on cable design / cable type 1. station solid, stranded and flexible 6 mm <sup>2</sup> 2. station solid, stranded and flexible 10 mm <sup>2</sup> 3. station solid, stranded and flexible 16 mm <sup>2</sup> double stranded (flexible)	
AIE multi-stripax® AWG	1	9202280000	AWG with PTFE and PVC-insulated cables; Cable cross section AWG 26...16 max. stripping lengths depends on cable design	
AIE multi-stripax® ASI	1	9202300000	ASI Bus cables 2 x 1.5 mm <sup>2</sup> flexible for PTE, PUR and EPDM insulated cables Stripping of outer insulation and inner cable	
AIE multi-stripax® GKW LW	1	9205770000	Railway cable Radox GKW LW; Cable cross section 1.0; 1.5 and 2.5 mm <sup>2</sup> max. stripping lengths depends on cable design / cable type	
AIE multi-stripax® PV	1	1204280000	Photovoltaics cable and comparable earth and short circuit proof cables; Cable cross section 2.5; 4 and 6 mm <sup>2</sup> max. stripping lengths depends on cable design / cable type	
AIE multi-stripax® POF	1	1212770000	Duplex Stripping tool for fast processing of POF fiber and cable according to IEC 60793-2 A4A fibre (1,000 µm/980 µm POF).	



Sheathing strippers

Sheathing strippers

- Sheathing stripper for round cables

AM 25 / AM 35

AM 25: Ø 6–25 mm; AM 35: Ø 25–36 mm



- Pivoting blade for circumferential, longitudinal and spiral cuts
- Retaining bracket with integrated blade to break open an incision in the insulation
- Integrated spare blade

AM 12

For UTP and STP data cables



- Cutting of UTP and STP data cables and other flexible copper cables with a diameter of up to 4 mm<sup>2</sup> (~AWG11)
- Stripping of the outer insulation of UTP and STP data cables and other round cables with Ø approx. 0.5 ... 12.5 mm
- No damage to the shielding or conductor due to adjustable stripping blade
- Length end stop for repeated cutting and stripping lengths



Technical data

Max. stripping performance	
Cable type	
Min. conductor diameter	mm
Depth of cut	
Cutting performance	
UTP und STP data cables, max. diameter	-
Copper cable - flexible, max.	-
Tool data	
Length	mm
Weight	g
Note	

AM 25	AM 35
PVC round cable	PVC round cable
6...25	25...36
adjustable up to 4.5 mm	adjustable up to 4.5 mm
Tool data	
Length	135
Weight	135
Note	

AM 12	
UTP and STP data cables	
0.5...12.5	
adjustable	
Tool data	
Length	97
Weight	36
Note	

Ordering data

Version	
Note	

Type	Qty.	Order No.
AM 25	1	9001540000
AM 35	1	9001080000
Note		

Type	Qty.	Order No.
AM 12	1	9030060000
Note		

Accessories

Note	

Type	Qty.	Order No.
ERSATZMESSER AM 25/35	2	9001530000
Sheathing stripper		
Note		

Type	Qty.	Order No.
Sheathing stripper		
Note		

### Sheathing strippers

- Sheathing strippers for insulated cables
- Especially suitable for stripping cables with PVC, PUR, PE, TPE and halogen-free LSZH insulation
- Insulation can be stripped from any point along the cable
- Opening of slit insulation with integrated cutter

#### AM 16

For round cables, Ø 5...17 mm



- Also highly suitable for stripping cables in the cable duct
- AM 16 guarantees precise cable routing
- Exact regulation of the cut depth with integrated visual display

#### AMF 6/10

For ribbon cable, 6 mm<sup>2</sup> and 10 mm<sup>2</sup>

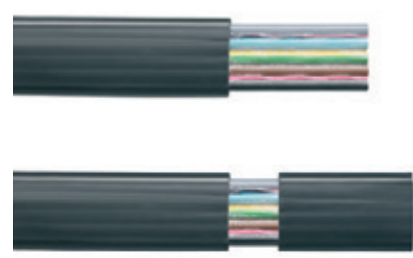
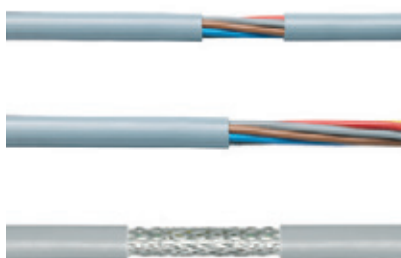

#### Technical data

Max. stripping performance	
Cable type	
Conductor cross-section, min. AWG	-
Min. conductor diameter	mm
Depth of cut	
Cutting performance	
UTP und STP data cables, max. diameter	-
Copper cable - flexible, max.	-
Tool data	
Length	mm
Weight	g
Note	

AM 16		
Round cable		
5...17		
0.5 - 2.5 mm <sup>2</sup>		

AMF 6/10		
PVC ribbon cable		
0 - 4.0 mm		

#### Ordering data

Version
Note

Type	Qty.	Order No.
AM 16	1	9204190000

Type	Qty.	Order No.
AMF 6/10	1	9204180000

#### Accessories

Note
------

Type	Qty.	Order No.
ERME AM 16	1	9204260000
Sheathing stripper		

Type	Qty.	Order No.
ERME AMF 6/10	1	9204250000
Sheathing stripper		

## Sheathing strippers

### Sheathing strippers for coaxial cable

- For coaxial cable and round (shielded) data cables from Ø 2.5...8 mm
- 1-, 2- and 3-level stripping in one step
- Fast changeover to other cable types thanks to adjustable and interchangeable screw holder
- Colour-coded, interchangeable cassettes with specified stripping length for standard coaxial cable: see table
- Setting block (included) permits quick pre-setting of cutting depths
- Blade cassettes can be used on both sides

### CST / IE-CST

Ø 2.5...8 mm



- RG 58 and RG 71
- RG 59 and RG 62
- Antenna cable
- Profibus cable
- Ethernet cable

### Cutter cassettes for CST



### Technical data

Max. stripping performance	
Cable type	
Min. conductor diameter	mm
Stripping length, max.	-
Tool data	
Length	mm
Weight	g
Note	

### Ordering data

Version
Note

### Accessories

Type	Qty.	Order No.
SCHA CST	1	9032060000
SCHRAUBENDREHER CST	1	9005720000
EINSTELLBLOCK CST	1	9005800000
Dimension A: as specified by connector manufacturer (not defined by tool)		
Note		

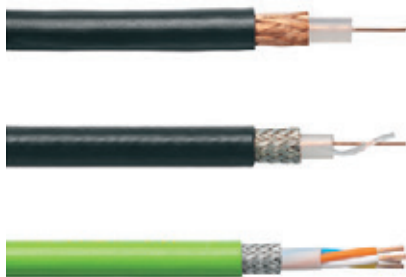

CST	IE-CST
Coaxial & round data cables	Coaxial & round data cables
2.5...8	2.5...8
100	100
65	85

Type	Qty.	Order No.
CST	1	9030500000
IE-CST	1	9204350000
IE-CST including blade cartridge, adjusted to Weidmüller Ethernet cable		

Type	Qty.	Order No.
SCHA CST	1	9032060000
SCHRAUBENDREHER CST	1	9005720000
EINSTELLBLOCK CST	1	9005800000
Dimension A: as specified by connector manufacturer (not defined by tool)		
Note		

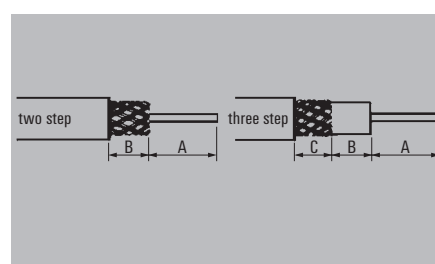

Colour cutter cassettes	B [mm]	C [mm]
grey	3.9	
red	6.0	
yellow	12.0	
blue	6.5	
white	8.6	
green	7.1	5.1
brown	7.5	3.5
orange	8.0	3.7
light green	6.0	6.0
black	8.6	2.3

Dim. A as stated by manufacturer (not defined by tool)

Colour cutter cassettes	Qty.	Order-No.
grey	1	9032050000
red	1	9032040000
yellow	1	9032030000
blue	1	9032020000
white	1	9204340000
green	1	9032000000
brown	1	9032010000
orange	1	9032200000
light green	1	9032210000
black	1	9032220000
Note		

### Sheathing strippers for coaxial cable

- For coaxial cable and round (shielded) data cables from Ø 2.5...8 mm
- 1-, 2- and 3-level stripping in one step
- Adjustable stripping lengths in 1 mm steps for meshwork and dielectric materials (min. stripping length approx. 3.2 mm)
- Fast changeover to other cable types
- Max. stripping length 17 mm
- Incl. 3 blades

### CST vario

Ø 2.5...8 mm



- RG 58 and RG 71
- RG 59 and RG 62
- Antenna cable
- Profibus cable
- Ethernet cable



### Technical data

Max. stripping performance	
Cable type	
Min. conductor diameter	mm
Stripping length, max.	mm
Tool data	
Length	mm
Weight	g
Note	

### Ordering data

Version
Note

### Accessories

Type	Qty.	Order No.
SCHRAUBENDREHER CST	1	9005720000
MESSERHALTER CST VARIO	1	9005740000
MESSEREINSATZ CST VARIO	1	9005730000
Includes spare blade set (1 set = 3 blades)		
Note		

CST VARIO		
Coaxial & round data cables		
Ø 2.5...8		
17		
116		
76		
Note		

Type	Qty.	Order No.
CST VARIO	1	9005700000
Note		

Type	Qty.	Order No.
SCHRAUBENDREHER CST	1	9005720000
MESSERHALTER CST VARIO	1	9005740000
MESSEREINSATZ CST VARIO	1	9005730000
Includes spare blade set (1 set = 3 blades)		
Note		

### CST Vario blade holder



### Ordering data

Type	Qty.	Order No.
CST VARIO BLADE HOLDER	1	9005740000

### CST Vario blade insert



### Ordering data

Type	Qty.	Order No.
CST VARIO BLADE INSERT	1	9005730000

### CST Screwdriver



### Ordering data

Type	Qty.	Order No.
CST SCREWDRIVER	1	9005720000

### Setting block CST



### Ordering data

Type	Qty.	Order No.
CST SETTING BLOCK	1	9005800000

### Screw holder CST



### Ordering data

Type	Qty.	Order No.
CST SCREW HOLDER	1	9032060000



## Sheathing strippers

### Cable sheathing stripper

- For fast and accurate stripping of cables for damp areas ranging from Ø 8 - 13 mm, e.g. NYM cable, 3 x 1.5 mm<sup>2</sup> to 5 x 2.5 mm<sup>2</sup>
- No need to set cutting depth
- Ideal for working in junction and distribution boxes

### Stripper round

#### Round cable stripper



- Damp-proof cable Ø 8...13 mm



### Stripper round top

#### Round cable stripper with individual wire stripper



- Damp-proof cable Ø 8...13 mm
- With stripping device for individual wires of 0.2-4.0 mm<sup>2</sup>
- With integrated longitudinal cutter
- Retractable internal blade



### Technical data

Max. stripping performance	
Cable type	
Min. conductor diameter	mm
Wire cross-section, min. / max.	-
Tool data	
Length	mm
Weight	g
Note	

### Ordering data

Version
Note

Stripper round		
Flexible and solid conductors with PVC insulation		
8...13		
125		
47		
Note		

Type	Qty.	Order No.
Stripper round	1	9918040000
Note		

STRIPPER ROUND TOP		
Flexible and solid conductors with PVC insulation		
8...13		
0.2...4		
125		
50		
Note		

Type	Qty.	Order No.
STRIPPER ROUND TOP	1	9918050000
Note		



**Cable knife**

- Simple, fast and accurate stripping of all conventional round cables from Ø 4...37 mm
- Circumferential and longitudinal cuts with automatic rotary blade
- Knurled screw at end of handle for setting cutting depth
- Spring-loaded cable retaining clip with thumb guard
- Spare blade in handle

**Slicer NO 16**

Cable cutter Ø 4...16 mm



- Operating range: 4...16 mm outer diameter



**Slicer NO 27**

Cable cutter Ø 8...28 mm



- Operating range: 8...28 mm outer diameter



**Technical data**

Max. stripping performance	
Cable type	
Min. conductor diameter	mm
Tool data	
Length	mm
Weight	g
Note	

SLICER NO 16		
Flexible and solid conductors with PVC insulation		
4...16		
122		
75		
Note		

SLICER NO 27		
Flexible and solid conductors with PVC insulation		
8...28		
122		
75		
Note		

**Ordering data**

Version	
Note	

Type	Qty.	Order No.
SLICER NO 16	1	9918070000
Note		

Type	Qty.	Order No.
SLICER NO 27	1	9918080000
Note		

**Accessories**

Note	
------	--

Type	Qty.	Order No.
ZUB SLICER NO16-35	2	9201430000
Note		

Type	Qty.	Order No.
ZUB SLICER NO16-35	2	9201430000
Note		

## Sheathing strippers

### Special cable sheathing stripper

Insulation stripping tool  
for data communication systems

### Stripper PC

Special cable stripper



### Stripper Coax

Special cable stripper



- Cable diameter Ø 5...15 mm
- For wires and conductors from 0.25 - 4.0 mm<sup>2</sup> (24 - 12 AWG)
- For data cables in the telecommunications and IT sectors
- IBM network cables
- Printer cables
- Control cables

- Cable diameter Ø 4.8...7.5 mm
- For PVC-insulated data communication and control cables
- RG 58 / RG 59
- TV antenna cables between Ø 4.8 and 7.5 mm
- PVC round cables 3 x 0.75 mm<sup>2</sup>



### Technical data

Max. stripping performance	
Cable type	
Min. conductor diameter	mm
Wire cross-section, min. / max.	mm <sup>2</sup>
Tool data	
Length	mm
Weight	g
Note	

### Ordering data

Version
Note

STRIPPER PC		
Data cable / telecommunications and IT		
Cable diameter	5...15	
Wire cross-section	0.25...4	
Length	125	
Weight	55	
Note		

Type	Qty.	Order No.
STRIPPER PC	1	9918060000
Note		

STRIPPER COAX		
Coaxial & round data cables		
Cable diameter	4.8...7.5	
Length	97	
Weight	22	
Note		

Type	Qty.	Order No.
STRIPPER COAX	1	9918030000
Note		

# Crimping

<b>Crimping</b>	Introduction	D.2
	Overview contacts – tools	D.4
	Crimping tools for wire end ferrules	D.6
	Introduction – Crimping tools for other contacts	D.14
	Crimping tools for other contacts	D.16
	Pressing tools	D.28
	Introduction / Mechanical and electro-hydraulic crimping tools	D.30
	Crimping tools PZ PK 6/70 and PZ RK 6/70	D.31
	Crimping tools PZ PK 10/120 and PZ RK 10/120	D.32
	Crimping tools MTR 35	D.33
	Crimping tools EPG 45 and MTR 110	D.35
	Crimping tools MTR 160 and MTR 300	D.39
	Crimping tools APG 55 and HPG 55	D.41
	Crimping tools APG 80 and HPG 80	D.44
	Battery-powered hydraulic cable cutter AKT 50	D.48
	Battery / Battery charger	D.49
	Insertion tool for twisted-pair cable	D.51
	Disconnect	D.52
	Tools for polymer optical fibre (POF)	D.54
	Cable tie tools	D.55

# Crimping

After stripping, appropriate contacts or wire end ferrules can be crimped to the cable end.

Crimping produces a reliable connection between conductor and contact, and has more or less completely replaced soldering.

Crimping describes the production of a uniform, non-detachable connection between conductor and connecting element.

This should be achieved exclusively by the use of a high-quality precision tool. The result is a safe, reliable connection in both electrical and mechanical terms.

Weidmüller offers a wide range of mechanical crimping tools. An integral ratchet mechanism with disengage option guarantees optimum processing quality. Crimp connections produced with Weidmüller tools comply with international standards and specifications.

The DIN EN 60352-2 standard recommends that tools and contacts should come from the same manufacturer, since this is the only way to ensure consistently high quality. Otherwise, it is the user who is responsible for the quality. Weidmüller tools are designed to fit with Weidmüller contacts and thus are in full compliance with the DIN EN standard.

**Note:** The AWG cross-section specifications can be compared with the equivalent metric specifications.

## Crimping of wire end ferrule: an example of an optimum crimp of different cross-sections.

A crimp connection using manual and automatic Weidmüller tools can be seen below. The conductor insulation must be pushed into the plastic collar and the ferrule sleeve must be completely filled by the conductor. Depending on the cross-section, the conductor should protrude approx. 0 ... 0.5 mm from the ferrule sleeve.

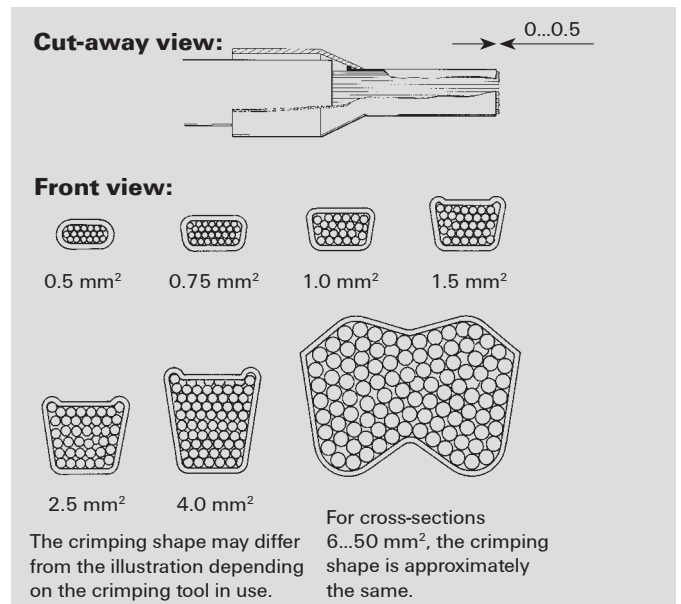

### Faulty crimping connections due to an incorrect combination of cable and wire end ferrule

It is not possible for a tool to function reliably with every combination of conductor and crimping material. It is possible that the standard requirements for the crimped product can't be achieved, although taken on their own, both conductor and crimping material comply with the corresponding standard. The individual production tolerances of conductor and crimping material do not allow every conductor to be combined with every contact.

The combination of conductors, crimping material and crimping tool must be coordinated: this procedure is all the more difficult given the large number of products on the market.

This means that the material must be defined and the crimping result tested, ensuring that the test, and later on the tool, satisfy the same conditions.

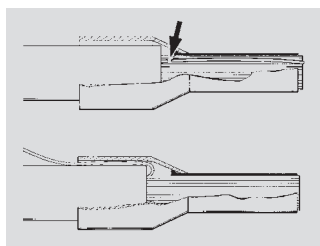

**Single conductor squeezed off**

**Single conductor pushed back**

### Faults which can occur during crimping:

- Cracks along the sides and die impressions
- Splitting of the ferrules
- Asymmetrical crimping shape
- Extreme burrs formed along the sides
- Ferrule not filled by the conductor
- Single conductors pushed back protruding from the collar
- Single conductors squeezed off
- Plastic collar damaged by the crimping jaw
- Conductor insulation not pushed into the plastic collar
- Ferrule bent longitudinally after crimping

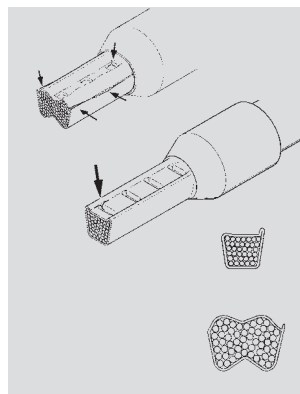

Formation of cracks at the sides.  
Sides split open

Formation of cracks at the impressions  
of the crimping jaw

Asymmetrical crimping shape  
Burr formation on one side

Asymmetrical crimping shape  
Burr formation on one side

#### Note:

The ferrule must not split open after it has been connected once in any Weidmüller terminal corresponding to the conductor cross-section (with a torque according to IEC 60947-1)











Overview contacts – tools

Crimping

D

Crimp contact	Crimp type	Description	Conductor crosssection in mm <sup>2</sup>	AWG	Crimping tool	Order No. tool	page
Wire end ferrules		with plastic collar	0,5...2,5	20...14	Stripax Plus 2.5	9020000000	D.6
		with / without plastic collar	0,14...6	26...10	PZ 6 roto	9014350000	D.9
			0,14...1,5	24...16	PZ 1.5	9005990000	D.7
			0,5...4	20...12	PZ 4	9012500000	D.8
		with / without plastic collar	0,14...6	26...8	PZ 10 HEX	1445070000	D.10
				with / without plastic collar	0,25...6	24...10	PZ 6/5
		with / without plastic collar			0,5...6	20...10	PZ 3
			26...8	PZ 10 SQR	1445080000	D.10	
		with / without plastic collar	6...16	10...6	PZ 16	9012600000	D.11
			25...50	3...1	PZ 50	9006450000	D.12
Twin wire end ferrules		Twin wire end ferrules	0,5...1	20...17	PZ 1.5	9005990000	D.7
			0,5...4	20...10	PZ 10 HEX	1445070000	D.10
			0,5...2,5	20...14	PZ 4	9012500000	D.8
			0,5...4	20...12	PZ 6/5	9011460000	D.8
			0,5...4	20...12	PZ 3	0567300000	D.7
			0,5...4	20...12	PZ 6 roto	9014350000	D.9
			6...16	10...6	PZ ZH 16	9013600000	D.11
Stamped contacts		Weidmüller DFF series	0,22...2,5	24...12	HTF DFF	9014140000	D.27
		Weidmüller ZRV and MKF series	0,2...0,35 / 0,5...1	24...22 / 20...17	HTF ZRV	9014840000	D.27
		Weidmüller FEKO ZRV series	0,2...2,5	24...12	HTF AFK 2.5	9201040000	D.27
		Weidmüller RSV and DSTV-HD Systems	0,14...1,5	26...16	HTF RSV 16	9013560000	D.27
			2,5	14...12	HTF RSV 12	9013550000	D.27
Turned contacts		Turned HD and HE contacts	4...10	12...7	CTX CM 3,6	9018480000	D.20
			0,14...4	26...12	CTX CM 1,6/2,5	9018490000	D.20
		Turned HD, HE and HX contacts	0,14...6	26...10	CTIN CM 1,6/2,5	9205430000	D.20
			1,5...10	16...7	CTIN CM 3,6	9205440000	D.20



Crimp contact	Crimp type	Description	Conductor crossection in mm <sup>2</sup>	AWG	Crimping tool	Order No. tool	page	
coaxial connectors		coaxial connectors			HTG 58	9012000000	D.25	
					HTG 58/59	9012020000	D.25	
					HTG 59	9012010000	D.25	
					HTG 174	9012410000	D.25	
					HTX 138	9012400000	D.25	
					HTX 188	9011990000	D.25	
coaxial connectors		coaxial connectors			CTX 500	9006320000	D.26	
					CTX 501	9006370000	D.26	
					CTX 502	9006380000	D.26	
insulated / non-insulated connectors		insulated connectors	0,5...2,5	20...14	HTI 15	9014400000	D.18	
			0,5...6	20...10	CTI 6	9006120000	D.17	
			0,5...6	20...10	CTI 6 G	9202850000	D.17	
		non-insulated connectors	0,5...6	20...10	HTN 21	9014610000	D.18	
			0,5...6	20...10	HTN 21 with end stop	9014100000	D.18	
			10...25	7...3	CTN 25 D4	9006220000	D.19	
10...25	7...3	CTN 25 D5	9006230000	D.19				
modular plug connectors		WE-plug (4, 6 and 8-poles)	0,08...0,25	28...24	TT 864 RS WE	9008120000	D.29	
		WE-plug (4, 6 and 10-poles)	0,08...0,25	28...24	TT 1064 RS WE	9008190000	D.29	
		shielded WE-plug, system Hirose	0,08...0,25	28...24	TT8 RS MP8	9202800000	D.28	
Other contacts and plugs		SUB-D contacts	0,08...0,5	28...20	HTF SUB-D	9013260000	D.26	
		flat blade connectors and receptacles	0,1...1 (connec. width 2,8)	27...17	HTF 28	9013090000	D.16	
			0,5...2,5 (connec. width 4,8)	20...14	HTF 48	9013080000	D.16	
			0,5...2,5 (connec. width 6,3)	20...14	HTF 63	9013400000	D.16	
			0,5...6 (connec. width 6,3)	20...10	CTF 63	9202860000	D.16	
		fibre optic connectors	Station 1 (hexagon crimp): 3,15 / 6,0 H.- → 3,9			HTX LWL	9011360000	D.21
			Station 2 (round crimp): 4,85 / 6,0 H.- → 5,5			HTX LWL	9011360000	D.21
		IP 67 connector				IE-CT-SC-GOF	9205320000	D.22
						IE-CT-LC-GOF	9205330000	D.22
					IE-CT-SC-POF	9205340000	D.22	
					IE-CT-SC-GOF-P	9205350000	D.22	

Crimping

D



## Crimping tools for wire end ferrules

### Crimping tools for wire end ferrules

- 3 functions: cutting, stripping, crimping
- Wire-end ferrules with plastic collars, in compliance with DIN 46228 Part 4
- Ratchet for precise crimping
- Efficient operation: laborious change of tools not necessary, resulting in significant time savings
- Automatic conveyance of wire-end ferrules
- Quick adjustment for different cross-sections
- Easy handling of ferrule strips

Only strips of linked wire-end ferrules, each containing 50 pieces, from Weidmüller may be processed. The use of wire-end ferrules on reels may lead to destruction.

### stripax® plus 2.5

0.5...2.5 mm<sup>2</sup>



- ~AWG 20...14
- Processing of strips from linked wire-end ferrules of 0.5...2.5 mm<sup>2</sup> from Weidmüller



### Technical data

Description of contact	
Type of contact	
Crimping range	mm <sup>2</sup>
Crimping range 1 (with multiple crimping positions)	mm <sup>2</sup>
Crimping range 2 (with multiple crimping positions)	mm <sup>2</sup>
Crimping range 3 (with multiple crimping positions)	mm <sup>2</sup>
Crimping range 4 (with multiple crimping positions)	-
Crimping range 5 (with multiple crimping positions)	-
Tool data	
Length	mm
Weight	g
Note	

### Ordering data

Version
Note

### Accessories

Note

stripax® plus 2.5	
Strips of linked wire-end ferrules	
Crimping range	mm <sup>2</sup>
Crimping range 1 (with multiple crimping positions)	mm <sup>2</sup>
Crimping range 2 (with multiple crimping positions)	mm <sup>2</sup>
Crimping range 3 (with multiple crimping positions)	mm <sup>2</sup>
Crimping range 4 (with multiple crimping positions)	-
Crimping range 5 (with multiple crimping positions)	-
Tool data	
Length	mm
Weight	g
Note	
Only strip-type products from Weidmüller may be processed. The use of wire-end ferrules on reels may lead to destruction.	

Type	Qty.	Order No.
STRIPAX PLUS 2.5	1	9020000000
STRIPAX PLUS 2.5 ZERT	1	9011980000
Additional accessories can be found in chapter J		

Type	Qty.	Order No.
ERSATZMESSER STRIPAX PL	5	9050340000

### Crimping tools for wire end ferrules

- For wire-end ferrules with and without plastic collars, according to DIN 46228 Part 1 and Part 4
- Ratchet for precise crimping
- Release option in the event of incorrect operation

#### PZ 1.5

0.14...1.5 mm<sup>2</sup>



- ~AWG 26...16
- Only one die for the whole cross-section range
- Crimp complies with Euro-Norm EN 60947-1
- Wire-end ferrule insertion from the front



#### PZ 3

0.5...6 mm<sup>2</sup>



- ~AWG 21...10
- Only one die for the whole cross-section range
- Wire-end ferrule insertion from the front



### Technical data

Description of contact	
Type of contact	
Crimping range	mm <sup>2</sup>
Crimping range 1 (with multiple crimping positions)	-
Crimping range 2 (with multiple crimping positions)	-
Crimping range 3 (with multiple crimping positions)	-
Crimping range 4 (with multiple crimping positions)	-
Crimping range 5 (with multiple crimping positions)	-
Tool data	
Length	mm
Weight	g
Note	

### Ordering data

Version
Note

PZ 1.5		
Wire-end ferrules with/without plastic collars		
Crimping range	0.14...1.5	
Crimping range 1 (with multiple crimping positions)	-	
Crimping range 2 (with multiple crimping positions)	-	
Crimping range 3 (with multiple crimping positions)	-	
Crimping range 4 (with multiple crimping positions)	-	
Crimping range 5 (with multiple crimping positions)	-	
Tool data		
Length	170	
Weight	170	
Note		

Type	Qty.	Order No.
PZ 1.5	1	9005990000
PZ 1.5 ZERT	1	9017310000
Additional accessories can be found in Chapter J		

PZ 3		
Wire-end ferrules with/without plastic collars		
Crimping range	0.5...6	
Crimping range 1 (with multiple crimping positions)	-	
Crimping range 2 (with multiple crimping positions)	-	
Crimping range 3 (with multiple crimping positions)	-	
Crimping range 4 (with multiple crimping positions)	-	
Crimping range 5 (with multiple crimping positions)	-	
Tool data		
Length	200	
Weight	426	
Note		

Type	Qty.	Order No.
PZ 3	1	0567300000
PZ 3 ZERT	1	9017360000
Additional accessories can be found in Chapter J		

## Crimping tools for wire end ferrules

## Crimping tools for wire end ferrules

- For wire-end ferrules with and without plastic collars, according to DIN 46228 T.1 and T.4
- Ratchet for precise crimping
- Release option in the event of incorrect operation

## PZ 4

0.5...4 mm<sup>2</sup>

- ~AWG 21...12
- Only one crimping station for the whole cross-section range
- Wire-end ferrule insertion from the side



## PZ 6/5

0.25...6 mm<sup>2</sup>

- ~AWG 24...10
- Crimp complies with Euro-Norm EN 60947-1
- Approval according to VG 95211 (military designation VG 95 236 T 14 B 002)
- Five crimping stations corresponding to the conductor cross-sections
- Wire-end ferrule insertion from the side



## Technical data

Description of contact	
Type of contact	
Crimping range	mm <sup>2</sup>
Crimping range 1 (with multiple crimping positions)	-
Crimping range 2 (with multiple crimping positions)	-
Crimping range 3 (with multiple crimping positions)	-
Crimping range 4 (with multiple crimping positions)	-
Crimping range 5 (with multiple crimping positions)	-
Tool data	
Length	mm
Weight	g
Note	

## Ordering data

Version
Note

PZ 4		
Wire-end ferrules with/without plastic collars		
Crimping range		mm <sup>2</sup>
Crimping range 1 (with multiple crimping positions)		-
Crimping range 2 (with multiple crimping positions)		-
Crimping range 3 (with multiple crimping positions)		-
Crimping range 4 (with multiple crimping positions)		-
Crimping range 5 (with multiple crimping positions)		-
Tool data		
Length		mm
Weight		g
Note		

Type	Qty.	Order No.
PZ 4	1	9012500000
PZ 4 ZERT	1	9017300000
Additional accessories can be found in Chapter J		

PZ 6/5		
Wire-end ferrules with/without plastic collars		
Crimping range		mm <sup>2</sup>
Crimping range 1 (with multiple crimping positions)		-
Crimping range 2 (with multiple crimping positions)		-
Crimping range 3 (with multiple crimping positions)		-
Crimping range 4 (with multiple crimping positions)		-
Crimping range 5 (with multiple crimping positions)		-
Tool data		
Length		mm
Weight		g
Note		

Type	Qty.	Order No.
PZ 6/5	1	9011460000
PZ 6/5 ZERT	1	9017900000
Additional accessories can be found in Chapter J		

### Crimping tools for wire end ferrules

- For wire-end ferrules with and without plastic collars in accordance with DIN 46228 Part 1 and Part 4
- Rotating crimp insert, lockable
- Insert the wire-end ferrules from the side or front
- Ratchet for precise crimping
- Release option if misused

#### PZ 6 Roto L

0.14–6 mm<sup>2</sup>

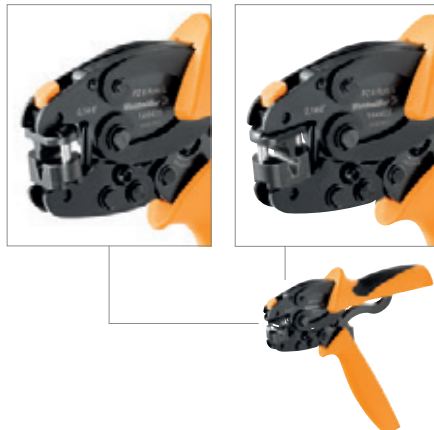

- ~AWG 26...10
- Only one crimp insert for the whole cross-section range
- A rotating crimp insert allows for wire-end ferrules to be inserted from the side or front
- Lockable die



#### PZ 6 Roto

0.14...6 mm<sup>2</sup>



- ~AWG 26...10
- Only one die for the whole cross-section range
- Rotating die enables wire-end ferrule insertion from the front or side



### Technical data

Description of contact	
Type of contact	
Crimping range	mm <sup>2</sup>
Crimping range 1 (with multiple crimping positions)	-
Crimping range 2 (with multiple crimping positions)	-
Crimping range 3 (with multiple crimping positions)	-
Crimping range 4 (with multiple crimping positions)	-
Crimping range 5 (with multiple crimping positions)	-
Tool data	
Length	mm
Weight	g
Note	

### Ordering data

Version
Note

PZ 6 roto L		
Wire-end ferrules with/without plastic collars		
Crimping range	0.14...6	
Crimping range 1 (with multiple crimping positions)	-	
Crimping range 2 (with multiple crimping positions)	-	
Crimping range 3 (with multiple crimping positions)	-	
Crimping range 4 (with multiple crimping positions)	-	
Crimping range 5 (with multiple crimping positions)	-	
Tool data		
Length	200	
Weight	428	
Note		

Type	Qty.	Order No.
PZ 6 ROTO L	1	1444050000
PZ 6 ROTO L ZERT	1	1527230000
Additional accessories can be found in Chapter J		

PZ 6 roto		
Wire-end ferrules with/without plastic collars		
Crimping range	0.14...6	
Crimping range 1 (with multiple crimping positions)	-	
Crimping range 2 (with multiple crimping positions)	-	
Crimping range 3 (with multiple crimping positions)	-	
Crimping range 4 (with multiple crimping positions)	-	
Crimping range 5 (with multiple crimping positions)	-	
Tool data		
Length	200	
Weight	428	
Note		

Type	Qty.	Order No.
PZ 6 Roto	1	9014350000
PZ 6 ROTO ZERT	1	9017440000
Additional accessories can be found in Chapter J		

**PZ 10 HEX**

0.14 ... 10 mm<sup>2</sup>



- ~AWG 26 ... 8
- Only one die for the whole cross-section range of 0.14 ... 10 mm<sup>2</sup>
- Side wire-end ferrule insertion with hexagon crimp shape



**PZ 10 SQR**

0.14 ... 10 mm<sup>2</sup>



- ~AWG 26 ... 8
- Only one die for the whole cross-section range of 0.14 ... 10 mm<sup>2</sup>
- Side wire-end ferrule insertion with square crimp shape

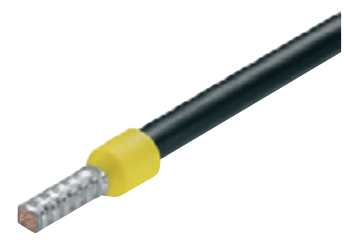

**Technical data**

Description of contact	
Type of contact	
Crimping range	mm <sup>2</sup>
Crimping range 1 (with multiple crimping positions)	-
Crimping range 2 (with multiple crimping positions)	-
Crimping range 3 (with multiple crimping positions)	-
Crimping range 4 (with multiple crimping positions)	-
Crimping range 5 (with multiple crimping positions)	-
Tool data	
Length	mm
Weight	g
Note	

Wire-end ferrules with/without plastic collars		
Crimping range		0.14...10
Crimping range 1 (with multiple crimping positions)		
Crimping range 2 (with multiple crimping positions)		
Crimping range 3 (with multiple crimping positions)		
Crimping range 4 (with multiple crimping positions)		
Crimping range 5 (with multiple crimping positions)		
Length		195
Weight		600
Note		

Wire-end ferrules with/without plastic collars		
Crimping range		0.14...10
Crimping range 1 (with multiple crimping positions)		
Crimping range 2 (with multiple crimping positions)		
Crimping range 3 (with multiple crimping positions)		
Crimping range 4 (with multiple crimping positions)		
Crimping range 5 (with multiple crimping positions)		
Length		195
Weight		600
Note		

**Ordering data**

Version
Note

Type	Qty.	Order No.
PZ 10 HEX	1	1445070000
PZ 10 HEX ZERT	1	1989320000

Type	Qty.	Order No.
PZ 10 SQR	1	1445080000
PZ 10 SQR ZERT	1	1989310000

### Crimping tools for wire end ferrules

- For wire-end ferrules with and without plastic collars, according to DIN 46228 Part 1 and Part 4
- Ratchet for precise crimping
- Release option in the event of incorrect operation

#### PZ 16

6...16 mm<sup>2</sup>



- ~AWG 10...6
- Crimp complies with Euro-Norm EN 60947-1
- Approval according to VG 95211 (military designation VG 95 236 T 14 B 002)
- Three crimping stations corresponding to the conductor cross-sections
- Wire-end ferrule insertion from the side



#### PZ ZH 16

Twin wire-end ferrules from 6...16 mm<sup>2</sup>



- ~ AWG 10...6
- Three crimping stations corresponding to the conductor cross-sections
- Wire-end ferrule insertion from the side



### Technical data

Description of contact	
Type of contact	
Crimping range	mm <sup>2</sup>
Crimping range 1 (with multiple crimping positions)	mm <sup>2</sup>
Crimping range 2 (with multiple crimping positions)	mm <sup>2</sup>
Crimping range 3 (with multiple crimping positions)	mm <sup>2</sup>
Crimping range 4 (with multiple crimping positions)	-
Crimping range 5 (with multiple crimping positions)	-
Tool data	
Length	mm
Weight	g
Note	

### Ordering data

Version
Note

PZ 16		
Wire-end ferrules with/without plastic collars		
Crimping range	6...16	
Crimping range 1	6	
Crimping range 2	10	
Crimping range 3	16	
Crimping range 4	-	
Crimping range 5	-	
Length	200	
Weight	418	
Note		

Type	Qty.	Order No.
PZ 16	1	9012600000
PZ 16 ZERT	1	9017340000
Additional accessories can be found in Chapter J		

PZ ZH 16		
Twin wire-end ferrules		
Crimping range	6...16	
Crimping range 1	6	
Crimping range 2	10	
Crimping range 3	16	
Crimping range 4	-	
Crimping range 5	-	
Length	250	
Weight	730	
Note		

Type	Qty.	Order No.
PZ ZH 16	1	9013600000
PZ ZH 16 ZERT	1	9013610000
Additional accessories can be found in Chapter J		

## Crimping tools for wire end ferrules

## Crimping tools for wire end ferrules

- For wire-end ferrules with and without plastic collars, according to DIN 46228 T.1 and T.4
- Ratchet for precise crimping
- Release option in the event of incorrect operation

## PZ 50

25...50 mm<sup>2</sup>

- ~AWG 4...0
- Crimp complies with Euro-Norm EN 60947-1
- Approval according to VG 95211 (military designation VG 95 236 T 14 B 002)
- Three crimping stations corresponding to the conductor cross-sections
- Wire-end ferrule insertion from the side



## Technical data

Description of contact	
Type of contact	
Crimping range	mm <sup>2</sup>
Crimping range 1 (with multiple crimping positions)	mm <sup>2</sup>
Crimping range 2 (with multiple crimping positions)	mm <sup>2</sup>
Crimping range 3 (with multiple crimping positions)	mm <sup>2</sup>
Crimping range 4 (with multiple crimping positions)	-
Crimping range 5 (with multiple crimping positions)	-
Tool data	
Length	mm
Weight	g
Note	

## Ordering data

Version
Note

PZ 50	
Wire-end ferrules with/without plastic collars	
Crimping range	25...50
Crimping range 1	25
Crimping range 2	35
Crimping range 3	50
Crimping range 4	-
Crimping range 5	-
Length	250
Weight	730
Note	

Type	Qty.	Order No.
PZ 50	1	9006450000
PZ 50 ZERT	1	9017400000
Additional accessories can be found in Chapter J		





## Crimping tool for custom contacts

The crimping technique is one of the most reliable and most versatile connection methods. Extreme quality demands for a variety of different connections require that you use a wide variety of specialised crimping tools which are designed for specific contacts.

Weidmüller offers the right crimping tool for a wide variety of contact, regardless of whether you are using turned contacts, cable-lug connectors, insulated connectors or coaxial connectors.





## Crimping tools for other contacts

## Crimping tools for other contacts

- Ratchet for precise crimping
- Release option in the event of incorrect operation
- With end stop for exact positioning of the contacts
- Contact and insulation are crimped in one step

## HTF 28 / HTF 48 / HTF 63

0.1...2.5 mm<sup>2</sup>

For flat-blade connectors and flat-blade receptacles with pre-rolled crimp claw

## HTF 28

- ~AWG 28...18
- Plug width 2.8 mm, from 0.1...1.0 mm<sup>2</sup>

## HTF 48

- ~AWG 21...14
- Plug width 4.8 mm, from 0.5...2.5 mm<sup>2</sup>

## HTF 63

- ~AWG 21...14
- Plug width 6.3 mm, from 0.5...2.5 mm<sup>2</sup>



## CTF 63

0.5...6 mm<sup>2</sup>

For flat-blade connectors and flat-blade receptacles with pre-rolled crimp claw

## CTF 63

- ~AWG 21...10
- Plug width 6.3 mm, from 0.5...6 mm<sup>2</sup>



## Technical data

Description of contact	
Type of contact	
Crimping range	mm <sup>2</sup>
Crimping range 1 (with multiple crimping positions)	mm <sup>2</sup>
Crimping range 2 (with multiple crimping positions)	mm <sup>2</sup>
Crimping range 3 (with multiple crimping positions)	mm <sup>2</sup>
Plug width	mm
Tool data	
Length	mm
Weight	g
Note	

## Ordering data

Version
Note

	HTF 28	HTF 48	HTF 63
Type	F-plug / -sleeve	F-plug / -sleeve	F-plug / -sleeve
Crimping range	0.1...1	0.5...2.5	0.5...2.5
Crimping range 1 (with multiple crimping positions)	0.1...0.25	0.5...1	0.5...1
Crimping range 2 (with multiple crimping positions)	0.25...0.5	1.5...2.5	1.5...2.5
Crimping range 3 (with multiple crimping positions)	0.6...1		
Plug width	2.8	4.8	6.3
Length	200	200	200
Weight	438	438	438
Note			

Type	Qty.	Order No.
HTF 28	1	9013090000
HTF 28 ZERT	1	9017410000
HTF 48	1	9013080000
HTF 48 ZERT	1	9017260000
HTF 63	1	9013400000
HTF 63 ZERT	1	9017240000
Note	Additional accessories can be found in Chapter J	

	CTF 63
Type	F-plug / -sleeve
Crimping range	0.5...6
Crimping range 1 (with multiple crimping positions)	0.5...1
Crimping range 2 (with multiple crimping positions)	1.5...2.5
Crimping range 3 (with multiple crimping positions)	2.6...6
Plug width	6.3
Length	250
Weight	730
Note	

Type	Qty.	Order No.
CTF 63	1	9202860000
CTF 63 ZERT	1	1077010000
Note	Additional accessories can be found in Chapter J	



**Crimping tools for other contacts**

- Ratchet for precise crimping
- Release option in the event of incorrect operation
- With end stop for exact positioning of the contacts

**CTI 6 G**

0,5...6 mm<sup>2</sup>



For PVC-, PC- and polyamide-insulated connectors

- ~AWG 21...10
- Parallel crimp profile for crimping contact and insulation in one step



**CTI 6**

0,5...6 mm<sup>2</sup>



For PVC-, PC- and polyamide-insulated connectors

- ~AWG 21...10
- Double-crimp profile for crimping contact and insulation in one step



**Technical data**

Description of contact	
Type of contact	
Crimping range	mm <sup>2</sup>
Crimping range 1 (with multiple crimping positions)	mm <sup>2</sup>
Crimping range 2 (with multiple crimping positions)	mm <sup>2</sup>
Crimping range 3 (with multiple crimping positions)	mm <sup>2</sup>
Plug width	-
Tool data	
Length	mm
Weight	g
Note	

**Ordering data**

Version
Note

CTI 6 G		
Insulated connector		
Crimping range	mm <sup>2</sup>	0.5...6
Crimping range 1 (with multiple crimping positions)	mm <sup>2</sup>	0.5...1.5
Crimping range 2 (with multiple crimping positions)	mm <sup>2</sup>	1.1...2.5
Crimping range 3 (with multiple crimping positions)	mm <sup>2</sup>	2.6...6
Plug width		
Tool data		
Length	mm	250
Weight	g	747
Note		

Type	Qty.	Order No.
CTI 6 G	1	9202850000
CTI 6 G ZERT	1	1292880000
Additional accessories can be found in Chapter J		

CTI 6		
Insulated connector		
Crimping range	mm <sup>2</sup>	0.5...6
Crimping range 1 (with multiple crimping positions)	mm <sup>2</sup>	0.5...1.5
Crimping range 2 (with multiple crimping positions)	mm <sup>2</sup>	1.1...2.5
Crimping range 3 (with multiple crimping positions)	mm <sup>2</sup>	2.6...6
Plug width		
Tool data		
Length	mm	250
Weight	g	730
Note		

Type	Qty.	Order No.
CTI 6	1	9006120000
CTI 6 ZERT	1	9017290000
Additional accessories can be found in Chapter J		

Crimping tools for other contacts

Crimping tools for other contacts

- Ratchet for precise crimping
- Release option in the event of incorrect operation
- With end stop for exact positioning of the contacts
- Tested according to DIN EN 60352 Part 2

HTI 15

0.5...2.5 mm<sup>2</sup>



For PVC-, PC- and polyamide-insulated connectors

- ~AWG 21...14
- Double-crimp profile, for crimping contact and insulation in one step



HTN 21

0.5...6 mm<sup>2</sup>



For uninsulated cable lugs and connectors

- ~AWG 21...10
- Rolled cable lugs, for example acc. to DIN 46234
- Tubular cable lugs
- Pin cable lugs
- Parallel and serial connectors
- Indent crimping
- Alternatively available with or without pivoting end stop



Technical data

Description of contact	
Type of contact	
Crimping range	mm <sup>2</sup>
Crimping range 1 (with multiple crimping positions)	mm <sup>2</sup>
Crimping range 2 (with multiple crimping positions)	mm <sup>2</sup>
Crimping range 3 (with multiple crimping positions)	-
Plug width	-
Tool data	
Length	mm
Weight	g
Note	

Ordering data

Version
Note

HTI 15		
Insulated connector		
Crimping range	mm <sup>2</sup>	0.5...2.5
Crimping range 1 (with multiple crimping positions)	mm <sup>2</sup>	0.5...1.5
Crimping range 2 (with multiple crimping positions)	mm <sup>2</sup>	1.1...2.5
Crimping range 3 (with multiple crimping positions)	-	
Plug width	-	
Tool data		
Length	mm	200
Weight	g	434
Note		

Type	Qty.	Order No.
HTI 15	1	9014400000
HTI 15 ZERT	1	9017430000
Note		
Additional accessories can be found in Chapter J		

HTN 21		HTN 21 M. AN.	
Uninsulated connection		Uninsulated connection	
Crimping range	mm <sup>2</sup>	0.5...6	0.5...6
Crimping range 1 (with multiple crimping positions)	mm <sup>2</sup>	0.5...1.5	0.5...1.5
Crimping range 2 (with multiple crimping positions)	mm <sup>2</sup>	1.1...2.5	1.1...2.5
Crimping range 3 (with multiple crimping positions)	-	2.6...6	2.6...6
Plug width	-		
Tool data			
Length	mm	200	200
Weight	g	427	427
Note			
Without locator			

Type	Qty.	Order No.
HTN 21	1	9014610000
HTN 21 ZERT	1	9017380000
HTN 21 M. AN	1	9014100000
HTN 21 M. AN ZERT	1	9017170000
Note		

### Crimping tools for other contacts

- Ratchet for precise crimping
- Release option in the event of incorrect operation

#### CTN 25 D 4

10...25 mm<sup>2</sup>

For uninsulated cable lugs and connectors

- ~AWG 8...4
- Rolled cable lugs, acc. to DIN 46234
- Pin cable lugs
- Parallel and serial connectors
- Indent crimping



#### CTN 25 D 5

10...25 mm<sup>2</sup>

For uninsulated cable lugs and connectors

- ~AWG 8...4
- Rolled cable lugs, acc. to DIN 46234
- Pin cable lugs
- Parallel and serial connectors
- Hexagon crimping



### Technical data

Description of contact	
Type of contact	
Crimping range	mm <sup>2</sup>
Crimping range 1 (with multiple crimping positions)	mm <sup>2</sup>
Crimping range 2 (with multiple crimping positions)	mm <sup>2</sup>
Crimping range 3 (with multiple crimping positions)	mm <sup>2</sup>
Plug width	-
Tool data	
Length	mm
Weight	g
Note	

### Ordering data

Version
Note

CTN 25 D4		
Uninsulated connection		
Crimping range		10...25
Crimping range 1 (with multiple crimping positions)		10
Crimping range 2 (with multiple crimping positions)		16
Crimping range 3 (with multiple crimping positions)		25
Length		250
Weight		730
Note		

Type	Qty.	Order No.
CTN 25 D4	1	9006220000
CTN 25 D4 ZERT	1	9017350000
Additional accessories can be found in Chapter J		

CTN 25 D5		
Uninsulated connection		
Crimping range		10...25
Crimping range 1 (with multiple crimping positions)		10
Crimping range 2 (with multiple crimping positions)		16
Crimping range 3 (with multiple crimping positions)		25
Length		250
Weight		730
Note		

Type	Qty.	Order No.
CTN 25 D5	1	9006230000
CTN 25 D5 ZERT	1	1292870000
Additional accessories can be found in Chapter J		



Crimping tools for other contacts

Crimping tools for other contacts

- Ratchet for precise crimping
- Release option in the event of incorrect operation
- With end stop for exact positioning of the contacts

CTX CM 1.6/2.5 / CTX CM 3.6

0.14...10 mm<sup>2</sup>



CTX CM 1.6/2.5

- Turned HD contacts
- Turned HE contacts
- ConCept M10 and M5 contacts
- ~AWG 26...12
- 0.14...4.0 mm<sup>2</sup>

CTX CM 3.6

- Turned HD contacts
- ConCept M3 contacts
- ~AWG 12...8
- 4.0...10 mm<sup>2</sup>

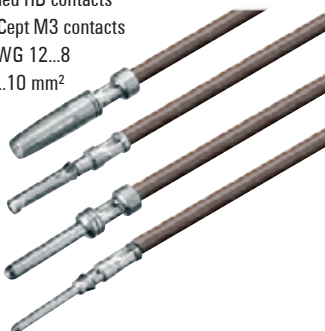

CTIN CM 1.6/2.5 / CTIN 3.6

0.14...10 mm<sup>2</sup>



CTIN CM 1.6/2.5

- Turned HD and HE contacts
- Turned HX contacts
- ConCept M10, M5 and M3 contacts
- 4-indent crimp
- ~AWG 26...10
- 0.14...6.0 mm<sup>2</sup>

CTIN CM 3.6

- Turned HX contacts
- ConCept M3 contacts
- 4-indent crimp
- ~AWG 16...8
- 1.5...10 mm<sup>2</sup>



Technical data

Description of contact	
Type of contact	
Crimping range	mm <sup>2</sup>
Crimping range 1 (with multiple crimping positions)	mm <sup>2</sup>
Crimping range 2 (with multiple crimping positions)	mm <sup>2</sup>
Crimping range 3 (with multiple crimping positions)	mm <sup>2</sup>
Crimping range 4 (with multiple crimping positions)	mm <sup>2</sup>
Crimping range 5 (with multiple crimping positions)	mm <sup>2</sup>
Tool data	
Length	mm
Weight	g
Note	

Ordering data

Version	
Note	

CTX CM 1.6/2.5	CTX CM 3.6
Turned contacts	Turned contacts
0.14...4	4...10
0.14...0.5	4
0.75...1	6
1.5	10
2.5	
4	
250	250
730	730

Type	Qty.	Order No.
CTX CM 1.6/2.5	1	9018490000
CTX CM 1.6/2.5 ZERT	1	9013690000
CTX CM 3.6	1	9018480000
CTX CM 3.6 ZERT	1	1270320000

A large selection of contacts can be found in our current Heavy-duty Connectors Catalogue

CTIN CM 1.6/2.5	CTIN CM 3.6
Turned contacts	Turned contacts
0.14...6	1.5...10
0.14...6	1.5...10
230	230
1220	1220

Type	Qty.	Order No.
CTIN CM 1.6/2.5	1	9205430000
CTIN CM 3.6	1	9205440000

A large selection of contacts can be found in our current Heavy-duty Connectors Catalogue

### Crimping tools for other contacts

- Ratchet for precise crimping
- Release option in the event of incorrect operation

#### HTX LWL



For fibre-optical cables with

- Core diameter of 1 mm
- Crimping sleeve  $\varnothing$  5.5 mm

**Station 1:** hexagon crimp

**Station 2:** round crimp (for HP connector)



#### Technical data

Description of contact	
Type of contact	
Station 1: A / B	mm
Station 2: A / B	mm
Station 3: A / B	-
C	-
D	-
Tool data	
Length	mm
Weight	g
Note	

#### Ordering data

Version
Note

HTX LWL		
Fibre-optic connector		
	3.15 / 6	
	4.85 / 6	
Tool data		
	200	
	415	
Note		
	H. $\varnothing$ sleeve diameter	

Type	Qty.	Order No.
HTX LWL	1	9011360000

Crimping tools for other contacts

Crimping tools for other contacts

- Ratchet for precise crimping
- Release option in the event of incorrect operation

IE-CT-SC-GOF / IE-CT-LC-GOF

Crimping tools for IP 20 + IP 67 connectors



- For fibre-optic SC/ST, IP 20 and IP 67 connectors
- For fibre-optic LC and IP 67 connectors

IE-CT-SC-POF / IE-CT-SC-GOF-P

Crimping tools for IP 20 + IP 67 connectors



- For polymer fibre-optic SC/ST, IP 20 and IP 67 connectors
- For fibre-optic, Profinet and Mobil cable SC/ST and IP 67 connectors



Technical data

Tool data
Length
Weight
Note

IE-CT-SC-GOF	IE-CT-LC-GOF
250	250
730	730

IE-CT-SC-POF	IE-CT-SC-GOF-P
250	250
730	730

Ordering data

Version
Note

Type	Qty.	Order No.
IE-CT-SC-GOF	1	9205320000
IE-CT-LC-GOF	1	9205330000

Type	Qty.	Order No.
IE-CT-SC-POF	1	9205340000
IE-CT-SC-GOF-P	1	9205350000

Accessories

Note
------

Type	Qty.	Order No.
IE-CT-LC-GOF	1	9205290000
IE-CTI-SC-GOF	1	9205280000
A large selection of plugs and connectors can be found in our current Industrial Ethernet Catalogue		

Type	Qty.	Order No.
IE-CTI-SC-POF	1	9205300000
IE-CTI-SC-GOF-P	1	9205310000
A large selection of plugs and connectors can be found in our current Industrial Ethernet Catalogue		

### Crimping tools for other contacts

- Ratchet for precise crimping
- Release option in the event of incorrect operation
- With end stop for exact positioning of the contacts

### HTX-IE-POF

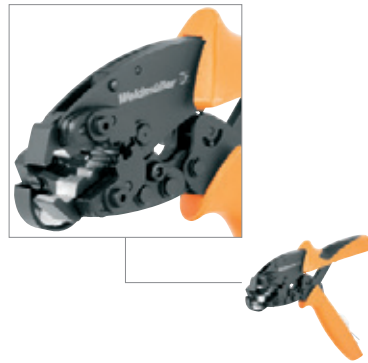

- Only one tool needed for all SC-RJ plug processing steps
- For processing 1 mm thick polymer optical fibres, especially for the PROFINET and ETHERNET/IP-SC-RJ connectors
- For stripping Duplex polymer optical fibres
- The plugs are crimped and the POF fibres are separated, all in a single step
- Cut surfaces do not need to be polished after cutting
- Locator for precise positioning of the SC-RJ plugs
- Ergonomic handles
- High repeat accuracy

Three steps to produce IP 67 connectors:

- 1) Strip the polymer optical fibres
- 2) Crimp and separate
- 3) Crimp the strain relief

### Technical data

Description of contact	
Type of contact	
Tool data	
Length	mm
Weight	g
Note	

HTX-IE-POF	
For 1 mm thick polymer optical fibres	
Length	220
Weight	450
Note	

### Ordering data

Version	
Note	

Type	Qty.	Order No.
HTX-IE-POF	1	1208870000
Note		

## Crimping tools for other contacts

## Crimping tool for other contacts

- Ratchet for precise crimping
- Release option in the event of incorrect operation
- With locator for exact positioning of the contacts

## CTF PV WM4

2.5...6 mm<sup>2</sup>

- For Weidmüller WM4 photovoltaic connectors and similar plugs
- For Multi-Contact MC4 2.5 mm<sup>2</sup> to 6 mm<sup>2</sup> and similar plugs
- For Hirschmann SunCon 4 mm<sup>2</sup> and similar plugs



## Technical data

Description of contact	
Type of contact	
Crimping range	mm <sup>2</sup>
Tool data	
Length	mm
Weight	g
Note	

CTF PV WM4		
F-plug / -sleeve		
Crimping range		2.5...6
Length		250
Weight		730
Note		

## Ordering data

Version
Note

Type	Qty.	Order No.
CTF PV WM4	1	1222870000
Note		

### Crimping tools for other contacts

- Ratchet for precise crimping
- Release option in the event of incorrect operation

#### HTG174 / HTX138 / HTX188



For coaxial connectors such as BNC, TNC and N plugs

- **HTX 138**  
For connectors on Twinax coaxial cable

#### HTG 58 / HTG 59 / HTG 58/59



For coaxial connectors such as BNC and TNC plugs

- With cable RG 58, RG 59, RG 62, RG 71

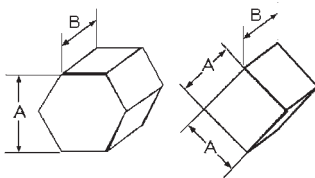

A = Width across flats  
B = Crimping width  
C =  $\varnothing$  Outer sleeve of coaxial plug  
D =  $\varnothing$  Centre contact



### Technical data

Description of contact	
Type of contact	
Station 1: A / B	mm
Station 2: A / B	mm
Station 3: A / B	-
C	mm
D	mm
Tool data	
Length	mm
Weight	g
Note	

### Ordering data

Version
Note

HTG 174	HTX 138	HTX 188
Coaxial connector	Coaxial connector	Coaxial connector
4.52 / 10	8.24 / 10	3.25 / 10
1.72 / 2.3	1.72 / 2.3	1.72 / 2.3
5.4	9.5	3.8
2	2	2
200	200	200
420	420	420

Type	Qty.	Order No.
HTG 174	1	9012410000
HTX 138	1	9012400000
HTX 188	1	9011990000

HTG 58	HTG 58/59	HTG 59
Coaxial connector	Coaxial connector	Coaxial connector
5.4 / 10	5.4 / 10	6.48 / 10
1.72 / 2.3	6.48 / 10	1.72 / 2.3
6.2	6.2	7.5
2	2	2
200	200	200
420	420	420

Type	Qty.	Order No.
HTG 58	1	9012000000
HTG 58/59	1	9012020000
HTG 59	1	9012010000

## Crimping tools for other contacts

### Crimping tools for other contacts

- Ratchet for precise crimping
- Release option in the event of incorrect operation

#### CTX 500 / 501 / 502



For coaxial connectors such as BNC, TNC and N plugs with coaxial cable

#### HTF SUB-D



For SUB-D contacts with open crimping claw

- ~AWG 28...20



### Technical data

Description of contact	
Type of contact	
Station 1: A / B	mm
Station 2: A / B	mm
Station 3: A / B	-
C	mm
D	mm
Tool data	
Length	mm
Weight	g
Note	

CTX 500	CTX 501	CTX 502
Coaxial connector	Coaxial connector	Coaxial connector
10.54 / 12	10.9 / 12	9.3 / 12
2.54 / 3.17	2.45 / 3.17	1.75 / 2.3
12.2	12.6	10.7
2.9	2.8	2
Tool data		
Length	250	250
Weight	730	730
	730	730
Note		

HTF SUB-D	
SUB-D	
Tool data	
Length	200
Weight	438
Note	

### Ordering data

Version	
Note	

Type	Qty.	Order No.
CTX 500	1	9006320000
CTX 501	1	9006370000
CTX 502	1	9006380000
Note		

Type	Qty.	Order No.
HTF SUB-D	1	9013260000
Note		



**Crimping tools for other contacts**

- Ratchet for precise crimping
- Release option in the event of incorrect operation
- With end stop for exact positioning of the contacts
- Contact and insulation are crimped in one step

**HTF RSV 12 / HTF RSV 16**

0.14...2.5 mm<sup>2</sup>



- HTF RSV 16**
- ~AWG 26...16
- HTF RSV 12**
- ~AWG 14...12



**HTF ZRV / HTF DFF / HTF AFK 2.5**

0.2...2.5 mm<sup>2</sup>



- HTF DFF**
- For contacts from the Weidmüller DFF series
- ~AWG 24...14
  - 0.22...2.5 mm<sup>2</sup>
- HTF ZRV**
- For contacts from the Weidmüller ZRV contact system and for MKF flat contacts from Grote & Hartmann and similar designs
- ~AWG 24...17
  - 0.2...1.0 mm<sup>2</sup>
- HTF AFK 2.5**
- For FEKO ZRV contacts from Weidmüller's ZRV contact system or AFK contacts from Grote & Hartmann and similar designs
- ~AWG 24...12
  - 0.2...2.5 mm<sup>2</sup>



**Technical data**

Description of contact	
Type of contact	
Crimping range	AWG
Crimping range 1 (with multiple crimping positions)	AWG
Crimping range 2 (with multiple crimping positions)	AWG
Crimping range 3 (with multiple crimping positions)	-
Crimping range 4 (with multiple crimping positions)	-
Crimping range 5 (with multiple crimping positions)	-
Tool data	
Length	mm
Weight	g
<b>Note</b>	

**Ordering data**

Version
<b>Note</b>

HTF RSV 16	HTF RSV 16 WI
RSV and DSTV-HD	RSV and DSTV-HD
14...12	26...16
14	26...24
12	22...20
	22...20
	16...18
205	205
445	445

Type	Qty.	Order No.
HTF RSV 12	1	9013550000
HTF-RSV 12 ZERT	1	9017890000
HTF RSV 16 WI	1	9013560000
HTF RSV 16 ZERT	1	9017880000

HTF ZRV	HTF DFF	HTF AFK 2.5
Weidmüller ZRV	Weidmüller DFF	Weidmüller FEKO ZRV
0.2...1	0.22...2.5	0.2...2.5
0.2...0.35	0.22...0.35	0.2...3.5
0.5...1	0.5...1	0.5...1
	1.5...2.5	1.5...2.5
200	205	200
436	445	438

Type	Qty.	Order No.
HTF ZRV	1	9014840000
HTF DFF	1	9014140000
HTF AFK 2.5	1	9201040000

## Pressing tools

### Pressing tools

- Pressing tool for modular plug connectors of the WE system (Western Electric and DEC)
- Ratchet for precise crimping
- Release option in the event of incorrect operation

#### 3 functions:

- Pressing of plug connectors
- Pressing of enclosure shielding
- Crimping of cable shielding

### TT 8 RS MP 8



For 8-pole shielded RJ45 plugs

- AWG 27...24

Pressing of IDC contacts



Pressing of shielded enclosures



Crimping of shielded cable



### Technical data

Description of contact	
No. of poles	
Tool data	
Length	mm
Weight	g
Note	

TT 8 RS MP 8	
8	
255	
1251	
Note	

### Ordering data

Version	
Note	

Type	Qty.	Order No.
TT 8 RS MP 8	1	9202800000
Note		
A large selection of RJ 45 connectors can be found in our current Industrial Ethernet Catalogue		

**Pressing tools**

- Pressing tool for modular plug connectors of the WE system (Western Electric and DEC)
- Ratchet for precise crimping
- Release option in the event of incorrect operation

**3 functions:**

- Cutting
- Stripping
- Crimping

**TT 864 RS WE**

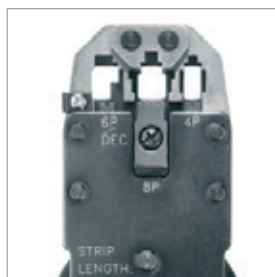

For up to 8-pole flat ribbon or flat-oval data cables

- AWG 28...24
- Connection of:
  - 4-pole WE plugs
  - 6-pole (RJ12) WE plugs
  - 6-pole WE plugs (DEC)
  - 8-pole (RJ45) WE plugs
- Triple crimping for RJ45
- For AMP plugs or versions with similar design
- Other versions on request



**TT 1064 RS WE**

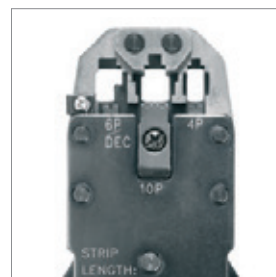

For up to 10-pole flat ribbon or flat-oval data cables

- AWG 28...24
- Connection of:
  - 4-pole WE plugs
  - 6-pole (RJ12) WE plugs
  - 6-pole WE plugs (DEC)
  - 10-pole (RJ45) WE plugs
- Triple crimping for RJ45
- For AMP plugs or versions with similar design
- Other versions on request

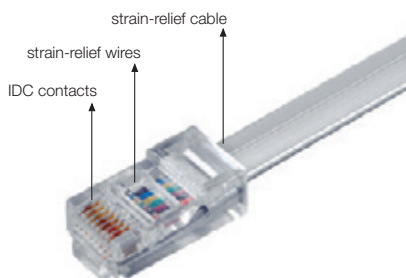

**Technical data**

Tool data	
Length	mm
Weight	g
Note	

**Ordering data**

Version
Note

**Accessories**

Note
------

TT 864 RS		
Length	mm	205
Weight	g	525
Note		

Type	Qty.	Order No.
TT 864 RS	1	9008120000
Note		

Type	Qty.	Order No.
ERSATZMESSERSATZ TT864	1	9008130000
Note		

TT 1064 RS		
Length	mm	205
Weight	g	531
Note		

Type	Qty.	Order No.
TT 1064 RS	1	9008190000
Note		

Type	Qty.	Order No.
ERSATZMESSERSATZ TT864	1	9008130000
Note		

## Mechanical and electro-hydraulic crimping tools

The precision tools from Weidmüller are worldwide in use. This is a responsibility Weidmüller takes seriously, offering comprehensive services to support this global use.

Tools in daily use should always guarantee consistent processing quality even after many working cycles. Weidmüller offers its customers the service of „Tool-Certification“. With this technical test procedure Weidmüller guarantees for the functionality and quality of its tools.



**Crimping tool**

The cross section can be adjusted by turning the in-built revolving dies. So there is no need of changing dies. Furthermore this tool points by small measurements, light weight, optimized transmission ratio and an extremely high crimping quality due to precisely guided dies.

**PZ PK 6/70**



Crimping tool for crimping compression cable lugs DIN 46235, compression connectors DIN 46267, aluminium cable lugs and connectors.

Crimping profile: hexagonal-shape with control embossing

**PZ RK 6/70**



Crimping tool for crimping tubular cable lugs and connectors of the euro-series

Crimping profile: all around WM Style Crimp with control embossing



**Technical data**

Application range	
Cu	
Alu	
Crimping width	mm
Tool data	
Length	mm
Weight	g
Note	

PZ PK 6/70		
Cu	=	6...70 mm <sup>2</sup> (K 5 - K 16)
Alu	=	10...50 mm <sup>2</sup> (K 10 - K 16)
Crimping width		5
Length		515
Weight		2000
Note		

PZ RK 6/70		
Cu	=	6...70 mm <sup>2</sup>
Crimping width		5
Length		515
Weight		2000
Note		

**Ordering data**

Version
Note

Type	Qty.	Order No.
PZ PK 6/70	1	1500470000
Note		

Type	Qty.	Order No.
PZ RK 6/70	1	1500440000
Note		

**Crimping tools**

The cross section can be adjusted by turning the in-built revolving crimp insert. So there is no need of changing crimp inserts.

**PZ PK 10/120**



Crimping tool for crimping compression cable lugs DIN 46235, compression connectors DIN 46267, aluminium cable lugs and connectors

Crimping profile: hexagonal-shape with control embossing

**PZ RK 10/120**



Crimping tool for crimping tubular cable lugs and connectors of the euro-series. Furthermore this tool points by small measurements, light weight and an extremely high crimping quality due to WM-crimping.

Crimping profile: all around WM Style Crimp with control embossing

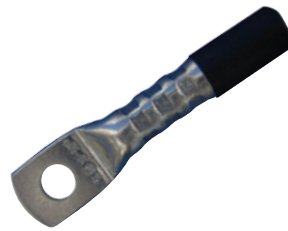

**Technical data**

Application range	
Cu	
Alu	
Crimping width	mm
Tool data	
Length	mm
Weight	g
Note	

PZ PK 10/120		
Cu	=	10...20 mm <sup>2</sup> (K 6 - K 20)
Alu	=	10 ...70 mm <sup>2</sup> (K 10 - K 18)
Crimping width		5
Length		660
Weight		4100
Note		

PZ RK 10/120		
Cu	=	10...120 mm <sup>2</sup>
Crimping width		5
Length		660
Weight		4100
Note		

**Ordering data**

Version	
Note	

Type	Qty.	Order No.
PZ PK 10/120	1	1500480000
Note		

Type	Qty.	Order No.
PZ RK 10/120	1	1500450000
Note		

**Crimping tools for connectors**

- For insulated and uninsulated cable lugs and connectors
- Mechanical function ensures safe and manageable operations under different environmental conditions
- Precision engineering means a high pressing force with little physical effort
- Fast feed helps pre-centreing and extraction of the connecting parts
- Ratchet for high-quality, flawless crimping
- Release option in the event of incorrect operation
- Comprehensive range of standard-compliant crimp inserts

**MTR 35**

6...50 mm<sup>2</sup>



- ~AWG 16...0000
- Tubular cable lugs from 6...50 mm<sup>2</sup>
- Wire-end ferrules from 6...50 mm<sup>2</sup>
- Retractable head for easy withdrawal of crimped connection



**Technical data**

Description of contact	
Pressing force / Deviation	kN/mm
Crimping range for copper tube connector	mm <sup>2</sup>
Crimping range for insulated connectors	mm <sup>2</sup>
Crimping range of wire end ferrule	mm <sup>2</sup>
Tool data	
Length / Weight	mm/kg
Note	

MTR 35	
25 / 8	
6...50	
10...25	
25...50	
270 / 1.3	
For more details see crimp inserts on the following pages	

**Ordering data**

Version
Note

Type	Qty.	Order No.
MTR 35	1	9017500000

**Accessories**

Note

Type	Qty.	Order No.
MTR 35	1	9017840000
Crimping inserts see on the following pages		



**Crimping inserts WM-shape**

- for crimping cable lugs and connectors of the euro-series

**Ordering data**

mm <sup>2</sup>	Crimp. width mm	Order No.
6	5	1500490000
10	5	1500500000
16	5	1500520000
25	5	1500530000
35	5	1500540000
50	5	1500550000



**Crimping inserts hexagonal-shape**

- for crimping compression copper cable lugs DIN 46 235
- compression copper connectors DIN 46 267 part 1
- aluminium and aluminium/ copper cable lugs and connectors

**Ordering data**

Code no.	Cu mm <sup>2</sup>	Al mm <sup>2</sup>	Crimp. width mm	Order No.
5	6	-	5	1500580000
6	10	-	5	1500590000
8	16	-	5	1500600000
10	25	10	5	1500620000
12	35	16+25	5	1500630000
14	50	35	5	1500640000



**Indent Crimping inserts**

- for compression terminals DIN 46234
- pin cable lugs DIN 46230
- connector DIN 46341 part 1

**Ordering data**

mm <sup>2</sup>	Crimp. width mm	Order No.
6	5	1500650000
10	7	1500670000
16	10	1500680000
25	10	1500690000
35	10	1500700000



**Crimping inserts**

- for insulated compression terminals

**Ordering data**

mm <sup>2</sup>	Crimp. width mm	Order No.
10	7	1500720000
16	7	1500730000
25	10	1500740000



**Crimping inserts square-shape**

- for insulated and non insulated wire-end ferrules
- crimping width 18 mm

**Ordering data**

mm <sup>2</sup>	Crimp. width mm	Order No.
6	18	1500750000
10	18	1500770000
16	18	1500780000
25	18	1500790000
35	18	1500800000
50	18	1500820000



## Hydraulic battery crimping tool 45 kN

Battery-powered hydraulic compression hand-crimping tool for crimp cable lugs and connectors up to 150 mm<sup>2</sup>.

- extremely quick processing due to a three-stage axial piston pump
- wide application range up to 150 mm<sup>2</sup>
- 270° revolving head with quick opening and closing
- because of a flap closure easy working also in places with difficult access
- automatic pressure limits and monitoring through pressure sensor
- engine shutdown and automatic retract after completed pressing
- electronic regulation and supervision of the press process
- manual retract
- save of all crimps and error messages on internal memory
- selections of all cycles and error messages about USB interface
- no uncompleted pressing cycles through ongoing monitoring of the rest battery cargo load
- controlled engine drive to the life extension of gearbox, engine and battery
- integrated service management and software updates about the USB interface
- fast tool return pipe through high return flow volume
- sleep-mode; maintenance indication and battery control
- integrated, intelligent electronics assembly with multifunctional LED
- mini-USB interface for all standard computer systems for:
  - Crimping force graph and error indication
  - Service Check up
- Li-Ion battery with charge level indicator: 18 V 1.5 Ah

## EPG 45

6...150 mm<sup>2</sup>



Included in delivery

- Hydraulic tool including 1x battery and 1x battery charger
- Manual
- Software
- USB connection cable
- Carrying bag for tool and Crimping inserts



## Technical data

Description of contact	
Press capacity / piston stroke	kN/mm

Tool data	
Length x width x height / weight	mm/kg
<b>Note</b>	

## Ordering data

Version

Note

## Accessories

Replacement battery - Li-Ion 18 V, 1.5 Ah
---

Note

EPG 45	
45 / 16	

370 x 123 x 80 / 2.3
----------------------

Type	Qty.	Order No.
EPG 45	1	1500830000
EPG 45 120 V	1	1508780000

Type	Qty.	Order No.
AKKU EPG 45	1	1500840000
Ladegerät EPG	1	1509370000
Ladegerät EPG 120 V	1	1509380000

Range of application	Ø mm <sup>2</sup>
Crimping inserts WM-shape for euro-series	6 - 150
Hexagonal crimping inserts for compression cable lugs (DIN 46235) + connectors (DIN 46267)	6 - 150 (K5-K22)
Mandrel crimping inserts for compression terminals DIN 46234	6 - 50
Crimping inserts for insulated compression terminals	10 - 50
Crimping inserts square-shape for insulated and non insulated wire-end ferrules	6 - 50
Rounding crimping inserts for rounding sector-shaped copper and aluminium conductors	10 - 150

**Crimping tools for connectors**

- For insulated and uninsulated cable lugs and connectors
- Mechanical function ensures safe and manageable operations under different environmental conditions
- Precision engineering means a high pressing force with little physical effort
- Fast feed helps pre-centreing and extraction of the connecting parts
- Ratchet for high-quality, flawless crimping
- Release option in the event of incorrect operation
- Comprehensive range of standard-compliant crimp inserts

**MTR 110**

6...120 mm<sup>2</sup>



- ~AWG 16...0000
- Tubular cable lugs from 6...120 mm<sup>2</sup>
- Wire-end ferrules from 6...50 mm<sup>2</sup>
- Retractable head for easy withdrawal of crimped connection



**Technical data**

Description of contact	
Pressing force / Deviation	kN/mm
Crimping range for copper tube connector	mm <sup>2</sup>
Crimping range for insulated connectors	mm <sup>2</sup>
Crimping range of wire end ferrule	mm <sup>2</sup>

Tool data	
Length / Weight	mm/kg

**Note**

**Ordering data**

Version

**Note**

**Accessories**

Type	Qty.	Order No.
MTR 110	1	9018020000

**Note**

MTR 110	
Pressing force / Deviation	55 / 10
Crimping range for copper tube connector	6...120
Crimping range for insulated connectors	10...16
Crimping range of wire end ferrule	6...50
Length / Weight	420 / 2

For more details see crimp inserts on the following pages

Type	Qty.	Order No.
MTR 110	1	9018040000

Crimping inserts see on the following pages

**Crimping inserts WM-shape**

- for crimping cable lugs and connectors of the euro-series

**Ordering data**

mm <sup>2</sup>	Crimp. width mm	Order No.
6	7	1500850000
10 / 70	7 / 5	1500870000
16 / 35	7 / 10	1500920000
25 / 50	12 / 5	1500880000
95	5	1500890000
120	5	1500900000
150*	5	1994550000

\* only EPG 45

**Crimping inserts hexagonal-shape**

- for crimping compression copper cable lugs DIN 46 235
- compression copper connectors DIN 46 267 part 1
- aluminium and aluminium/copper cable lugs and connectors

**Ordering data**

Code no.	Cu mm <sup>2</sup>	Al mm <sup>2</sup>	Crimp. width mm	Order No.
5	6	-	7	1500930000
6/16	10/70	-/50	7/5	1500940000
8/12	16/35	-/16+25	12/10	1500950000
10/14	25/50	10/35	12/5	1500970000
18	95	70	5	1500980000
20	120	-	5	1500990000
22	150*	-	5	1994540000

\* only EPG 45

**Indent Crimping inserts**

- for compression terminals DIN 46234
- pin cable lugs DIN 46230
- connector DIN 46341 part 1

**Ordering data**

mm <sup>2</sup>	Crimp. width mm	Order No.
6	6	1501290000
10	8	1501320000
16	10	1501330000
25	12	1501340000
35	12	1501350000
50	12	1501370000
70	12	1501380000

**Crimping inserts**

- for insulated compression terminals

**Ordering data**

mm <sup>2</sup>	Crimp. width mm	Order No.
10	7	1501000000
16	7	1501020000

**Crimping inserts square-shape**

- for insulated and non insulated wire-end ferrules
- crimping width 19 mm

**Ordering data**

mm <sup>2</sup>	Crimp. width mm	Order No.
6	19	1501030000
10	19	1501040000
16	19	1501050000
25	19	1501070000
35	19	1501170000
50	19	1501180000



### Prerounding die sets

- for rounding sector-shaped copper and aluminium conductors crimping width: 12 mm

sm = stranded conductors

se = solid conductors

### Ordering data

mm <sup>2</sup> sm	mm <sup>2</sup> se	Crimp. width mm	Order No.
10	-	12	1501190000
16	-	12	1501200000
25	35	12	1501220000
35	50	12	1501230000
50	70	12	1501240000
70	95	12	1501250000
95	120	12	1501270000
120	150	12	1501280000



**Crimping tools for connectors**

- For insulated and uninsulated cable lugs and connectors
- Mechanical function ensures safe and manageable operations under different environmental conditions
- Precision engineering means a high pressing force with little physical effort
- Fast feed helps pre-centreing and extraction of the connecting parts
- Ratchet for high-quality, flawless crimping
- Release option in the event of incorrect operation
- Comprehensive range of standard-compliant crimp inserts

**MTR 160**

10...240 mm<sup>2</sup>



- ~AWG 8
- Tubular cable lugs from 10...240 mm<sup>2</sup>

**MTR 300**

10...300 mm<sup>2</sup>



- ~AWG 8
- Tubular cable lugs from 10...300 mm<sup>2</sup>
- Retractable head for easy withdrawal of crimped connection
- Turntable presses: 25...240 sm; 35...240 se

**Technical data**

Description of contact	
Pressing force / Deviation	kN/mm
Crimping range for copper tube connector	mm <sup>2</sup>
Crimping range for insulated connectors	mm <sup>2</sup>
Tool data	
Length / Weight	mm/kg
Note	

**Ordering data**

Version
Note

**Accessories**

Type	Qty.	Order No.
MTR 160	1	9017270000
Note		

MTR 160		
Pressing force / Deviation	100 / 16	
Crimping range for copper tube connector		
Crimping range for insulated connectors		
Tool data		
Length / Weight	540 / 4	
Note		
For more details see crimp inserts on the following pages sm: sector conductor stranded; se: sector single conductor		

Type	Qty.	Order No.
MTR 160	1	9017250000
Note		

Type	Qty.	Order No.
MTR 160	1	9017270000
Note		
Crimping inserts see on the following pages		

MTR 300		
Pressing force / Deviation	100 / 16	
Crimping range for copper tube connector	10...300	
Crimping range for insulated connectors	10...120	
Tool data		
Length / Weight	540 / 4	
Note		
For more details see crimp inserts on the following pages sm: sector conductor stranded; se: sector single conductor		

Type	Qty.	Order No.
MTR 300	1	9021390000
Note		

Type	Qty.	Order No.
MTR 300	1	9021420000
Note		
Crimping inserts see on the following pages		

**MTR 160**



	Cross-section [mm <sup>2</sup> ]	Code to DIN 48083	Crimping width [mm]	Order No.
<b>Die sets for copper tube cable lugs and connectors DIN 46235</b>				
	10	6	7,0	9020900000
	16	8	7,0	9020910000
	25	10	7,0	9020920000
	35	12	7,0	9020930000
	50	14	7,0	9020940000
	70	16	7,0	9020950000
	95	18	7,0	9020960000
	120	20	7,0	9020970000
	150	22	7,0	9020980000
	185	25	7,0	9020990000
	240	28	7,0	9021000000



**MTR 300**

	Cross-section [mm <sup>2</sup> ]	Code to DIN 48083	Crimping width [mm]	Order No.
<b>Die sets for copper tube cable lugs and connectors DIN 46235</b>				
	10	6	7,0	9021430000
	16	8	7,0	9021440000
	25	10	7,0	9021450000
	35	12	7,0	9021460000
	50	14	7,0	9021470000
	70	16	7,0	9021480000
	95	18	7,0	9022290000
	120	20	7,0	9022300000
	150	22	7,0	9022310000
	185	25	7,0	9022320000
	240	28	7,0	9022330000
	300	32	7,0	9022340000

	Cross-section [mm <sup>2</sup> ]	Crimping width [mm]	Order No.
<b>Die sets for copper tube cable lugs and connectors standard Types</b>			
	10/25	9,8	9021750000
	16/35	9,8	9021760000
	50	8,0	9021770000
	70	8,0	9021780000
	95	8,0	9021790000
	120	8,0	9021800000
	150	8,0	9021810000
	185	8,0	9021820000
	240	8,0	9021830000

	Cross-section [mm <sup>2</sup> ]	Crimping width [mm]	Order No.
<b>Die sets for copper tube cable lugs and connectors standard Types</b>			
	10/25	9,8	9024010000
	16/35	9,8	9024400000
	50	8,0	9024410000
	70	8,0	9024420000
	95	8,0	9024430000
	120	8,0	9025210000
	150	8,0	9025220000
	185	8,0	9025230000
	240	8,0	9028020000

	Cross-section [mm <sup>2</sup> ]	Order No.
<b>Die sets for insulated cable lugs and connectors, DIN 46234, DIN 46230</b>		
	10	9021300000
	16	9021310000
	25	9021320000
	35	9021330000
	50	9021340000
	70	9021350000
	95	9021360000
	120	9021370000
	150	9021380000
	with control mark	

	Cross-section [mm <sup>2</sup> ]	Order No.
<b>Stamp and dies for copper cable lugs and connectors, DIN 46234, DIN 46230</b>		
	<b>2-way die</b>	
	16/35	9022360000
	10/70	9022350000
	25/50	9022370000
	<b>Stamp</b>	
	10 - 70	9022990000
	<b>Single die</b>	
	95	9022380000
	120	9022390000
	150	9022400000
	<b>Stamp</b>	
	95-150	9023110000

	Cross-section [mm <sup>2</sup> ]	Order No.
<b>Die sets for insulated cable lugs and connectors, DIN 46231, 46237</b>		
	10	9016180000
	16	9016190000
	25	9016200000
	35	9016210000
	50	9016220000
	70	9016230000

	Cross-section [mm <sup>2</sup> ]	Order No.
<b>Die sets for insulated cable lugs and connectors, DIN 46231, 46237</b>		
	10	9016180000
	16	9016190000
	25	9016200000
	35	9016210000
	50	9016220000
	70	9016230000

	Cross-section [mm <sup>2</sup> ]	Order No.
<b>Prerounding die sets Cu/Al for sectored cable</b>		
	25 sm/35 se	9016260000
	35 sm/50 se	9016270000
	50 sm/70 se	9016280000
	70 sm/95 se	9016290000
	95 sm/120 se	9016370000
	120 sm/150 se	9016380000
	150 sm/185 se	9016390000
	185 sm/240 se	9016440000

	Cross-section [mm <sup>2</sup> ]	Order No.
<b>Prerounding die sets Cu/Al for sectored cable</b>		
	25 sm/35 se	9016260000
	35 sm/50 se	9016270000
	50 sm/70 se	9016280000
	70 sm/95 se	9016290000
	95 sm/120 se	9016370000
	120 sm/150 se	9016380000
	150 sm/185 se	9016390000
	185 sm/240 se	9016440000



## Battery-powered compression tool APG 55

Battery-powered hydraulic compression tool for crimping cable lugs and connectors up to 240 mm<sup>2</sup>.

- extremely quick processing due to a two-stage hydraulic pump
- 270° revolving head with quick opening and closing
- integrated pressure relief valve, false pressings cause no damage at tool nor dies
- Pressure-relief-button in one-hand operation is able to press from both sides. (for right-and left handed persons)
- integrated overpressure valve, in case of wrong pressings, no damage of tools or inserts
- lithium-ion-battery without memory effect, self discharges very low
- high capacity due 3.0 Ah battery
- fastening eye for balance and carrying strap available
- ergonomic handle with a balanced weight distribution for sure work free of tiredness
- case, handle shell and pressure discharge key completely from isolated and push-firm plastic material
- universal usage: dies for all versions of cable lugs and connectors are available
- integrated electronic module for:
  - permanent accumulator-loading state control
  - supervision of the working process and state announcement
  - announcement of the next service intervall
  - mistake announcement at possible disturbances

## APG 55

6...240 mm<sup>2</sup>



Included in delivery

- Battery-powered compression tool with battery and battery charger
- supporting loop for transport and safety
- transport plastic case



## Technical data

Description of contact	
Press capacity	kN
Operating voltage	Volt
Battery charger	
Time of loading	

Tool data	
Length x width x height / weight	mm/kg
<b>Note</b>	

## Ordering data

Version

Note

## Accessories

Replacement battery - Li-Ion 18 V, 1.5 Ah
---

Note

APG 55	
approx. 55	
14.4	
220-240V 50-60Hz 7.2-18V	
approx. 50 minutes	

95 x 350 x 310 mm / 3.6 kg (incl. battery)
--

Type	Qty.	Order No.
APG 55	1	1501390000
APG 55 120 V	1	1508790000

Type	Qty.	Order No.
Ersatz Akku APG	1	1502140000
Ladegerät APG	1	1502170000
Ladegerät APG 120 V	1	1509390000

## Crimping tools APG 55 and HPG 55

## Hand-operated hydraulic crimping tool HPG 55

Hand-operated hydraulic crimping tool for crimping cable lugs and connectors up to 240 mm<sup>2</sup>.

- extremely quick processing due to a two-stage hydraulic pump
- because of a flap closure easy working also in places with difficult access
- extremely light, handy and compact construction form
- integrated pressure relief valve, false pressings cause no damage at tool nor dies
- universal usage: dies for all versions of cable lugs are available
- delivery completely transport plastic case

## HPG 55

6...240 mm<sup>2</sup>



- 180° revolving head with quick opening and closing



## Technical data

Description of contact	
Press capacity / piston stroke	kN/mm
Tool data	
Length / Weight	mm/kg
Note	

HPG 55		

## Ordering data

Version
Note

Type	Qty.	Order No.
HPG 55	1	1501400000

## Accessories

Type
Note

Type	Qty.	Order No.

**Crimping inserts WM-shape**

- for crimping cable lugs and connectors of the euro-series

**Ordering data**

mm <sup>2</sup>	Crimp. width mm	Order No.
6	7	1501420000
10 / 70	7 / 5	1501430000
16 / 35	7 / 5	1501440000
25 / 50	12 / 5	1501450000
95	5	1501470000
120	5	1501480000
150	5	1501490000
185	5	1501500000
240	5	1501520000

**Crimping inserts hexagonal-shape**

- for crimping compression copper cable lugs DIN 46 235
- compression copper connectors DIN 46 267 part 1
- aluminium and aluminium/copper cable lugs and connectors

**Ordering data**

Code no.	Cu mm <sup>2</sup>	Al mm <sup>2</sup>	Crimp. width mm	Order No.
5	6	-	7	1501530000
6/16	10/70	-/50	7/5	1501540000
8/12	16/35	-/16+25	12/5	1501550000
10/14	25/50	10/35	12/5	1501570000
18	95	70	5	1501580000
20	120	-	5	1501590000
22	150	95+120	5	1501600000
25	185	150	5	1501620000

**Indent Crimping inserts**

- for compression terminals DIN 46234
- pin cable lugs DIN 46230
- connector DIN 46341 part 1

**Ordering data**

mm <sup>2</sup>	Crimp. width mm	Order No.
6	6	1501630000
10	8	1501640000
16	10	1501650000
25	12	1501670000
35	12	1501680000
50	12	1501690000
70	12	1501700000
95	12	1501720000
120	12	1501730000

**Crimping inserts**

- for insulated compression terminals

**Ordering data**

mm <sup>2</sup>	Crimp. width mm	Order No.
10	7	1501740000
16	7	1501750000
25	10	1501770000
35	10	1501780000
50	10	1501790000
70	7	1502250000

**Crimping inserts square-shape**

- for insulated and non insulated wire-end ferrules
- crimping width 19 mm

**Ordering data**

mm <sup>2</sup>	Crimp. width mm	Order No.
6	19	1502270000
10	19	1502280000
16	19	1502290000
25	19	1502300000
35	19	1502320000
50	19	1502330000
70	19	1502340000
95	19	1502370000
120	19	1502380000



## Crimping tools APG 80 and HPG 80

### Battery-powered compression tool APG 80

Battery-powered hydraulic compression tool for crimping cable lugs and connectors up to 300 mm<sup>2</sup>.

- extremely quick processing due to a two-stage hydraulic pump
- wide application range up to 300 mm<sup>2</sup>
- 360° revolving head with quick opening and closing
- Pressure-relief-button in one-hand operation is able to press from both sides. (for right-and left handed persons)
- suitable for cutting cables up to 28 mm outside diameter
- integrated overpressure valve, in case of wrong pressings, no damage of tools or inserts
- lithium-ionen-battery without memory effect, self-discharges very low
- high capacity due to 3.0 Ah-battery
- fastening eye for balance and carrying strap available
- ergonomic handle with a balanced weight distribution for sure work free of tiredness
- case, handle shell and pressure discharge key completely from isolated and push-firm plastic material
- universal usage: dies for all versions of cable lugs and connectors are available
- integrated electronic module for:
  - permanent accumulator-loading state control
  - supervision of the working process and state announcement
  - announcement of the next service intervall
  - mistake announcement at possible disturbances

### APG 80

6...300 mm<sup>2</sup>



Included in delivery

- Battery-powered compression tool with battery and battery charger
- supporting loop for transport and safety
- transport plastic case



### Technical data

Description of contact	
Press capacity	kN
Operating voltage	
Battery charger	
Time of loading	
Tool data	
Dimensions (w <sup>x</sup> l <sup>x</sup> h) / Weight	mm/kg
Note	

### Ordering data

Version
Note

### Accessories

Type	Qty.	Order No.
Ersatz Akku APG	1	1502140000
Ladegerät APG	1	1502170000
Ladegerät APG 120 V	1	1509390000
Note		

APG 80	
approx. 80	
14.4 Volt	
220-240 V, 50-60 Hz, 7.2-18 V	
approx. 50 minutes	
95 x 406 x 310 / 5.4 (incl. battery)	
Note	

Type	Qty.	Order No.
APG 80	1	1502390000
APG 80 120 V	1	1508820000
Note		

Type	Qty.	Order No.
Ersatz Akku APG	1	1502140000
Ladegerät APG	1	1502170000
Ladegerät APG 120 V	1	1509390000
Note		

**Hand-operated hydraulic compression tool HPG 80**

hand-operated hydraulic compression tool for crimping cable lugs and connectors up to 300 mm<sup>2</sup>.

- extremely quick processing due to a two-stage hydraulic pump
- wide application range up to 300 mm<sup>2</sup>
- 360° revolving head with quick opening and closing
- integrated pressure relief valve, false pressings cause no damage at tool nor dies
- universal usage: dies for all versions of cable lugs are available

**HPG 80**

6...300 mm<sup>2</sup>



- Included in delivery
- transport plastic case



**Technical data**

Description of contact	
Press capacity	kN
Tool data	
Dimensions (Length) / Weight	mm/kg
Note	

APG 80		
		approx. 80

**Ordering data**

Version		
Note		

Type	Qty.	Order No.
APG 80	1	1502420000

**Accessories**

Note		

Type	Qty.	Order No.

**Crimping inserts WM-shape**

- for crimping cable lugs and connectors of the euro-series

**Ordering data**

mm <sup>2</sup>	Crimp. width mm	Order No.
6	7	1502430000
10	7	1502440000
16	7	1502470000
25	12	1502480000
35	12	1502490000
50	12	1502500000
70	12	1502520000
95	12	1502530000
120	12	1502540000
150	5	1502550000
185	5	1502570000
240	7	1502580000
300	7	1502590000



**Crimping inserts hexagonal-shape**

- for crimping compression copper cable lugs DIN 46 235
- compression copper connectors DIN 46 267 part 1
- aluminium and aluminium/copper cable lugs and connectors

**Ordering data**

Code no.	Cu mm <sup>2</sup>	Al mm <sup>2</sup>	Crimp. width mm	Order No.
5	6	-	7	1502600000
6	10	-	7	1502620000
8	16	-	12	1502630000
10	25	16	12	1502640000
12	35	25	12	1502650000
14	50	35	12	1502670000
16	70	50	12	1502680000
18	95	70	10	1502690000
20	120	-	10	1502700000
22	150	95 + 120	5	1502720000
25	185	150	5	1502730000
28	240	185	5	1502740000
32	300	240	7	1502750000
34	-	300	13	1502780000



**Indent Crimping inserts**

- for compression terminals DIN 46234
- pin cable lugs DIN 46230
- connector DIN 46341 part 1

**Ordering data**

mm <sup>2</sup>	Crimp. width mm	Order No.
6	6	1502820000
10	8	1502830000
16	10	1502840000
25	11	1502850000
35	11	1502870000
50	16	1502880000
70	16	1502890000
95	16	1502900000
120	16	1502790000
150	16	1502800000
185	8	1501800000
240	8	1501820000



**Crimping inserts**

- for insulated compression terminals

**Ordering data**

mm <sup>2</sup>	Crimp. width mm	Order No.
10	7	1501830000
16	7	1501840000



**Crimping inserts square-shape**

- for insulated and non insulated wire-end ferrules
- crimping width 24 mm (10...120 mm<sup>2</sup>)
- crimping width 38 mm (150...240 mm<sup>2</sup>)

**Ordering data**

mm <sup>2</sup>	Crimp. width mm	Order No.
10	24	1502000000
16	24	1502020000
25	24	1502030000
35	24	1502040000
50	24	1502050000
70	24	1502070000
95	24	1502080000
120	24	1502090000
150	38	1502100000
185	38	1502120000
240	38	1502130000

**Prerounding die sets**

- for rounding sector-shaped copper and aluminium conductors crimping width:

sm = stranded conductors

se = solid conductors

**Ordering data**

mm <sup>2</sup> sm	mm <sup>2</sup> se	Crimp. width mm	Order No.
10	-	16	1501850000
16	-	16	1501870000
25	35	16	1501880000
35	50	16	1501890000
50	70	16	1501900000
70	95	16	1501920000
95	120	16	1501930000
120	150	16	1501940000
150	185	16	1501970000
185	240	16	1501980000
240	300	16	1501990000





## Battery-powered hydraulic cable cutter AKT 50

### Battery-powered hydraulic cable cutter AKT 50

for cut of fine wiring aluminium and copper cables (without steel insertion) up to 50 mm outside diameter

- extremely quick processing due to a two-stage hydraulic pump
- 360° revolving head with quick opening and closing
- Pressure-relief-button in one-hand operation is able to press from both sides. (for right-and left handed persons)
- lithium-ionen-battery without memory effect, self-discharges very low
- high capacity due to 3.0 Ah-battery
- fastening eye for balance and carrying strap available
- ergonomic handle with a balanced weight distribution for sure work free of tiredness
- case, handle shell and pressure discharge key completely from isolated and push-firm plastic material
- integrated electronic module for:
  - permanent accumulator-loading state control
  - supervision of the working process and state announcement
  - announcement of the next service intervall
  - mistake announcement at possible disturbances

### AKT 50

Ø 6 ... 50 mm



Included in delivery

- cable cutter, Battery, battery charger
- supporting loop for transport and safety
- transport plastic case



### Technical data

Description of contact	
Cutting force	kN
Operating voltage	
Battery charger	
Time of loading	
Tool data	
Dimensions (w×l×h) / Weight	mm/kg
Note	

### Ordering data

Version
Note

### Accessories

Type	Qty.	Order No.
Note		

AKT 50		
approx. 60		
14,4 Volt		
220-240 V, 50-60 Hz, 7,2-18 V		
approx. 50 minutes		
95 x 465 x 310 / 4,9 (incl. battery)		
Note		

Type	Qty.	Order No.
AKT 50	1	1502190000
Note		

Type	Qty.	Order No.
Note		

## AKKU APG



## Technical data

Replacement battery - Li-Ion	14.4 V, 3.0 Ah
Weight	0.56 kg

## Ordering data

Type	Qty.	Order No.
Battery APG	1	1502140000

## BATTERY CHARGER APG



Standard-battery charger	220-240 V	50-60 Hz
Voltage range	7.2-18 V	
Time of loading	approx. 50 minutes	
Weight	0.55 kg	

## Ordering data

Type	Qty.	Order No.
Ladegerät APG	1	1502170000
Ladegerät APG 120 V	1	1509390000

## AKKU EPG 45



Replacement battery - Li-Ion for EPG 45	18 V, 1,5 Ah
Weight	0,41 kg

## Ordering data

Type	Qty.	Order No.
AKKU EPG 45	1	1500840000

## BATTERY CHARGER EPG



Standard-Battery charger	220-240 V	50-60 Hz
Voltage range	7.2-18 V	
Time of loading	approx. 50 minutes	
Weight	0.55 kg	

## Ordering data

Type	Qty.	Order No.
Ladegerät EPG	1	1509370000
Ladegerät EPG 120 V	1	1509380000



### Insertion tool for twisted-pair cable

For connecting twisted-pair cable to terminal rails with IDC contacts e.g. in main and floor distributors, and in modular wall junction boxes for structured building cabling.

### PDT



The punch-down tool has the following features:

- Mechanism made from metal components
- Adjustable pressing force for conductor sizes AWG 20 to AWG 28
- Different blades for connector blocks of type 110 from AT&T, type 66, type LSA Plus from Krone (standard and scissors cutting function) as well as for telephone outlets 630A6
- Incision blades with 2 functions: incision or incision with cutting off of remaining conductor
- Storage compartment for one blade



- A = PD blade 110
- B = PD blade 66
- C = PD blade 630
- D = PD blade Krone LSA (standard)
- E = PD blade Krone LSA (scissors)

#### Technical data

Length / Width / Height	mm
Weight	g
Note	

PUNCH DOWN TOOL PDT	
160 / 37 / 29	
142	
Note	

#### Ordering data

Version	
Note	

Type	Qty.	Order No.
PUNCH DOWN TOOL PDT	1	9013970000
(without blade)		

#### Accessories

Note	

Type	Qty.	Order No.
ERME LSA PLUS SCHERE	1	9014050000
ERME 110 PDT	1	9013960000
ERME 630 PDT	1	9013990000
ERME 66 PDT	1	9013980000
ERME LSA PLUS STANDARD	1	9014000000

## Disconnect

### Removal Tool CM3, CM5, HD

#### Removal Tool HD

#### CM3 Removal Tool

Contact release tool for freeing crimp contacts in the Concept CM3 module

#### CM5 Removal Tool

Contact release tool for freeing crimp contacts in the Concept CM5 module

#### HD Removal Tool

Contact release tool for freeing crimp contacts in the Concept CM10 module

#### Ordering data

Type	Qty.	Order No.
REMOVAL TOOL HD	1	1866730000
Removal Tool CM 3	1	1866710000
Removal Tool CM 5	1	1866720000



### Removal Tool CM20

#### Removal Tool CM 20

Contact release tool for freeing crimp contacts in the Concept CM20 module

#### Ordering data

Type	Qty.	Order No.
Removal Tool CM 20	1	1866740000



### Removal Tool HE

#### Removal Tool HE

Contact release tool for the ConCept HE module and for releasing crimp contacts in the ConCept CM4 module

#### Ordering data

Type	Qty.	Order No.
Removal Tool HE	1	1866750000



### HDC-DW RSV 1.6

Contact release tool for the ConCept module, or for dismantling stamped HD pin and socket contacts of type CB/CS and GB/GS

#### Ordering data

Type	Qty.	Order No.
DW RSV 1.6	1	9004530000



### DFF-C

Disengaging tool for removing crimp contacts clipped in BLAC enclosures

#### Ordering data

Type	Qty.	Order No.
DFF-C ENTRIEGELUNGSWZ.	1	9014210000



### Removal Tool AFK

Contact release tool for removing FEKO ZRV contacts.

#### Ordering data

Type	Qty.	Order No.
Removal Tool AFK	1	1866760000



**Replacement sleeve for contact release tool****Ordering data**

Type	Qty.	Order No.
HÜLSE REMOVAL TOOL HD	5	1044100000
HÜLSE REMOVAL TOOL CM 3	5	1044080000
HÜLSE REMOVAL TOOL CM 5	5	1044090000



## Tools for polymer optical fibres

## HTX-HDC/POF

## POF crimping

Crimping of „polymer optical fibre“ (POF) fibre-optical contacts.

- For plug and socket
- Ratchet for precise crimping
- Unlocks in case of incorrect operation
- Locator for precise contact positioning

## Contacts:

- Fibre-optic cable HD contact socket for Ø1.0 mm POF
- Fibre-optic cable HD contact pin for Ø 1.0 mm POF

## Ordering data

Type	Qty.	Order No.
HTX-HDC/POF	1	9010950000

## Technical data

Length	200 mm
Weight	438 g



## PB LWL/POF / PS LWL/POF

## POF polishing

For processing the cut surface of fibre-optic cables with polymer optical fibre (POF).

- Buffing disc (PS LWL/POF)
- Buffing sheet (PB LWL/POF)

## Ordering data

Type	Qty.	Order No.
PB LWL/POF	1	9020400000
PS LWL/POF	1	9020390000



## AM LWL/POF

## POF stripping

Stripping fibre-optic cables. Fibre-optic cable with polymer optical fibres (POF).

- Longitudinal stop with scale is built into the tool
- Stripping direction is lengthwise to the fibre
- No damage to the optical fibre

## Ordering data

Type	Qty.	Order No.
AM LWL/POF	1	9020360000



## LWL-stripax

Stripping and cutting tool for plastic fibre-optic cables with 1 mm diameter inner conductor

- Stripping length adjustable via end stop
- Automatic opening of the clamping jaws after stripping

## Ordering data

Type	Qty.	Order No.
M-D-STRIPAX LWL	1	9003750000



## Technical data

Max. stripping performance	
Cable type	
Conductor diameter	-
Stripping length, max.	-
Tool data	
Length	mm
Weight	g
Note	

M-D-STRIPAX LWL	
POF conductor with an inner conductor of 1 mm Ø	
...	1
Stripping length, max.	7,5
Length	135
Weight	110
POF: polymer optical fibre	



Cable tie tools

RT 1

WSM Tool



For plastic cable ties with widths of 2.5...4.8 mm and a thickness of up to 1.6 mm.

- Tensioning and separating of cable ties in one step
- The tensioning force can be adjusted over a wide range to cover small to standard cable ties.
- For cable bundles of 1.6 mm to 100 mm diameter

For steel cable ties with a width of 4.6 mm

- Tensioning and automatic separation of projecting cable ties in one step
- For steel cable ties, e.g., Weidsteel from Weidmüller



Technical data

Length	mm
Weight	g
Note	

KABELBINDERZANGE RT-1		
Length	mm	160
Weight	g	260
Note		

WSM TOOL AUTOMATIK		
Length	mm	275
Weight	g	579
Note		

Ordering data

Version
Note

Type	Qty.	Order No.
KABELBINDERZANGE RT-1	1	1296000000
Note		

Type	Qty.	Order No.
WSM TOOL AUTOMATIK	1	1774470000
Note		

## Cable tie tools

## Cable tie tools

## WSM Tool



For steel cable ties, 4.6 mm wide

- For pulling the steel cable ties tight; afterwards the cable tie can be removed by turning it 90°.



## Technical data

Length	mm
Weight	g
Note	

WSM TOOL MANUELL		
220		
633		
Note		

## Ordering data

Version
Note

Type	Qty.	Order No.
WSM TOOL MANUELL	1	1774480000
Note		

# Pliers

---

<b>Pliers</b>	Introduction	E.2
	VDE-insulated combination pliers	E.3
	VDE-insulated diagonal-cutting pliers	E.4
	VDE-insulated telephone pliers	E.5
	VDE-insulated flat- and round-nose pliers	E.6
	ESD pliers	E.7

---

# Pliers

Working on live systems calls for special safety procedures and special tools that have been specially produced and tested for such applications.

Weidmüller can provide users with a complete range of pliers which comply with national and international testing standards.

All Weidmüller pliers are produced and tested to DIN EN 60900.

Their ergonomic design fits snugly in the hand, resulting in a more natural, non-fatiguing hand position so you don't catch your fingers.

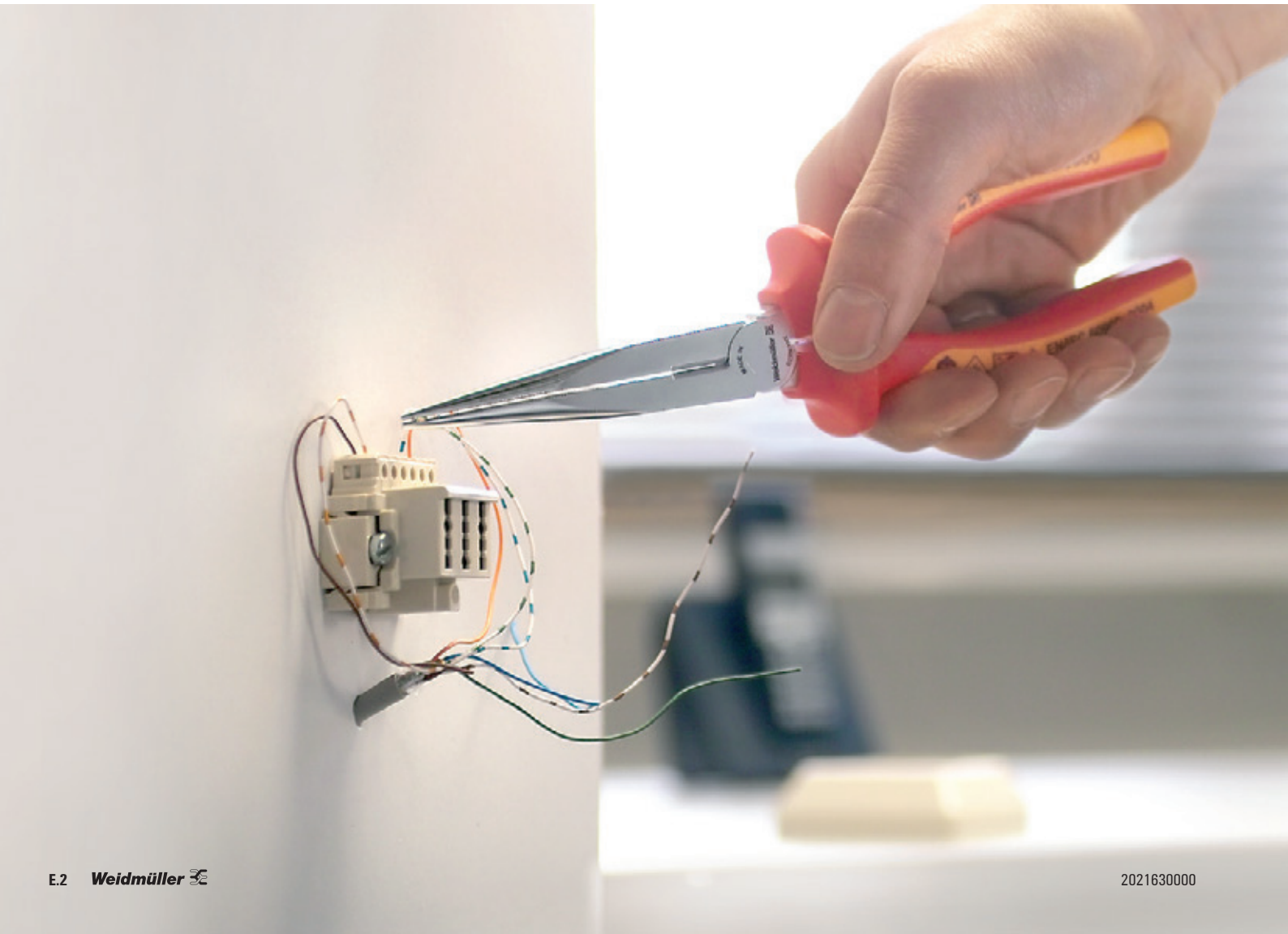

### VDE-insulated combination pliers

Up to 1,000 V (AC) and 1,500 V (DC)

Protective insulation according to IEC 900, DIN EN 60900

- Drop-forged from high-quality special tool steels
- Safety handles with ergonomic and non-slip TPE VDE sleeve
- Made from shockproof, heat and cold resistant, non-flammable, cadmium-free TPE (thermoplastic elastomer)
- Elastic grip zone and hard core
- Highly-polished surface
- Electro-galvanised coating (nickel-chromium) protects against corrosion

### KBZ 160 / KBZ 180 / KBZ 200

Combination pliers



### KBZI 200

Heavy-duty combination pliers (telephone pliers)



#### Combination pliers acc. to DIN ISO 5746

- With opening gap (see diagram)
- Films and metal sheets up to a thickness of 2.5 mm are gripped with the tip
- Up to a thickness of 2.5 mm, the gripping force pulls the workpiece towards the joint
- Extra-long cutter for ribbon and round cables
- For cutting soft and hard wires
- Cutting edges inductively hardened to approx. 60 HRC

#### Telegraph pliers (combination pliers) acc. to DIN 5746

- Heavy-duty model for demanding requirements
- Extra-long cutter for ribbon and round cables
- For cutting soft and hard wires
- Cutting edges inductively hardened to approx. 60 HRC

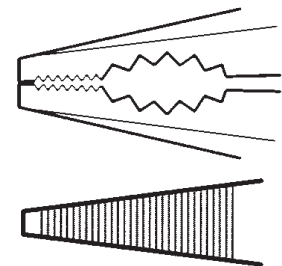
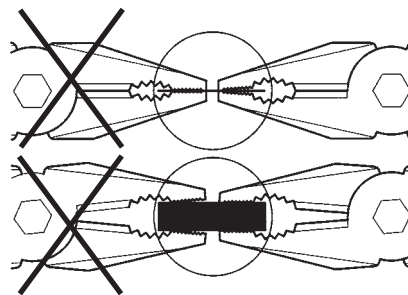

#### Technical data

Cutting performance	
Conductor diameter, max. (H)	mm
Conductor diameter, max. (MH)	mm
Tool data	
Cutter hardness	-
Total length	mm
Weight	g
Note	

KBZ 160	KBZ 180	KBZ 200
1.8	2.5	2.5
2.5	2.8	3
60	60	60
160	180	200
230	290	362
(MH) medium-hard wire; (H) hard wire; (P) piano wire		

KBZI 200
2.5
3
60
200
412
(MH) medium-hard wire; (H) hard wire; (P) piano wire

#### Ordering data

Version
Note

Type	Qty.	Order No.
KBZ 160	1	9046280000
KBZ 180	1	9046290000
KBZ 200	1	9046300000

Type	Qty.	Order No.
KBZI 200	1	9046430000

## VDE-insulated diagonal-cutting pliers

### VDE-insulated diagonal-cutting pliers

Up to 1,000 V (AC) and 1,500 V (DC)

Protective insulation according to IEC 900, DIN EN 60900

- Drop-forged from high-quality special tool steels
- Safety handles with ergonomic and non-slip TPE VDE sleeve
- Made from shockproof, heat and cold resistant, non-flammable, cadmium-free TPE (thermoplastic elastomer)
- Elastic grip zone and hard core
- Highly-polished surface
- Electro-galvanised coating (nickel-chromium) protects against corrosion

### KSE 160 / KSE 200 / SE TOP

Professional diagonal-cutting pliers for piano wire



#### Diagonal-cutting pliers acc. to DIN ISO 5749

- Cutting edges inductively hardened to approx. 64 HRC
- For cutting soft wires and piano wire

#### KSE 160 - KSE 200

- Optimised transmission of force
- Optimised precision cutting edge

#### SE TOP

- With inlaid joint
- Extra-fine precision cutting edge

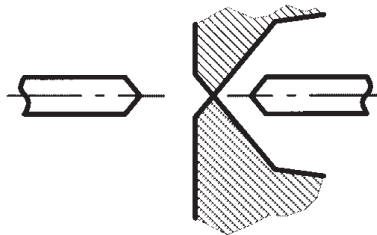

### SE HD 140 / SE HD 160 / SE HD 180

Diagonal-cutting pliers for hard wire



#### Diagonal-cutting pliers acc. to DIN ISO 5749

- With inlaid joint
- With precision cutting edges
- Cutting edges inductively hardened to approx. 62 HRC
- Special tool for steel

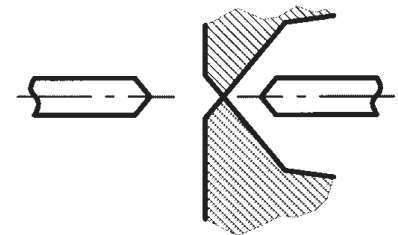

### Technical data

Cutting performance	
Conductor diameter, max. (H)	mm
Conductor diameter, max. (MH)	mm
Conductor diameter, max. (P)	mm
Tool data	
Cutter hardness	-
Total length	mm
Weight	g
Note	

KSE 160	KSE 200	SE TOP
2.5	3	2.5
3.5	4.2	3.5
2	2.5	2
Tool data		
64	64	64
160	200	160
243	325	251
Note		
(MH) medium-hard wire; (H) hard wire; (P) piano wire		

SE HD 140	SE HD 160	SE HD 180
2	2.3	3
2.8	3	3.8
1.4	1.6	1.8
Tool data		
62	62	62
140	160	180
203	253	291
Note		
(MH) medium-hard wire; (H) hard wire; (P) piano wire		

### Ordering data

Version
Note

Type	Qty.	Order No.
KSE 160	1	9046410000
KSE 200	1	9046420000
SE TOP	1	9046340000

Type	Qty.	Order No.
SE HD 140	1	9046310000
SE HD 160	1	9046320000
SE HD 180	1	9046330000

**VDE-insulated telephone pliers**

Up to 1,000 V (AC) and 1,500 V (DC)

Protective insulation according to IEC 900, DIN EN 60900

- Drop-forged from high-quality special tool steels
- Safety handles with ergonomic and non-slip TPE VDE sleeve
- Made from shockproof, heat and cold resistant, non-flammable, cadmium-free TPE (thermoplastic elastomer)
- Elastic grip zone and hard core
- Highly-polished surface
- Electro-galvanised coating (nickel-chromium) protects against corrosion

**FRZ SG 160 / FRZ SG 200**

Half-round-nose pliers with cutter (telephone pliers)



**FRZ S 160 / FRZ S 200**

Half-round-nose pliers with cutter (telephone pliers)



**Bent telephone pliers with cutter**

acc. to DIN ISO 5745 • Half-rounded jaws

- Serrated gripping surfaces
- Tip bent at 45°
- Cutting edges inductively hardened to approx. 60 HRC
- Special tool for steel

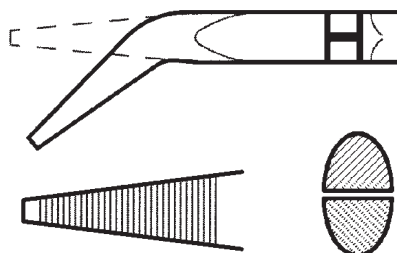

**Telephone pliers with cutter**

acc. to DIN ISO 5745

- Half-rounded jaws
- Serrated gripping surfaces
- Cutting edges inductively hardened to approx. 60 HRC
- Special tool steel

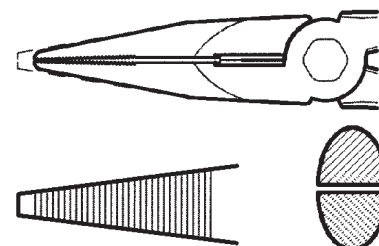

**Technical data**

Cutting performance	
Conductor diameter, max. (H)	mm
Conductor diameter, max. (MH)	mm
Tool data	
Cutter hardness	-
Total length	mm
Weight	g
<b>Note</b>	

FRZ SG 160	FRZ SG 200
1.6	1.8
2.5	2.8
60	60
160	200
162	207
(MH) medium-hard wire; (H) hard wire; (P) piano wire	

FRZ S 160	FRZ S 200
1.6	1.8
2.5	2.8
60	60
160	200
170	224
(MH) medium-hard wire; (H) hard wire; (P) piano wire	

**Ordering data**

Version
<b>Note</b>

Type	Qty.	Order No.
FRZ SG 160	1	9046390000
FRZ SG 200	1	9046400000

Type	Qty.	Order No.
FRZ S 160	1	9046370000
FRZ S 200	1	9046380000



VDE-insulated flat- and round-nose pliers

VDE-insulated flat- and round-nose pliers

Up to 1,000 V (AC) and 1,500 V (DC)

Protective insulation according to IEC 900, DIN EN 60900

- Drop-forged from high-quality special tool steels
- Safety handles with ergonomic and non-slip TPE VDE sleeve
- Made from shockproof, heat and cold resistant, non-flammable, cadmium-free TPE (thermoplastic elastomer)
- Elastic grip zone and hard core
- Highly-polished surface
- Electro-galvanised coating (nickel-chromium) protects against corrosion

FZ 160

Flat-nose pliers



Flat-nose pliers acc. to DIN ISO 5745

- Serrated gripping surface
- With long jaw

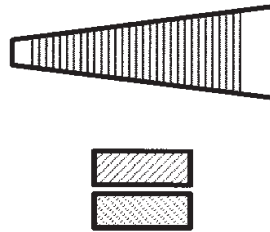

RZ 160

Round-nose pliers



Round-nose pliers acc. to DIN ISO 5745

- Serrated gripping surface
- With long jaw

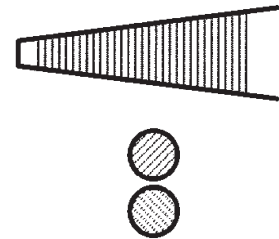

Technical data

Tool data	
Total length	mm
Weight	g
Note	

160
163

160
153

Ordering data

Version
Note

Type	Qty.	Order No.
FZ 160	1	9046350000
Note		

Type	Qty.	Order No.
RZ 160	1	9046360000
Note		

## ESD pliers

Weidmüller ESD pliers can be used with precision and safety when working with sensitive electronics. Electrostatic charging is prevented by the special material on the handle.

Electrostatic discharges (ESD) present a danger to electronics that should not be underestimated. The transferral or discharge of an electrostatic charge can cause significant damage. Charges smaller than 100 volts can cause damage to sensitive components. However, ESD with voltages under 2,000 volts can not be felt by humans. When working with components which are particularly sensitive to electrostatic discharges therefore, you need an electrostatic-free work environment and the properly designed tools.

The ESD pliers are particularly suited for use with electronics, including electronic switches and components, as well as with precision mechanics. All pliers feature an ESD-protected, two-coloured, double-component plastic hand grip. The grip material complied with all of the requirements for ESD hand-tool protection for working with ESD-sensitive components.

The 120 mm-long ESD pliers are available individually or as part of a four-piece set: diagonal-cutting pliers, angle-cutting pliers, with pointed head, flat-nose pliers and snipe-nosed pliers. ESD pliers are not appropriate for working with live components or component assemblies.



## ESD pliers

**SEE ESD 120**

**Electronic ESD diagonal-cutting pliers with pointed head**

- Hard wire (spring wire or steel nails): 0.4 mm/AWG 26
- Semi-hard wire (iron or nails): 1.0 mm/AWG 18
- Soft wire (copper or aluminium): 1.5 mm/AWG 15

**Ordering data**

Type	Qty.	Order No.
SEE ESD 120	1	9205130000

**Technical data**

Weight	90 g
--------	------

**SEE ESD 125**

**Electronic ESD diagonal-cutting pliers with oval head**

- Semi-hard wire (iron or nails): 0.8 mm/AWG 20
- Soft wire (copper or aluminium): 1.5 mm/AWG 15

**Ordering data**

Type	Qty.	Order No.
SEE ESD 125	1	9204750000

**Technical data**

Weight	90 g
--------	------

**FZE ESD 130**

**Electronic ESD flat-nosed pliers**

**Ordering data**

Type	Qty.	Order No.
FZE ESD 130	1	9204760000

**Technical data**

Weight	90 g
--------	------

**SZE ESD 130**

**Electronic ESD Snipe-nosed pliers**

**Ordering data**

Type	Qty.	Order No.
SZE ESD 130	1	9204770000

**Technical data**

Weight	90 g
--------	------

**SVSE ESD 130**

**Electronic ESD angle-cutting pliers**

- Hard wire (spring wire or steel nails): 0.6 mm/AWG 22
- Semi-hard wire (iron or nails): 1.0 mm/AWG 18
- Soft wire (copper or aluminium): 1.2 mm/AWG 16

**Ordering data**

Type	Qty.	Order No.
SVSE ESD 130	1	9205140000

**Technical data**

Weight	90 g
--------	------



**SUPER CUT****Electronic diagonal-cutting pliers**

- Soft wire (copper): 1.2 mm/AWG 16

**Ordering data**

Type	Qty.	Order No.
SUPER CUT	1	9205150000

**KOF SET ESD****Electronic ESD case set**

Contents:

- Diagonal-cutting pliers
- Snipe-nosed pliers
- Flat-nose pliers
- Angle-cutting pliers

**Ordering data**

Type	Qty.	Order No.
KOF SET ESD	1	9205210000





# Screwdrivers

<b>Screwdrivers</b>	Introduction - Screwdrivers	F.2
	Introduction - Electric screwdrivers	F.4
	Torque screwdriver with rechargeable battery	F.6
	Bits	F.8
	Introduction - Torque screwdrivers	F.10
	Uninsulated torque screwdriver	F.11
	VDE-insulated torque screwdriver	F.12
	Special tools SAI	F.14
	Cable gland tools	F.16
	Screwdriver with cutting adapter	F.17
	Introduction - SlimLine screwdriver	F.18
	Introduction - Screwdrivers	F.20
	VDE-insulated screwdriver	F.21
	Uninsulated screwdriver	F.23
	Weidmüller wrench set	F.25
	Pin and electrical cabinet key	F.28



# Screwdrivers

Precisely the proper torque! It's indispensable when you require your work to be precise, effective and repeatable: for example when screwing in sensitive or expensive components, during assembly, final testing, or during quality inspection. This is the ideal job for Weidmüller's manual torque screwdriver with its ergonomic grip and its unique interchangeable bit system.

The Weidmüller screwdriver assortment is the perfect solution; it features the ergonomic design and versatility required for demanding professional applications. Weidmüller safeguards your safety, health, comfort and efficiency with our ergonomic design.

In order to establish secure manual screw connections, all Weidmüller screwdrivers and manual torque screwdrivers feature an advanced geometry, slip protection and a special SoftFinish® area. These qualities enable optimal handling and ensure electrical safety and hand protection even when working on the most critical and potentially dangerous applications.

Weidmüller offers a wide variety of electric screwdrivers, standard bits and innovative quick-change holders – the perfect additions to the manual torque screwdriver. They are the ideal tool for achieving a high level of repetitive accuracy, which is made possible through their ergonomic design and integrated automatic torque control which comes as standard.

Weidmüller also offers innovative solutions for special applications such as cable glands or the fastening of sensor cables.







# Electric screwdrivers

Crimped conductors can be fastened in their corresponding connecting spaces either by the direct plug-in technique or by means of screws.

## Electric screwdrivers / Weidmüller bits

Weidmüller **screwdrivers** are ideal for use with one hand due to their ergonomic design. They guarantee fatigue-free working whatever direction they are being used in, with an automatic torque limit and high repetition accuracy.

The Weidmüller **bits** are standard, of high quality, with a wide range to choose from and all delivering superior performance. We use processor-controlled hardening processes which guarantee consistently high product quality.

The high-grade material enables torques far above those stipulated in the relevant DIN standards:

- DIN 5261 for PH/PZ bits
- DIN 5263 for slotted bits
- Camcar standard for Torx® bits

This means long service life at high torques, producing ideal conditions for standard work.

## Product benefits

- Suitable for all screw driving tasks
- Ideal for both manual and machine screw driving tasks due to the high hardness values of 59 – 61 HRC
- Good wear resistance and therefore a long service life
- Optimum fit in DIN screws for low wear and optimum torque transmission
- Manufactured with consistently high product quality based on the relevant ISO standards



**Easy handling**

The DMS Pro, with its 500 g and the non-slip rubber handle, fits snugly and securely in your hand. This means you work ergonomically and prevent rapid fatigue.



**Consistent torque**

Thanks to the electronic shut-off, the DMS Pro turns off when the set torque is reached. You are therefore assured that every screw is connected with the same torque even if the battery is nearly flat.



**Illuminated screwing point**

The LED work light illuminates the work area of the DMS Pro and helps you to find screws faster and easier in dark areas.

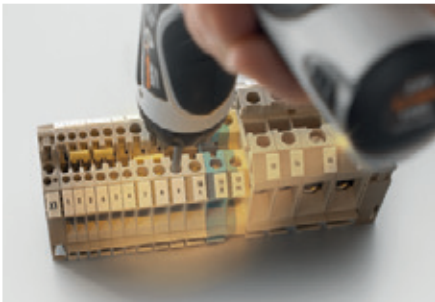

## Torque screwdriver with rechargeable battery

## Cordless torque screwdriver

- One-hand operation under all working conditions
- Clockwise/anticlockwise rotation
- Two speeds: 200 and 600 min<sup>-1</sup>
- Precise torque pre-selection in 21 steps
- High repeat accuracy
- Switch easily from straight to pistol grip
- Bit holder: 1/4" ball-bearing fixing mechanism (Form E6.3)
- Transport lock prevents accidental operation
- Simple switchover from battery to manual operation up to approx. 15 Nm
- LED work light
- Electronic shut-off clutch
- 1.5 Ah Li-Ion battery technology
- Ergonomic handle design

## DMS PRO



## DMS PRO SET



## Technical data

Screwdriver	
Rated voltage	3.6 V
Idling speed	200 u. 600 min <sup>-1</sup>
Max. coupling torque	3 Nm
Bit holder	1/4" DIN 3126 Form E6.3
Length	276 mm
Weight	500 g
Battery	
Rechargeable batteries	Li-Ion battery
Battery voltage	3.6 V
Charger	
Charger input	AC 220-240V~50-60Hz 30W
Charger output	DC 2.8...6V; 4.8A / 30W max.
Charging time	30 min
Weight	500 g
Note	

## Ordering data

Version			
Type	Qty.	Order No.	
DMS PRO	1	1479120000*	
Note			

## Accessories

Accessories			
Type	Qty.	Order No.	
AKKU DMS PRO	1	1479110000	
LG DMS PRO/ DMS 3	1	9007460000	
Note			

LOW 200/min HIGH 600/min			
Lev	Nm	Lev	Nm
01	0.36	11	1.45
02	0.46	12	1.55
03	0.57	13	1.67
04	0.66	14	1.78
05	0.80	15	1.99
06	0.87	16	2.14
07	0.98	17	2.26
08	1.10	18	2.41
09	1.20	19	2.53
10	1.36	20	2.67
		21	2.83

Typ	VPE	Best.-Nr.
DMS PRO SET (screwdriver incl. batterie, 1 additional battery, charger, bits, plastic carrying case)**	1	1479090000*

\* available in Europe

\*\* see picture

**Torque screwdriver with rechargeable battery**

- One-hand operation under all working conditions
- Clockwise/anticlockwise
- Two speeds: 200 and 400 rpm<sup>1</sup>
- Precise torque pre-selection of approx. 0.3...3 Nm in 6 steps
- High reproducibility right up to complete discharge of the rechargeable battery
- Simple changeover from straight to pistol form
- Bit holder: 1/4" ball bearing fixing mechanism (form E6.3)
- Safety lock prevents unintentional activation
- Simple switchover from battery to manual operation up to 15 Nm

**DMS 3****DMS 3 Set****Technical data**

Screwdriver	
Rated voltage	2.4 V
Idling speed	200 u. 400 min <sup>-1</sup>
Torque setting, max.	3 Nm
Bit holder	1/4" DIN 3126 Form E6.3
Length	239
Weight	400
Battery	
Rechargeable batteries	Ni-Mh cells
Weight of rechargeable battery	122 g
Charger	
Charger input	230 V AC; 50 Hz; 50 mA
Charger output	2.9 V AC; 1.4 A; 4.1 VA
Charging time	45 min
Weight of charger	700 g
<b>Note</b>	

**Ordering data**

Version	Type	Qty.	Order No.
	DMS 3	1	9007440000
	DMS 3 ZERT	1	9017870000
<b>Note</b>	Incl. rechargeable battery		

**Accessories**

Type	Qty.	Order No.
AKKU DMS 3	1	9007450000
LG DMS PRO/ DMS 3	1	9007460000
<b>Note</b>		

level	ca. Nm LOW	ca. Nm HIGH	level	ca. Nm LOW	ca. Nm HIGH
1	0.3	0.45	4	1.0	1.15
1.1	0.35	0.5	4.1	1.1	1.25
1.2	0.45	0.6	4.2	1.2	1.3
1.3	0.5	0.65	4.3	1.3	1.4
2	0.55	0.7	5	1.35	1.45
2.1	0.6	0.75	5.1	1.45	1.5
2.2	0.65	0.8	5.2	1.5	1.6
2.3	0.7	0.85	5.3	1.6	1.7
3	0.75	0.95	6	2.5	2.5
3.1	0.8	1.0			
3.2	0.85	1.0			
3.3	0.95	1.1			

Type	Qty.	Order No.
DMS 3 set 1 (screwdriver incl. batterie, charger, bits, plastic carrying case)*	1	9007470000
DMS 3 set 2 (as set 1, with 1 additional battery)	1	9007480000
Bit-Box DMS3	1	9024970000
DMS 3 set 1 Zert	1	9017450000
DMS 3 set 2 Zert	1	9017420000

\*) see picture

## Bits

## Bits drive 1/4 E6.3

1/4" hexagon drive, acc. to DIN 3126,  
Shape E6.3 for direct machine connection

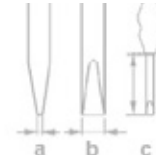

## Bit E6.3 S

Slotted bits DIN 5264,  
1/4" drive E6.3 DIN 3126

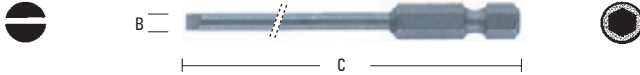

Type	Size / AF	a	b	c	Order No.
BIT E6,3 0,4x2,5x70		0.4	2.5	70	9202750000
BIT E6,3 0,5x3,0x70		0.5	3	70	9024000000
BIT E6,3 0,5x3,0x110		0.5	3	110	9205600000
BIT E6,3 0,6x3,5x70		0.6	3.5	70	9024020000
BIT E6,3 0,6x3,5x110		0.6	3.5	110	9205610000
BIT E6,3 0,6x4,5x110		0.8	4.5	110	9205630000
BIT E6,3 0,8x4,0x70		0.8	4	70	9024030000
BIT E6,3 0,8x4,0x110		0.8	4	110	9205620000
BIT E6,3 1,0x5,5x70		1	5.5	70	9024040000
BIT E6,3 1,0x5,5x110		1	5.5	110	9205640000
BIT E6,3 1,2x6,5x70		1.2	6.5	70	9202740000
BIT E6,3 1,2x6,5x110		1.2	6.5	110	9205650000

## Bit E6.3 PH

Crosshead bits, Phillips-recess type PH/DIN 5260.  
1/4" drive E6.3 DIN 3126

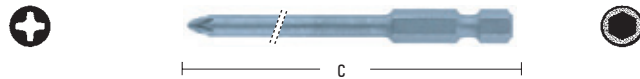

BIT E6,3 PH1x70	1		70	9024080000
BIT E6,3 PH2x70	2		70	9024090000

## Bit E6.3 PZ

Crosshead bits, Pozidrive type PZ/DIN 5262,  
1/4" drive E 6.3 DIN 3126

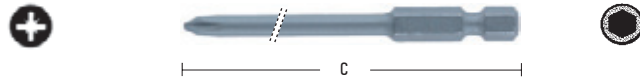

BIT E6,3 PZ1x70	1		70	9024100000
BIT E6,3 PZ2x70	2		70	9024110000

## Bit E6.3 Z

Slotted bits with pilot tip DIN 5264,  
1/4" drive E6.3 DIN 3126



BIT E6,3Z 0,6x3,5x70	0.6	3.5	70	9205670000
BIT E6,3Z 0,8x4,0x70	0.8	4	70	9205660000

## Bit E6.3 T

Torx® bits,  
drive 1/4" E6.3 DIN 3126



BIT E6,3 T15				1318350000
BIT E6,3 T20				1318370000
BIT E6,3 T40				1318380000



**Bits drive 1/4 E6.3**

1/4" hexagon drive, acc. to DIN 3126, shape E6.3 for direct machine connection (DMS2 1/4" E6.3)

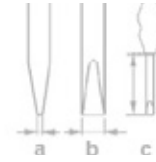

**Bit box DMS3**

Weidmüller bit box, 9-piece, fitted with universal holder 1/4" drive E6.3 DIN 3126; drive: 1/4" E6.3; 1/4" bits C6.3



Type	Size / AF	a	b	c	Order No.
UBH 1/4" E6.3					
BIT C6,3 0,5x4,0x25		0.5	4	25	
BIT C6,3 0,6x4,5x25		0.6	4.5	25	
BIT C6,3 PH0x25				25	
BIT C6,3 PH1x25				25	
BIT C6,3 PH2x25				25	
BIT C6,3 PZ0x25				25	
BIT C6,3 PZ1x25				25	
BIT C6,3 PZ2x25				25	
Bit-Box WI DMS 3					9024970000

**UBH 1/4 E6.3**

Short universal bit holder, magnetic drive: 1/4" E6.3 DIN 3126, output: 1/4" E6.3



UBH 1/4 E6,3	9009520000
--------------	------------

**UBH SWH 1/4 EC 6.3**

Universal quick-change holder with locking function. True one-hand operation for quick bit changes. Drive: 1/4" E6.3 DIN 3126, output: 1/4" E6.3 + C6.3 double bits



UBH SWH 1/4 EC 6.3	9205680000
--------------------	------------

**BHS 1/4**

Bit holder with flexible shank for reaching awkward screws, for all bits, output drive: 1/4" C6.3 DIN 3126 with SoftFinish® grip



BHS 1/4	9009630000
---------	------------



## DMS manual / DMSI manual

### Torque screwdrivers with insulation up to 1,000 V (VDE) DMSI manual

The „DMSI manual“ with an integral window scale, combined with a Weidmüller 1,000 V insulated (VDE) interchangeable blade, ensures controlled tightening of screws and maximum reliability in electrical applications.

Every 1,000 V insulated (VDE) handle and blade is tested and provides the necessary safety up to 1,000 V AC / 1,500 V DC.



1000 V  
EN 60900

Scale

### Torque screwdrivers DMS manual

This is a versatile tool suitable for a variety of jobs, with an integral scale for easy reading of the torque value and a Weidmüller interchangeable blade.



### Each model is available with two torque ranges:

- 0.5 to 1.7 Nm
- 2.0 to 8.0 Nm
- setting tool included

### Advantages:

- Compact and especially lightweight design
- Torque set with special tool (included) to ensure the right setting
- Ergonomic handle size to match the torque range
- Every tool checked and given an ID No., 100 % quality control with verification and product reference
- Audible, unmistakable click upon reaching the torque, no unnecessary effort
- Interchangeable blade made from high-quality wear-resistant tool steel
- All tools comply with the accuracy stipulations of: EN ISO 6798, BS EN 26789, ASME B107.14M
- Operating accuracy:  $\pm 6$  % of set scale value



Setting tool

Uninsulated torque screwdrivers

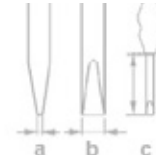

**DMS manual**

Torque screwdriver  
EN ISO 6798, BS EN 26789, ASME B107.14M



Type	Size / AF	a	b	c	Order No.
DMS MANUELL 0,5-1,7	0.5 - 1.7 Nm				9918370000
DMS MANUELL 2,0-8,0	2.0 - 8.0 Nm				9918380000

**WK K S**

Interchangeable bits for torque screwdrivers  
Drive output acc. to DIN 5264, ISO 2380/1



WK S 0,4x2,5	max. 0.4 Nm	0.4	2.5	175	9918520000
WK S 0,5x3,0	Max. 0.6 Nm	0.5	3	175	9918530000
WK S 0,6x3,5	Max. 1.1 Nm	0.6	3.5	175	9918540000
WK S 0,8x4,0	Max. 2.5 Nm	0.8	4	175	9918550000
WK S 1,0x5,5	Max. 3.8 Nm	1	5.5	175	9918560000

**WK K PZ**

Interchangeable bits for torque screwdrivers  
Drive output acc. to DIN 5260-PZ, ISO 8764/1-PZ



WK K PZ0	Max. 9 Nm			175	9918600000
WK K PZ1	Max. 3.8 Nm			175	9918610000
WK K PZ2	Max. 5.5 Nm			175	9918620000

**WK K PH**

Interchangeable bits for torque screwdrivers  
Drive output acc. to DIN 5260-PH, ISO 8764/1-PH



WK K PH0	Max. 9 Nm			175	9918570000
WK K PH1	Max. 3.8 Nm			175	9918580000
WK K PH2	Max. 5.5 Nm			175	9918590000

**WGK 1/4 C6.3 E6.3**

Interchangeable bit with bit holder for torque screwdrivers  
Drive output: 1/4" C6.3 and 1/4" E6.3



WK 1/4 C6,3 E6,3					9202510000
------------------	--	--	--	--	------------

## VDE-insulated torque screwdrivers

## VDE-insulated torque screwdrivers



## DMSI manual

VDE-insulated torque screwdriver  
EN ISO 6798, BS EN 26789, ASME B107.14M



Type	Size / AF	a	b	c	Order No.
DMSI MANUELL 0,5-1,7	0.5 - 1.7 Nm				9918390000
DMSI MANUELL 2,0-8,0	2.0 - 8.0 Nm				9918400000

## WK SI

VDE-insulated interchangeable bits for VDE-insulated torque screwdriver; drive output acc. to DIN 5264, ISO 2380/1



WK SI 0,4x2,5	max. 0.4 Nm	0.4	2.5	200	9918410000
WK SI 0,5x3,0	Max. 0.6 Nm	0.5	3	200	9918420000
WK SI 0,6x3,5	Max. 1.1 Nm	0.6	3.5	200	9918430000
WK SI 0,8x4,0	Max. 2.5 Nm	0.8	4	200	9918440000
WK SI 1,0x5,5	Max. 3.8 Nm	1	5.5	200	9918450000

## WK IK PH

VDE-insulated interchangeable bits for VDE-insulated torque screwdriver; drive output acc. to DIN 5260-PH, ISO 8764/1-PH



WK IK PH0	Max. 9 Nm			200	9918460000
WK IK PH1	Max. 3.8 Nm			200	9918470000
WK IK PH2	Max. 5.5 Nm			200	9918480000

## WK IK PZ



WK IK PZ0	Max. 9 Nm			200	9918490000
WK IK PZ1	Max. 3.8 Nm			200	9918500000
WK IK PZ2	Max. 5.5 Nm			200	9918510000

## WK IK SL/PH

VDE-insulated interchangeable bits for VDE-insulated torque screwdriver



WK IK SL/PH1	Max. 3.8 Nm				1318130000
WK IK SL/PH2	Max. 5.5 Nm				1318140000





**The Torque Screwty®**

- Easier work
- Screw-on circular plug, safety sealed

**The perfect tool for all situations**

Screwty® is the ideal, universal tool for tightening and releasing cable glands on all common sensor and actuator cables. The Screwty® can also reach those round plugs normally considered inaccessible! No great force is required – simply turn the tool to tighten or release the plug-in connector as required. The Screwty® also fits the majority (more than 90 %) of the cables and plug-in connectors of other suppliers and is therefore a unique tool useful throughout the world. The Screwty® consists of a handle with a conventional 1/4" fitting. This means it can be used for all sizes: for M12 and M8 round plugs, and the M12F and M8F types, also for plugs and sockets on custom cables.

The Screwty® is suitable for the following round plugs:

Size	M8	M8F	M12	M12F
	10 ±0,3 mm	11,9 ±0,3 mm	14,5 ±0,3 mm	19,8 ±0,3 mm
Thread	M8x1	M8x1	M12x1	M12x1

An adjustable torque fitting is also available for the Screwty® – for guaranteeing extra reliability during installation.

The torque can be infinitely adjusted between 0.5 and 1.7 Nm. This accurate setting enables all round plugs to be tightened precisely with a certain torque.

Weidmüller specifies the following torques for its round plugs:

Size	M8	M8F	M12	M12F
Torque	0,5-0,6 Nm	0,5-0,6 Nm	0,8-1,2 Nm	0,8-1,2 Nm
Thread	M8x1	M8x1	M12x1	M12x1

The Screwty® can also be fitted with other blades to create a torque screwdriver.

F

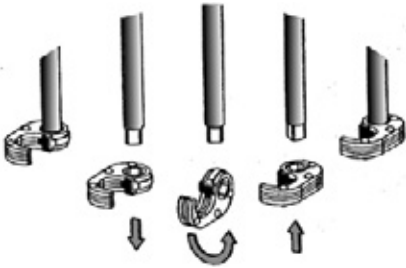

**Simply turn the ratchet to tighten or loosen the cable gland.**



**Use of a M12 Screwty®**

1. Position Screwty®
2. Tighten connector
3. Finished!



**Use of a M23 Screwty®**

### Screwty® standard



#### Ordering data

Type	Use	Qty.	Order No.
Screwty® M12	moulded M12 lines	1	1900000000
Screwty® M8	moulded M8 lines	1	1900010000
Screwty® M12 F	M12 plugs for custom assembly	1	1900020000
Screwty® M8 F	M8 plugs for custom assembly	1	1900030000

### Screwty® Set



#### Ordering data

Type	Qty.	Order No.
Screwty® Set	1	1910000000

Type	Contents
Screwty® Set	1x Screwty® standard handle + 1 M12, M8, M12 F, M8 F attachments

### Screwty® attachments



Screwty® M8 attachment

Screwty® M8 F attachment

Screwty® M12 attachment

Screwty® M12 F attachment

Screwty® M23 attachment

#### Ordering data

Type	Qty.	Order No.
Screwty® M12 KO o. SD	1	1900100000
Screwty® M8 KO o. SD	1	1900110000
Screwty® M12F KO o. SD	1	1900120000
Screwty® M8F KO o. SD	1	1900130000
Screwty® M23 LS	1	1981560000

#### Legend:

F	for custom assemblies
DM	torque
KO o. SD	ratchet only (attachment)
Screwty®	screwdriver
Screwty® DM	torque screwdriver, interchangeable blade
WK	interchangeable blade
LS	power plug

### Screwty® with torque fitting

Setting aid for Screwty® with torque fitting (included)



#### Ordering data

Type	Use	Qty.	Order No.
Screwty®-M12-DM	moulded M12 lines with torque requirement	1	1900001000
Screwty®-M8-DM	moulded M8 lines with torque requirement	1	1900011000
Screwty®-M12 F-DM	M12 plugs, custom assembly with torque requirement	1	1900021000
Screwty®-M8 F-DM	M8 plugs, custom assembly with torque requirement	1	1900031000

Type	Contents
Screwty®-M12-DM	1 interchangeable blade, 1 torque handle, 1 setting aid for Screwty® torque, 1 Screwty® M12 attachment
Screwty®-M8-DM	1 interchangeable blade, 1 torque handle, 1 setting aid for Screwty® torque, 1 Screwty® M18 attachment
Screwty®-M12 F-DM	1 interchangeable blade, 1 torque handle, 1 setting aid for Screwty® torque, 1 Screwty® M12 F attachment
Screwty®-M8 F-DM	1 interchangeable blade, 1 torque handle, 1 setting aid for Screwty® torque, 1 Screwty® M18 F attachment

### Screwty® Set-DM



#### Ordering data

Type	Qty.	Order No.
Screwty® Set-DM	1	1920000000

Type	Contents
Screwty® Set-DM	1 interchangeable blade, 1 torque handle, 1 setting aid for Screwty® torque, 1 each of Screwty® M12, M8, M12 F, M8 F attachments

### Screwty® interchangeable handle/interchangeable bit



#### Ordering data

Type	Use	Qty.	Order No.
1/4" handle		1	4294820000
WK-1/4" (Screwty®)		1	1862200000

## Cable gland tools

## Cable gland tools

Screwing tool for all types of cable glands.

- Can tighten or loosen several rows of cable glands
- No deforming of the cable glands

## FleCaFix 11/24

Cable gland tool



- Spanner size: 11 to 24 AF
- Infinite adjustment of spanner size
- Ratchet function: not necessary to remove tool between turns
- Authentic one-hand tool

## FleCaFix 24/36

Cable gland tool



- Spanner size: 24 to 36 AF
- Infinite adjustment of spanner size
- Ratchet function: not necessary to remove tool between turns
- Authentic one-hand tool



## Technical data

Tool data	
Length / Width / Height	mm
Weight	g
AF size	-
Note	

Length / Width / Height	190 / 30 / 60
Weight	190
AF size	11 - 24mm
Note	

Length / Width / Height	204 / 30 / 60
Weight	240
AF size	24 - 36 mm
Note	

## Ordering data

Version
Note

Type	Qty.	Order No.
FLECAFIX 11/24	1	9015900000
Note		

Type	Qty.	Order No.
FLECAFIX 24/36	1	9015980000
Note		



**Screwdriver with cutting adapter**

For the pinch-free cutting of copper cable.

- Solid up to 1.5 mm<sup>2</sup>
- Flexible up to 2.5 mm<sup>2</sup>

**swifty®****swifty®**

- cable cutter which fits onto uninsulated screwdrivers, with a blade diameter of 3.5 mm
- Minimal hand force required
- Cutter opens automatically
- Ergonomic handle design

**swifty®set**

- Logical operation
- Only one tool for cable processing in IDC technology
- Can be used for screw and tension clamp terminals
- Pocket format - always ready to hand
- Suitable for right- and left-hand use
- One-handed operation

**swifty®set****Technical data**

Max. cutting performance, copper cable		
Copper cable - solid, max.	mm <sup>2</sup>	1.5
Copper cable - flexible, max.	mm <sup>2</sup>	2.5
Tool data		
Length / Width / Height	mm	35 / 18 / 40
Weight	g	20
Note		

**Ordering data**

Version	Type	Qty.	Order No.
Without screwdriver	SWIFTY	1	9006020000
Note			

Typ	VPE	Order No.
swifty®set (with screwdriver)	1	9006060000
Screwdriver (SD 0,6 3,5x100)	1	9008330000
Note		

## SlimLine screwdriver

### VDE insulated screwdriver with thin blade

The SlimLine screwdriver design allows you to reach deeply inset fittings and tension clamp terminals which cannot normally be reached using a standard VDE screwdriver. The SlimLine screwdrivers can be used for Weidmüller's Z-series of terminal blocks. The tools have an ergonomically designed grip so that they can be used without causing pain or stress. The SoftFinish® zone delivers excellent feel, ensures electrical safety and is easy on your hands.

#### A blade that is up to 33 % thinner

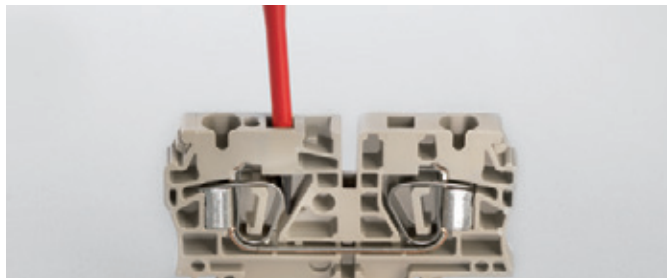

The moulded protective insulation, applied directly to the shaft ensures safety and protection during critical applications at levels of up to 1,500 V (DC) or 1,000 V (AC).

#### Ergonomic design



The ergonomic grip design makes for a comfortable screwing process and excellent handling. The SoftFinish® zone prevents the tool from slipping away and thus makes higher torques possible.



#### Security



The moulded protective insulation, applied directly to the shaft ensures safety and protection during critical applications at levels of up to 1,500 V (DC) or 1,000 V (AC).

**SlimLine screwdriver insulated acc. to VDE specs**

VDE-insulated screwdriver, for working on live parts up to 1,000 V AC and 1,500 V DC. DIN EN 60900, IEC 900, Safety tested „GS“, each piece tested. The bit is made from fully-hardened, high-alloy, chromium-vanadium-molybdenum steel with a gun-metal finish.

**A blade that is up to 33 % thinner**

The SlimLine design allows you to reach deeply inset fittings and tension clamp terminals.

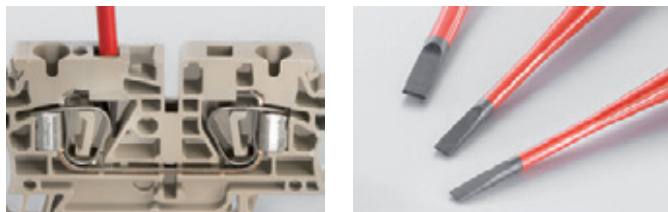

**SDI SL S**

VDE insulated slot-head screwdriver, SDI SL DIN 7437, ISO 2380/2, drive output acc. to DIN 5264, ISO 2380/1. SoftFinish® grip



**SDIK SL PH**

VDE-insulated crosshead screwdriver, Phillips type, SDIK PH DIN 7438, ISO 8764/2-PH, output acc. to ISO 8764-PH, SoftFinish® grip



**SDIK SL PZ**

VDE-insulated crosshead screwdriver Pozidrive type, SDIK SL PZ DIN 7438, ISO 8764/2-PZ, output acc. to ISO 8764-PZ, SoftFinish® grip



**SDIS SL 2.5-5.5/PH/1/2**

6-part set: VDE insulated slotted and crosshead PH screwdriver set

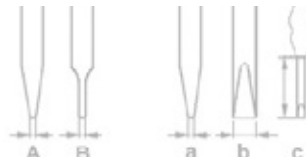

Type	Blade type	Size / AF	a	b	c	Order No.
SDIS SL 0.6X3.5X100			0.6	3.5	100	1274660000
SDIS SL 0.8X4.0X100			0.8	4	100	1274670000
SDIS SL 1.0X5.5X125			1	5.5	125	1274680000
SDIS SL 1.2X6.5X150			1.2	6.5	150	1274690000

SDIK PH1 SL	size PH1	80	1274710000
SDIK PH2 SL	Gr. PH2	100	1274720000

SDIK PZ1 SL	size PZ1	80	1274730000
SDIK PZ2 SL	Gr. PZ2	100	1274740000

SDIS SL 0.6X3.5X100	0.6	3.5	100	
SDIS SL 0.8X4.0X100	0.8	4	100	
SDIS SL 1.0X5.5X125	1	5.5	125	
SDIS SL 1.2X6.5X150	1.2	6.5	150	
SDIK PH1 SL	size PH1	80		
SDIK PH2 SL	Gr. PH2	100		
SDI SL S3.5-6.5/PH1/2				1274750000

# Screwdrivers

Weidmüller screwdrivers come in four different grip sizes, and are the result of a consistent grip concept which takes into account both the human hand and the different work requirements and conditions.

- Perfect handling with all grip sizes
- Maximum torques
- Optimum transmission of axial force
- Complete range including all commercial sizes



## SoftFinish® grip



Weidmüller's SoftFinish® grip zone for use in dry conditions and for general applications offers customers a complete range of screwdrivers that enables far higher torques as well as substantially more comfort due to the soft material of the grip.

### Product benefits:

- Made of an especially soft material, which is kind to the skin, the SoftFinish® zone enables maximum torques
- Perfect ergonomic grip design for comfortable screw driving and optimum handling
- You can choose from long-life extremely stressable blades in standard sizes
- ChromTop blade tip offers maximum corrosion protection and greatest possible dimensional accuracy of the blade geometry in the screw head over many years

## SoftFinish® electric



VDE-insulated screwdriver according to DIN EN 60900, IEC 900 for work on live equipment

### Product benefits:

- The protective insulation moulded directly on the screwdriver blade ensures electrical safety, even in critical applications
- Safe for working at up to 1,500 volts DC and 1,000 volts AC
- Each screwdriver is individually tested in a water bath at 10,000 volts according to DIN EN 60900
- Perfect ergonomic grip design for comfortable screw driving and optimum handling
- Made of special soft material which is kind to the skin, the SoftFinish® zone prevents slipping in critical situations and at the same time enables maximum torques

**VDE-insulated screwdriver**

VDE-insulated screwdriver, for working on live parts up to 1000 VAC and 1500 VDC, DIN EN 60900, IEC 900.

Safety tested „GS“, each piece tested. Bit made from fully hardened, high-alloy chromium-vanadium-molybdenum steel, gun-metal finish.

**SDI S**

Slot-head screwdriver, insulated according to VDE spec., SDI DIN 7437, ISO 2380/2, drive output acc. to DIN 5264, ISO 2380/1, SoftFinish®grip



**SDIK PH**

Phillips, SDIK PH crosshead screwdriver, insulated according to VDE spec. DIN 7438, ISO 8764/2-PH, drive output acc. to ISO 8764-PH, SoftFinish®grip



**SDIK PZ**

Phillips, SDIK PH crosshead screwdriver, insulated according to VDE spec. DIN 7438, ISO 8764/2-PH, drive output acc. to ISO 8764-PH, SoftFinish®grip



**SDI SL / PH**

VDE-insulated plus-minus screwdriver, Phillips, SDI SL/PH SoftFinish®grip



**SDIZ**

Slot-head screwdriver, insulated according to VDE spec., SDI DIN 7437, ISO 2380/2, drive output acc. to DIN 5264, ISO 2380/1, SoftFinish®grip

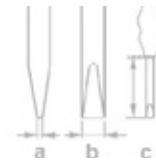

Type	Blade type	Size / AF	a	b	c	Order No.
SDIS 0.4X2.0X60	A		0.4	2	60	9205690000
SDIS 0.4X2.5X75	A		0.4	2.5	75	9008370000
SDIS 0.5X3.0X100	B		0.5	3	100	9008380000
SDIS 0.6X3.5X100	B		0.6	3.5	100	9008390000
SDIS 0.8X4.0X100	B		0.8	4	100	9008400000
SDIS 1.0X4.5X125	B		1	4.5	125	9008910000
SDIS 1.0X4.5X175	B		1	4.5	175	9205700000
SDIS 1.0X5.5X125	B		1	5.5	125	9008410000
SDIS 1.0X5.5X175	B		1	5.5	175	9205710000
SDIS 1.2X6.5X150	B		1.2	6.5	150	9008420000
SDIS 1.6X8.0X175	B		1.6	8	175	9008430000

SDIK PH0	60	9008560000
SDIK PH1	80	9008570000
SDIK PH2	100	9008580000
SDIK PH3	150	9008590000

SDIK PZ1	80	9008900000
SDIK PZ2	100	9008890000

SDI SL/PH 1		1318330000
SDI SL/PH 2	Gr. PZ2	1318340000

SDIZ 0.6X3.5X100	0.6	3.5	100	9008450000
SDIZ 0.8X4.0X100	0.8	4	100	9008460000
SDIZ 0,8X5,5 150/248	0.8	5.5	150	9008640000

## VDE-insulated screwdriver

### VDE-insulated screwdriver

VDE-insulated screwdrivers, for working on live parts up to 1000 VAC and 1500 VDC, DIN EN 60900, IEC 900. Safety tested „GS“, each piece tested. Blade/bit made from fully hardened, high-alloy chromium-vanadium molybdenum steel, gun-metal finish.

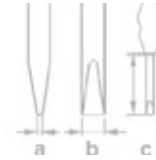

### SDIS 2.5-5.5/PH/1/2

6-part set: VDE insulated slotted and crosshead PH screwdriver set



Type	Blade type	Size / AF	a	b	c	Order No.
SDIS 0.4X2.5X75	A		0.4	2.5	75	
SDIS 0.5X3.0X100	B		0.5	3	100	
SDIS 0.8X4.0X100	B		0.8	4	100	
SDIS 1.0X5.5X125	B		1	5.5	125	
SDIK PH1					80	
SDIK PH2					100	
SDI Set S2.5-5.5/PH1/2						9009730000

### SDIS 2.5-5.5/PZ/1/2



SDIS 0.4X2.5X75	A		0.4	2.5	75	
SDIS 0.5X3.0X100	B		0.5	3	100	
SDIS 0.8X4.0X100	B		0.8	4	100	
SDIS 1.0X5.5X125	B		1	5.5	125	
SDIK PZ1					80	
SDIK PZ2					100	
SDI Set S2.5-5.5/PZ1/2						1128540000

### SDIS 2.0-5.5

6-part set: VDE-insulated slotted screwdriver set



SDIS 0.4X2.0X60	A		0.4	2	60	
SDIS 0.4X2.5X75	A		0.4	2.5	75	
SDIS 0.5X3.0X100	B		0.5	3	100	
SDIS 0.6X3.5X100	B		0.6	3.5	100	
SDIS 0.8X4.0X100	B		0.8	4	100	
SDIS 1.0X5.5X125	B		1	5.5	125	
SDI Set S2.0-5.5						9205550000

**Uninsulated screwdriver**

Weidmüller SoftFinish®screwdriver for general applications. Bit made from fully hardened, high-alloy chromium-vanadium-molybdenum steel, matt-chrome finish.



**SD S**

Slotted screwdriver with rounded blade, SD DIN 5265, ISO 2380/2, drive output acc. to DIN 5264, ISO 2380/1, ChromTop tip, SoftFinish®grip



Type	Blade type	Size / AF	a	b	c	Order No.
SDS 0.4X2.0X60	B		0.4	2	60	9037160000
SDS 0.4X2.5X75	A		0.4	2.5	75	9009030000
SDS 0.5X3.0X80	A		0.5	3	80	9008320000
SDS 0.6X3.5X100	A		0.6	3.5	100	9008330000
SDS 0.6X3.5X200	A		0.6	3.5	200	9010110000
SDS 0.8X4.0X100	A		0.8	4	100	9008340000
SDS 0.8X4.5X125	A		0.8	4.5	125	9009020000
SDS 1.0X5.5X150	A		1	5.5	150	9008350000
SDS 1.2X6.5X150	A		1.2	6.5	150	9009010000

**SDK PH**

Crosshead screwdriver, Phillips, SDK PH DIN 5262, ISO 8764/2-PH, drive output acc. to ISO 8764-PH, chrome top tip, SoftFinish®grip



SDK PH0				3	60	9008470000
SDK PH1				4.5	80	9008480000
SDK PH2				6	100	9008490000
SDK PH3				8	150	9008500000

**SDK PZ**

Crosshead screwdriver, Pozidriv, SDK PZ DIN 5262, ISO 8764/2-PZ, drive output acc. to ISO 8764-PZ, chrome top tip, SoftFinish®grip



SDK PZ1				4.5	80	9008530000
SDK PZ2				6	100	9008540000
SDK PZ3				8	150	9008550000

**SD TH**

Torx® TH screwdriver with hole in tip of blade (tamper-resistant), SD TH for screwing Torx® and Torx®TH security screws (pin in centre of Torx® recess), ChromTop tip, SoftFinish®grip



SD TH10				10	4	80	9009180000
SD TH15				15	4	80	9009170000
SD TH20				20	4	100	9009160000

**SK**

Hexagonal key, SK DIN 3125, drive output acc. to DIN 475/2, SoftFinish®grip



SK 10,0x125							9009070000
-------------	--	--	--	--	--	--	------------



## Uninsulated screwdriver

### Uninsulated screwdriver

Weidmüller SoftFinish®screwdriver for general applications. Bit made from fully hardened, high-alloy chromium-vanadium-molybdenum steel, matt-chrome finish.



#### Set S 2.5/3.0/4.0/5.5/PH 1/2

6-part set: slotted and crosshead PH screwdriver set with circular blades

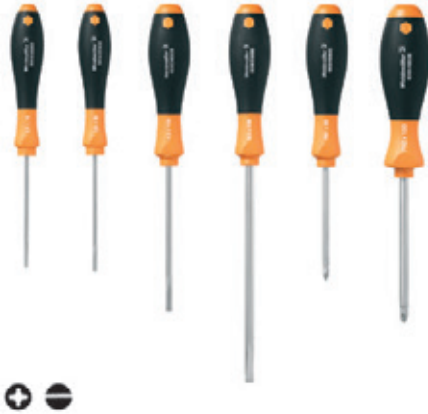

Type	Blade type	Size / AF	a	b	c	Order No.
SDS 0.4X2.5X75	A		0.4	2.5	75	
SDS 0.5X3.0X80	A		0.5	3	80	
SDS 0.8X4.0X100	A		0.8	4	100	
SDS 1.0X5.5X150	A		1	5.5	150	
SDK PH1				4.5	80	
SDK PH2				6	100	
SD Set S2.5-5.5/PH1/2						9009740000

#### Set S 2.0/2.5/3.0/3.5/4.0/5.5

6-part set: slotted screwdriver set



SDS 0.4X2.0X60	B		0.4	2	60	
SDS 0.4X2.5X75	A		0.4	2.5	75	
SDS 0.5X3.0X80	A		0.5	3	80	
SDS 0.6X3.5X100	A		0.6	3.5	100	
SDS 0.8X4.0X100	A		0.8	4	100	
SDS 1.0X5.5X150	A		1	5.5	150	
SD Set S2.0-5.5						9205560000

#### SD TO 0,6x3,0

Angled slotted screwdriver with round handle, SoftFinish®@grip



SD TO 0,6X3,0	A		0.6	3	70	1323880000
---------------	---	--	-----	---	----	------------

**Weidmüller wrench set**

Socket wrench manufactured from through-hardened chromium-vanadium steel, manufactured according to DIN ISO 2936 L (DIN 911), high-quality finished surface.

**SK WSD S**

9-piece offset screwdriver set in the Prostar, with MagicRing: tightly holds standard screws in any position thanks to its spring steel ring (up to size 3), with ball head for screwing up to an angle of 25°.



Type	Size / AF	a	b	c	Order No.
	1.5				
	2				
	2.5				
	3				
	4				
	5				
	6				
	8				
	10				
SK WSD-S 1,5-10,0					9008850000

**SK S**

7-piece Allen key set



Type	Size / AF	a	b	c	Order No.
SKS 2,0-8,0					9008860000

**SK S MR**

7-piece Allen key set with ball head and MagicRing: holds standard screws (size 3 and larger) in any position thanks to its spring steel ring, with ball head for screwing up to an angle of 25°.



Type	Size / AF	a	b	c	Order No.
SKS 2,0-8,0 MR					9008870000

**TH S**

8-piece Torx®-TH Allen key set with hole in the bit tip (tamper-resistant), for screwing Torx® and Torx®-TH security screws (pin in centre of Torx® recess)



Type	Size / AF	a	b	c	Order No.
TH-S 9-40					9008880000

**Weidmüller wrench set****Weidmüller wrench set**

Weidmüller SoftFinish®screwdriver for general applications.

Bit made from fully hardened, high-alloy chromium-vanadium-molybdenum steel, matt-chrome finish.

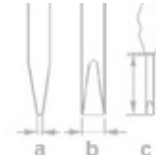
**System 11+1 S-PH-PZ-SK**

12-piece set with interchangeable bits for slotted, cross-head PH/PZ and hexagon head screws, SoftFinish®grip



Type	Size / AF	a	b	c	Order No.
SD					
SD					
SD					
SD					
PH 1					
PH 2					
PZ 1					
PZ 2					
SK					
SK					
SK					
SYSTEM 11+1				140	<b>9009750000</b>



**IS 4 / IS 6 / IS 8**

Wrench with pegged pilot tip



Hexagon screwdriver with cross-grip made from high-quality plastic

- Nickel-plated surface
- Made from hardened chromium-vanadium steel
- Manufactured according to DIN 6911
- Designed for screws acc. to DIN 6912

**IS 2 KG / IS 3 KG / IS 4 KG**

Socket wrench



Hexagon screwdriver with cross-grip made from high-quality plastic

- Nickel-plated surface
- Made from hardened chromium-vanadium steel
- Manufactured according to DIN 6911
- Designed for screws acc. to DIN 6912

**SDQ T15 / SDQ T20 / SDQ T40**

Socket wrench, Torx®



Torx® screwdriver with cross-grip made from high-quality plastic

- Matt-chrome surface finish
- Made from hardened chromium-vanadium steel

	IS4	IS6	IS8
c	60 mm	80 mm	90 mm
Weight	27 g	61 g	89 g

	IS 3 KG	IS 4 KG
c	100 mm	100 mm
Weight	32 g	32 g

	SDQ T15	SDQ T20	SDQ T40
c	100 mm	100 mm	100 mm
Weight	32 g	32 g	32 g

**Ordering data**

Type	Qty.	Order No.
IS 4 DIN 6911	1	0485100000
IS 6 DIN 6911	1	0407900000
IS 8 DIN 6911	1	0235000000

**Ordering data**

Type	Qty.	Order No.
IS 3 KG	1	1806650000
IS 4 KG	1	1806660000

**Ordering data**

Type	Qty.	Order No.
SDQ T15	1	1318390000
SDQ T20	1	1318400000
SDQ T40	1	1318410000

### Cross-Key Master

Universal key



- 1.0 x 7 mm    ● PH 2
- 5 mm □
- 7 mm □ 12 mm    9 mm ▲ 13.5 mm
- 8 mm □ 13.5 mm    4 mm ◀ 10 mm

- With bit holder and reversible bit (drives - refer to symbols)
- Material: diecast zinc
- Dimensions: 62 x 90 mm

#### Application:

For almost all technical locking systems in buildings including: doors, window handles, radiator bleed valves, sanitary installations, HVAC, gas and water supply.

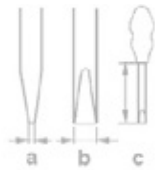

### Cross-Key Universal

Universal electrical cabinet key



- 1.0 x 7 mm    ● PH 2
- 5 mm □
- 6 mm □ 11.5 mm    9 mm ▲ 13.5 mm
- 7-8 mm □ 13.5 mm    3-5 mm ● 9 mm

- With bit holder and reversible bit (drives - refer to symbols)
- Material: diecast zinc
- Dimensions: 72 x 72 mm

#### Application:

For locking systems used in electrical engineering, fits all standard electrical cabinet locks.

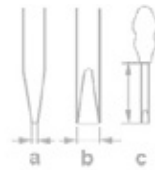

### Cross-Key Universal S

Universal mini electrical cabinet key



- 1.0 x 7 mm    ● PH 2
- 6 mm □ 11.5 mm    9 mm ▲ 13.5 mm
- 8 mm □ 13.5 mm    5 mm ● 9 mm

- With bit holder and reversible bit (drives - refer to symbols)
- Material: diecast zinc
- Dimensions: 42 x 42 mm

#### Application:

For locking systems used in electrical engineering, fits all standard electrical cabinet locks.



---

---

---

---

---

---

---

---

---

---

---

---

#### Ordering data

Type	Qty.	Order No.
CROSS-KEY MASTER	1	9918150000

---

---



---

---

---

---

---

---

---

---

---

---

---

---

#### Ordering data

Type	Qty.	Order No.
CROSS-KEY UNIVERSAL	1	9918130000

---

---



---

---

---

---

---

---

---

---

---

---

---

---

#### Ordering data

Type	Qty.	Order No.
CROSS-KEY UNIVERSAL S	1	9918140000

---

---





# Measuring / Testing

<b>Measuring / Testing</b>	Introduction	G.2
	Overview	G.4
	Digital voltage testers	G.6
	2-pole voltage tester	G.8
	Overview of digital multimeters	G.12
	Digital multimeters	G.13
	Digital multimeters and current-measuring clamp-on attachment	G.14
	Digital multimeter / Digital clamp-on measuring device	G.15
	Accessories	G.16
	Cable tester	G.17
	Non-contact magnetic field and voltage tester	G.18

# Measuring / Testing

















Testing plays a crucial role in setting up, maintaining and repairing electrical installations and devices. You should apply and adhere to the accident prevention and safety regulations relevant to your installation, which call for repeat tests after modifications and maintenance work, in addition to the tests required before using the installation for the first time.

The person responsible for setting up the installation is required to check that the installation or individual components function perfectly. They must also ensure their compliance with the technological regulations, in particular the VDE regulations and technical connection requirements (TAB) issued by the power supply companies. It is also important to check that all precautionary measures are taken to prevent extremely excessive contact voltage work and in order to guarantee and comply with the necessary safety standards. Using voltage and continuity testers from Weidmüller ensures that all tests are performed according to the relevant regulations.



Testing is very important during the setup, maintenance and repair of electrical facilities and equipment. You can conduct your tests properly with Weidmüller's voltage and continuity testers. All of our devices comply with all of the relevant standards.

## Overview of applications and testing functions

	6 V voltage test - e.g. models		400 V voltage test - 3-phase voltage systems		Semiconductor check
	12 V voltage test - e.g. car batteries		3-48 V measuring range		Load connection
	24 V voltage test - e.g. HGV batteries		Plug-in test probe		Phase sequence check
	50 V - limit of the dangerous voltage range for the human body		Car Check		Continuity check
	120 V voltage test - customary voltage in some countries, e.g. USA		Test probe illumination		
	230 V/240 V voltage test - customary voltage in the majority of European countries		Polarity check		



### 2-pole voltage testers

The main purpose of the voltage tester is to check the presence or absence of a voltage. The 2-pole voltage tester is an approved testing instrument that satisfies the requirements of the Industrial Safety Act.



### Digital multimeters

Multimeters are able to measure a number of different parameters. The measuring options for voltage and resistance, plus continuity testing and the diode test are available on every instrument as standard.



### Digital clamp-on meters

Digital clamp-on meters and clamp-on meter attachments and adapters are used for measuring AC and DC currents. The important advantage of these devices is that the measurements can be undertaken without interrupting the flow of current.



### Network tester

Network testers enable you to make quick cabling tests and quick diagnoses of cabling errors.

# Overview

## Technical specification

Type designation	Digi Check Pro	Digi Check	Multi Check	Combi Check Pro	Combi Check	Master Check	LSP 4L	LSP 4B	Volt Check	Car Check
Page number	G.6	G.6	G.7	G.8	G.8	G.9	G.10	G.10	G.11	G.11
Order No.	9918870000	9918850000	9918920000	1279330000	9918860000	9918880000	9205050000	9205060000	9918950000	9918970000
Rated voltage range	0,3 - 690 V AC/DC	0,3 - 690 V AC/DC	5 - 500 V AC/DC	6 - 690 V AC/DC	6 - 690 V AC/DC	6 - 400 V AC/DC	12 - 690 V AC/DC	12 - 690 V AC/DC	6 - 400 V AC/DC	3 - 48 V DC
Display	digital LCD	digital LCD	digital LCD	LED	LED	LED	LED	LED	LED + reflector	LED
< 6 V	x	x	x							x
6 V	x	x	x	x	x	x			x	3-48 V
12 V	x	x	x	x	x	x	x			
24 V	x	x	x	x	x	x	x	x		
50 V	x	x	x	x	x	x	x	x	x	
120 V	x	x	x	x	x	x	x	x	x	
230 V	x	x	x	x	x	x	x	x	x	
400 V	x	x	x	x	x	x	x	x	x	
690 V	x	x		x	x			x		
Polarity (+/-)	x	x	x	x	x	x	x	x	x	x
Continuity test	x	x	x	x	x	x	x	x		
Single-pole phase test	x	x	x	x	x		x	x		
One-hand testing	x	x	x	x	x	x				
Illuminated measuring probes	x	x		x	x					
HOLD function	x	x	x							
Phase sequence indicator	x			x	x		x	x		
Switchable load	x			x						
30 mA RCD triggering via a button	x			x						
Power supply	2 x 1,5 V AAA	2 x 1,5 V AAA	2 x 1,5 V AAA	2 x 1,5 V AAA	2 x 1,5 V AAA	2 x 1,5 V AAA	rechargeable battery	rechargeable battery		
Order no., battery	9201310000	9201310000	9201310000	9201310000	9201310000	9201310000				
Order no., case	9201520000	9201520000	9201520000	9201520000	9201520000	9201520000	9201520000	9201520000	9201520000	9201520000
Order no., spare battery cover		1332410000	1332410000	1332410000	1332410000	1332410000				
Order no., spare test probe protectors	1332420000	1332420000	1332420000	1332420000	1332420000	1332420000				

Safety features										
Category	CAT IV - 400 V CAT III - 690 V	CAT IV - 400 V CAT III - 690 V	CAT IV - 400 V CAT III - 690 V	CAT IV - 400 V CAT III - 690 V	CAT IV - 400 V CAT III - 690 V	CAT IV - 400 V CAT III - 690 V	CAT IV	CAT IV		
Peak resistance voltage	8 kV	8 kV	8 kV	8 kV	8 kV	8 kV	12 kV	12 kV	5 kV	
Standard	VDE0682 Part 401	VDE0682 Part 401	VDE0682 Part 401	VDE0682 Part 401	VDE0682 Part 401	VDE0682 Part 401	VDE0682 Part 401	VDE0682 Part 401	VDE 0411 Part 031	
EN/IEC standard	EN/ IEC 61243-3: 2010-10	EN/ IEC 61243-3: 2010-10	EN/ IEC 61243-3: 2010-10	EN/ IEC 61243-3: 2010-10	EN/ IEC 61243-3: 2010-10	EN/ IEC 61243-3: 2010-10	EN/ IEC 61243-3	EN/ IEC 61243-3	EN/IEC 61010 - 031	
Dimensions	287 x 68 x 23	287 x 68 x 23	287 x 68 x 23	287 x 68 x 23	287 x 68 x 23	287 x 68 x 23	231 x 48 x 37	231 x 48 x 37	190 x 25 x 19	137 x 21 x 18
Weight	290 g	290 g	290 g	290 g	290 g	290 g	170 g	170 g	70 g	57 g
Protection class	IP 65	IP 65	IP 65	IP 65	IP 65	IP 65	IP 65	IP 65	IP 40	
Operating temperature	-15 °C...+45 °C	-15 °C...+45 °C	-15 °C...+45 °C	-15 °C...+45 °C	-15 °C...+45 °C	-15 °C...+45 °C	-10 °C...+55 °C	-10 °C...+55 °C	-10 °C...+50 °C	-10 °C...+50 °C

Digi-Check Pro



Digi-Check



Multi-Check



Combi-Check Pro



Combi-Check



Master-Check



LSP 3 - 400 V



LSP 3 - 690 V



Car-Check



Volt-Check 3.1





## Digital voltage tester

### Digital voltage testers

- LCD display including bar chart
- One-hand testing is possible
- Test probe protection
- Continuity test
- Low-battery indicator
- HOLD function
- Backlit
- Polarity detection
- Single-pole phase test is possible
- Battery included
- Battery compartment opener included
- Large display
- Light sensor
- IP 65

### Digi-Check Pro

Digital voltage tester



- Test probe illumination
- Selectable load for residual current testing
- Phase sequence indicator
- Frequency measurement
- Buzzer included
- Case included

### Digi-Check

Digital voltage tester



- Test probe illumination
- Frequency measurement
- Buzzer included
- Battery compartment opener included
- Battery included



### Technical data

Nominal voltage
Input resistance, voltage
Peak voltage resistance
Frequency range, min.
Measuring range category
Display
Operating temperature, min.
Protection degree
Approvals
Weight
<b>Note</b>

<b>DIGI CHECK PRO</b>
0.30 V...690 V AC/DC
On operating the double switch $\geq 300 \text{ k}\Omega$
8 kV
0...100 Hz
CATIV - 400V/ CAT III - 690V
LCD
-15...45 °C
IP 65
EN/IEC 61243-3 :2010-10 (VDE 0682 Part 401)
290 g
Buzzer included

<b>DIGI CHECK</b>
0.30 V...690 V AC/DC
$\geq 300 \text{ k}\Omega$
8 kV
0...100 Hz
CATIV - 400V/ CAT III - 690V
LCD
-15...45 °C
IP 65
EN/IEC 61010-1
290 g
Buzzer included

### Ordering data

<b>Version</b>
<b>Note</b>

Type	Qty.	Order No.
DIGI CHECK PRO	1	9918870000
Digi Check Pro 2MM	1	9201580000
Protective case included		

Type	Qty.	Order No.
DIGI CHECK	1	9918850000
Digi Check 2MM	1	9201590000

### Accessories

<b>Note</b>
-------------

Type	Qty.	Order No.
SKAI TASCHKE	1	9201520000
BATTERIE 1,5V MICRO	2	9201310000
PRSPSU	1	1332420000

Type	Qty.	Order No.
SKAI TASCHKE	1	9201520000
BATTERIE 1,5V MICRO	2	9201310000
PRSPSU	1	1332420000

## Multi-Check

Digital voltage tester

**MULTI CHECK**

0.30 V...500 V AC/DC

≥ 300 kΩ

8 kV

0...100 Hz

CATIV - 400V/ CAT III - 500V

LCD

-15...45 °C

IP 65

EN/IEC 61243-3 :2010-10 (VDE 0682 Part 401)

290 g

Type	Qty.	Order No.
MULTI CHECK	1	9918920000
Multi Check 2MM	1	9201570000

Type	Qty.	Order No.
SKAI TASCHÉ	1	9201520000
BATTERIE 1,5V MICRO	2	9201310000
PRSPSU	1	1332420000

## 2-pole voltage tester

### 2-pole voltage tester

- Automatic testing, identification and display of voltage type (AC or DC) and polarity
- Concisely arranged LED display
- Phase testing relative to earth
- Polarity testing
- Continuity and semiconductor testing
- Touch protection because of high input resistance
- Large voltage range
- IP65

### Combi-Check Pro

#### 2-pole voltage tester



- Phase sequence indicator
- Single-pole phase testing
- Selectable load for residual current testing
- Buzzer included
- Battery compartment opener included
- Batteries included

### Combi-Check

#### 2-pole voltage tester



- Phase sequence indicator
- Single-pole phase testing
- Buzzer included
- Battery compartment opener included
- Batteries included



### Technical data

Nominal voltage
Input resistance, voltage
Peak voltage resistance
Frequency range, min.
Measuring range category
Display
Operating temperature, min.
Protection degree
Approvals
Weight

#### Note

#### COMBI CHECK PRO

6 V...690 V AC/DC
On operating the double switch $\geq 300 \text{ k}\Omega$
8 kV
0...100 Hz
CATIV - 400V/ CAT III - 690V
LED
-15...45 °C
IP 65
EN/IEC 61243-3:2010-10 (VDE 0682 Part 401)
290 g
Buzzer included

#### COMBI CHECK

6 V...690 V AC/DC
8 kV
0...100 Hz
CATIV - 400V/ CAT III - 690V
LED
-15...45 °C
IP 65
290 g
Buzzer included

### Ordering data

#### Version

#### Note

Type	Qty.	Order No.
COMBI CHECK PRO	1	1279330000
COMBI CHECK PRO 2MM	1	1279550000

Type	Qty.	Order No.
COMBI CHECK	1	9918860000
Combi Check 2MM	1	9204230000

### Accessories

#### Note

Type	Qty.	Order No.
SKAI TASCHE	1	9201520000
BATTERIE 1,5V MICRO	2	9201310000
PRSPSU	1	1332420000

Type	Qty.	Order No.
SKAI TASCHE	1	9201520000
BATTERIE 1,5V MICRO	2	9201310000
PRSPSU	1	1332420000



**Master-Check**

2-pole voltage tester



- Battery compartment opener included
- Batteries included

**MASTER-CHECK**

6 V...400 V AC/DC

8 kV

0...100 Hz

CATIV - 400V/ CAT III - 400V

LED

-15...45 °C

IP 65

EN/IEC 61243-3 (VDE 0682 Part 401)

290 g

Type	Qty.	Order No.
MASTER CHECK	1	9918880000
Master Check 2MM	1	9201260000

Type	Qty.	Order No.
SKAI TASCHÉ	1	9201520000
BATTERIE 1,5V MICRO	2	9201310000
PRSPSU	1	1332420000

## 2-pole voltage tester

### 2-pole voltage tester

- Automatic testing, identification and display of voltage type (AC or DC) and polarity
- Clear display
- Phase testing relative to earth
- Polarity testing
- Continuity testing and semiconductor testing
- Touch-safety due to high input resistance
- Large voltage range

### LSP 4L

#### 2-pole voltage tester



- Maintenance free - without battery
- Integrated Lithium battery
- Surge-proof up to 8 kV
- Phase sequence indicator

### LSP 4B

#### 2-pole voltage tester



- Maintenance free - without battery
- Integrated Lithium battery
- Surge-proof up to 8 kV
- Phase sequence indicator

### Technical data

Nominal voltage
Input resistance, voltage
Peak voltage resistance
Frequency range, min.
Measuring range category
Display
Operating temperature, min.
Protection degree
Approvals
Weight
Note

<b>LSP 4L</b>
12 V AC/DC...690 V AC/DC
8 kV
0...500 Hz
CAT IV - 600V/ CAT III - 690V
digital
-15...45 °C
IP 65
EN/IEC 61243-3 :2010-10 (VDE 0682 Part 401)
170 g
Note

<b>LSP 4B</b>
12 V AC/DC...690 V AC/DC
8 kV
0...500 Hz
CAT IV - 600V/ CAT III - 690V
digital
-15...45 °C
IP 65
EN/IEC 61243-3 (VDE 0682 Part 401)
170 g
Note

### Ordering data

Version
Note

Type	Qty.	Order No.
LSP 4L	1	9205050000
Note		

Type	Qty.	Order No.
LSP 4B	1	9205060000
Note		

2-pole voltage tester

Car-Check

2-pole voltage tester for cars



- Test probe
- Pin with sliding mechanism
- Cable length 130 cm
- Polarity detection

Volt-Check 3.1

2-pole voltage tester



- LED indicator for voltage and phase
- Polarity detection

Technical data

Nominal voltage
Input resistance, voltage
Peak voltage resistance
Frequency range, min.
Display
Operating temperature, min.
Protection degree
Approvals
Weight
<b>Note</b>

<b>CAR-CHECK</b>
3 V DC...48 V DC
LED
-10...50 °C
57 g

<b>Volt-Check 3.1</b>
6 V AC/DC...400 V AC/DC
5 kV
0...100 Hz
LED
-10...50 °C
IP 40
EN/ IEC 61010
70 g

Ordering data

<b>Version</b>
<b>Note</b>

Type	Qty.	Order No.
CAR-CHECK	1	9918970000

Type	Qty.	Order No.
Volt-Check 3.1	1	9918950000

Accessories

<b>Note</b>

Type	Qty.	Order No.
SKAI TASCHE	1	9201520000

Type	Qty.	Order No.
SKAI TASCHE	1	9201520000

# Overview of digital multimeters

## Technical data

	Temphaser	125S	1037	2606	MG Kit CA 600
Page number	Page G.13	Page G.13	Page G.15	Page G.15	Page G.14
Order No.	<b>9427300000</b>	<b>9425830000</b>	<b>9423580000</b>	<b>9427370000</b>	<b>9427460000</b>
Measurement range					
• DC voltage	0.2 - 600 V	0.32 - 600 V	0.2 - 1,000 V	0.4 - 1,000 V	0.2 - 600 V
• AC voltage	0.2 - 600 V	0.32 - 600 V	0.2 - 750 V	0.4 - 750 V	0.2 - 600 V
• DC current				up to 1,000 A	0 - 600 A
• AC current				up to 1,000 A	0 - 600 A
• Resistance	up to 2,000 MΩ	up to 30 MΩ	up to 200 kΩ	up to 40 MΩ	up to 2,000 MΩ
• Capacitance	20 μF - 20 mF		up to 200 μF	4 nF - 40 μF	20 μF - 20 mF
• Frequency	10 Hz - 40 kHz			0.1 - 400 kHz	10 Hz - 40 kHz
• Temperature	-20 °C to +750 °C				-20 °C to +750 °C
Continuity test	x		x	x	x
Diode test	x	x	x	x	x
Phase sequence test	x				x
Selection of measuring range	manual	automatic	manual	automatic/manual	manual
HOLD function			x	x	
MAX/MIN function			x	x	
PEAK measurement				x	
Opening width of pliers			23 mm	57 mm	30 mm
Standard	EN/IEC 61010-1	EN/IEC 61010-1	EN/IEC 61010-1	EN/IEC 61010-1	EN/IEC 61010-1
Measurement range category	CAT III 600 V	CAT III 600 V	CAT III 1,000 V	CAT III 1,000 V	CAT III 600 V
Dimensions in mm	147 x 70 x 39	147 x 70 x 39	214,5 x 66 x 44	277 x 102 x 49	178 x 70 x 33

## Accessories

	9 V battery	9 V battery	9 V battery	9 V battery	9 V battery
Power supply	9 V battery	9 V battery	9 V battery	9 V battery	9 V battery
Order no., battery	<b>9004810000</b>	<b>9004810000</b>	<b>9004810000</b>	<b>9004810000</b>	<b>9004810000</b>
Accessories (included)	2 x Test wires with test probe 1 x Test wire with alligator clip 2 x Alligator clip 1 x Temperature probe 1 x Belt clip 1 x Spare fuse	2 x Test wires with test probe 1 x Belt clip	2 x Test wires 2 x Short test probe 2 x Long test probe 2 x Test wire with alligator clip, thin 2 x Test wire with alligator clip, wide 1 x Pliers adapter 1 x Carry case	2 x Test wires with test probe 1 x Carry case	2 x Test wires with test probe 1 x Test wire with alligator clip 2 x Alligator clip 1 x Temperature probe 1 x Belt clip 1 x Spare fuse 1 x Portable case
Order No.	<b>9205260000</b>	<b>9205270000</b>	<b>9205460000</b>	<b>9205270000</b>	<b>9205260000</b>
Accessories test wires	(without temperature probe)	(without temperature probe)	(without pliers adapter)	(without temperature probe)	(without temperature probe)

\*\*when connected with pliers adapter\* acc. to EN 61243-3, in all low-voltage systems up to 1,000 V

**Digital multimeters**

- Measures voltages up to 600 V
- Resistance measurement and semiconductor test
- Battery status display

**Temphaser**

Temphaser



- Voltage and resistance measurements
- Capacitance and frequency measurements
- Temperature measurement (including temp. probe)
- Phase sequence measurement

**Multimeter 125S**

Digital multimeter



- Voltage and resistance measurements
- Automatic measuring range selection



**Technical data**

DC voltage measuring range
Resolution of DC voltage
AC voltage measuring range
Resolution of AC voltage
Resistance measuring range
Measured capacitance value, min.
Frequency range, min.
Temperature measuring range
Operating temperature, min.
Approvals
Weight
<b>Note</b>

<b>TEMPHASER</b>
0.2 - 600 V
0#2 - 600 V
0.2...2000 MΩ
20...20 mF
10...40 kHz
-20...750 °C
0...50 °C
EN/IEC 61010-1
340 g
<b>Note</b>

<b>MULTIMETER 125S</b>
0.32 - 600 V
0#32 - 600 V
0.32...30 MΩ
0...100 Hz
0...50 °C
EN/IEC 61010-1
323 g
<b>Note</b>

**Ordering data**

<b>Version</b>
<b>Note</b>

Type	Qty.	Order No.
TEMPHASER	1	9427300000
<b>Note</b>		

Type	Qty.	Order No.
MULTIMETER 125S	1	9425830000
<b>Note</b>		

**Accessories**

<b>Note</b>
-------------

Type	Qty.	Order No.
ZUB TEMPHASER	1	9205260000
BLOCKBATTERIE 9V	1	9004810000
Delivered without temperature probe		
<b>Note</b>		

Type	Qty.	Order No.
ZUB MULTIMETER	1	9205270000
BLOCKBATTERIE 9V	1	9004810000
Delivered without belt clip		
<b>Note</b>		

## Digital multimeters and current-measuring clamp-on attachment

### Digital multimeters and current-measuring clamp-on attachment

- Measures voltages up to 600 V
- Measures currents up to 600 A with clamp-on attachment
- Resistance measurement and semiconductor test
- Battery status display

### MG KIT CA 600

Digital multimeter + clamp-on attachment



- Capacitance measurement
- Frequency measurement
- Temperature measurement
- Phase sequence measurement is possible



### Technical data

DC voltage measuring range
Resolution of DC voltage
AC voltage measuring range
Resolution of AC voltage
Measured current value, max.
Opening width of current-measuring clamp-on attachment
Resistance measuring range
Measured capacitance value, min.
Frequency range, min.
Temperature measuring range
Operating temperature, min.
Approvals
Weight

#### Note

### Ordering data

Version

Note

### Accessories

Note

### MG KIT CA 600

0.2 - 600 V

0#2 - 600 V

600 A

30 mm

0.2...2000 MΩ

20

10...40 kHz

-20...750 °C

0...50 °C

910 g

Type	Qty.	Order No.
MG KIT CA 600	1	9427460000

Type	Qty.	Order No.
ZUB TEMPHASER	1	9205260000
BLOCKBATTERIE 9V	1	9004810000

Delivered without temperature probe and belt clip

**Digital multimeter**

- Measures voltages up to 1000 V
- Resistance measurement and semiconductor test
- Capacitance measurement
- MAX/MIN memory
- HOLD function
- Battery status display
- Carry case included

**Multimeter 1037**

Digital multimeter



- Voltage measurement
- Current measurement
- Resistance measurement
- Non-contact voltage measurement is possible
- Extensive accessories

**Multimeter 2606**

Digital clamp-on measuring device



- Currents up to 1000 A measurable with clamp-on attachment
- Frequency measurement
- Voltage measurement
- Current measurement
- PEAK function

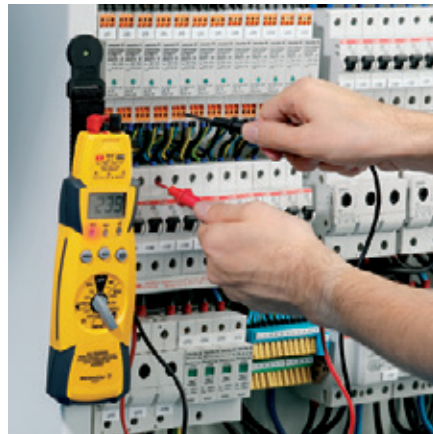

**Technical data**

DC voltage measuring range  
 Resolution of DC voltage  
 AC voltage measuring range  
 Resolution of AC voltage  
 Measured current value, max.  
 Opening width of current-measuring clamp-on attachment  
 Resistance measuring range  
 Measured capacitance value, min.  
 Frequency range, min.  
 Temperature measuring range  
 Operating temperature, min.  
 Approvals  
 Weight

**Note**

**MULTIMETER 1037**

0,2 - 1000 V

0#2 - 750 V

200 A

23 mm

0.2...200 kΩ

...200 µF

50...500 Hz

0...50 °C

EN/IEC 61010-1

258 g

**MULTIMETER C 2606**

0.4 - 1000 V

± 0.5%

0#4 - 1#000 V

± 0.5%

1000 A

57 mm

0.4...40 MΩ

40...4 µF

0.1...400 kHz

0...50 °C

VDE 0680, Part 5

540 g

**Ordering data**

Version

**Note**

**Accessories**

**Note**

Type	Qty.	Order No.
MULTIMETER 1037	1	9423580000

Type	Qty.	Order No.
ZUB MULTI 1037	1	9205460000
BLOCKBATTERIE 9V	1	9004810000

Pliers adapter or carry case are not included in the delivery of accessories

Type	Qty.	Order No.
MULTIMETER C 2606	1	9427370000

Type	Qty.	Order No.
ZUB MULTIMETER	1	9205270000
BLOCKBATTERIE 9V	1	9004810000

No carry case



**Accessories**

The accessories for our measuring instruments meet the same demanding standards for quality and safety as those used for our instruments.

**ZUB Temphaser**



Included in delivery	Qty.	Order No.
Test wire with test probe	2	
Test wire with alligator clip	1	
Alligator clip	2	
ZUB TEMPHASER		<b>9205260000</b>

**ZUB Multimeter 1037**



Test wire	2	
Short test probe	2	
Long test probe	2	
Test wire with alligator clip, thin	2	
Test wire with alligator clip, wide	2	
ZUB MULTI 1037		<b>9205460000</b>

**PS ZQV test adapter**



PS ZQV set: test wire with test probe	2	
PS ZQV: test probe	2	
PS_ZQV_SET		<b>1116710000</b>
PS_ZQV		<b>1121740000</b>

**ZUB Multimeter**



Test wire with test probe	2	
ZUB MULTIMETER		<b>9205270000</b>

**SKAI pouch**



Pouch for 2-pole voltage tester	1	
SKAI POUCH		<b>9201520000</b>

**Cable tester**

Test equipment to test Ethernet cables for:

- External voltage
- Cable breakage
- Wire breakage
- Short-circuit
- Crossed wires
- Checking for twisted wires
- Testable cable length: max. 1000 m
- Wire connection: RJ45
- External-voltage resistance: 80 V AC / DC

**LAN USB**

LAN continuity tester



- Network cable tester for LAN and USB connections
- Including remote tester
- Connection option for RJ45 plug
- Manual and automatic test
- Display of connection faults (cable breakage, wrong connection, incorrect wiring)

**IE-CT**



- External voltage
- External-voltage resistance: 80 V AC / DC



**Technical data**

Display	
Testable cable length, max.	
Supply	
Type of connection	
Remote box dimensions	
Remote box weight	
Length / Width / Height	mm
Weight	
<b>Note</b>	

LED	
1000	
9V battery	
RJ45, USB A, USB B	
65 x 28 x 27 mm	
30 g	
135 / 65 / 27	
174 g	

9V battery	
140 / 70 / 36	
185 g	

**Ordering data**

<b>Version</b>	
<b>Note</b>	

Type	Qty.	Order No.
LAN USB TESTER	1	9205400000
Battery, accessories and bag included in delivery		

Type	Qty.	Order No.
IE-CT	1	8808420000
Further test boxes on request Battery included		

## Non-contact magnetic field and voltage tester

### Non-contact magnetic field and voltage testers

- Reacts from a distance of 4 mm
- Batteries included
- In compliance with EN/IEC 61010-1

#### TB® 130

Non-contact magnetic field tester



- Flashlight function included
- Visual indication
- For operational testing of solenoid valves, relays, coils and contactors
- All magnetic fields can be tested

#### TB® 110

Non-contact voltage tester



- No current flow necessary thanks to capacitive method
- Detects voltage-conducting wires in sockets, cable reels, distributors, etc.
- Flashlight function included
- Visual indication
- Measuring range 12...1000 V AC

# G

### Technical data

Display
Protection degree
Weight
Battery type
<b>Note</b>

Visual
IP 44
45 g
1.5 V type AAA battery
<b>Note</b>

Visual
IP 44
45 g
1.5 V type AAA battery
<b>Note</b>

### Ordering data

<b>Version</b>
<b>Note</b>

Type	Qty.	Order No.
TB 130	1	9201390000
<b>Note</b>		

Type	Qty.	Order No.
TB 110	1	9201330000
<b>Note</b>		

### Accessories

<b>Note</b>
-------------

Type	Qty.	Order No.
BATTERIE 1,5V MICRO	2	9201310000
<b>Note</b>		

Type	Qty.	Order No.
BATTERIE 1,5V MICRO	2	9201310000
<b>Note</b>		

# Tool sets

<b>Tool sets</b>	Introduction	H.2
	Tool cases	H.4
	Crimp sets and accessories	H.6
	multi-stripax® PV and WM4 PV Set	H.11
	Inserts	H.12
	Assortment boxes and cases	H.14

# Weidmüller offers a comprehensive range of accessories

## Crimping sets

Workshops and companies prefer well-organised tool sets. This reduces searching and preparation times and thus saves hard cash. Weidmüller has recognised these important aspects and implements this in its product combinations. These product combinations stand out due to their high user benefit and functional features. Weidmüller crimping sets for cutting, stripping and crimping wire end ferrules provide you with practical works equipment for everyday use.







Tool case

Pro Case Premium



Assembly

Description of article	Type	Qty.
Sheathing stripper	AM 25	1
Cutting tool for up to 8-mm outer diameter	KT 8	1
Stripping tool for up to 10 mm <sup>2</sup>	STRIPAX	1
Crimping tool	PZ 6 ROTO L	1
Wire-end ferrule	H-BOX 0,5-2,5QMM DIN	1
Sheathing stripper for UTP and STP data cables	AM 12	1
Voltage tester up to 690 V/ 100 Hz LCD	DIGI CHECK	1
Voltage tester up to 690 V/ 100 Hz LED	COMBI CHECK	1
Toolbox, empty	Pro Case leer	1
Junct. box sheath. stripper w. indiv. core stripping unit/longitudinal cutter	STRIPPER ROUND TOP	1
VDE-insulated long-nose pliers with cutter, 160 mm long	FRZ S 160	1
VDE-insulated diagonal-cutting pliers, 180 mm long	SE HD 180	1
VDE-insulated combination pliers, 180 mm long	KBZ 180	1
VDE-insulated round-nose pliers with long jaws	RZ 160	1
VDE-insulated wire-stripping pliers for conductors up to 5mm diameter	AIZ 160	1
Universal electrical cabinet key	CROSS-KEY UNIVERSAL	1
Combined cutting/screwing tool	SWIFTY SET	1
Screwing tool	SK WSD-S 1,5-10,0	1
Slotted and crosshead PH screwdriver set	SD Set S2.5-5.5/PH1/2	1
VDE-insulated Slotted and crosshead PH-SD screwdriver set	SDI SL S3.5-6.5/PH1/2	1
Allen key with ball head	SKS 2,0-8,0 MR	1
Interchangeable bit for slotted screws, size 0.5 x 3	WK S 0,5x3,0	1
Torque screwdriver, from 0.5-1.7 Nm	DMS MANUELL 0,5-1,7	1

Technical data

Length / Width / Height	48 / 17 / 40 mm
Weight	8500 g

Ordering data

Type	Qty.	Order No.
Pro Case Premium	1	9202460000
Pro Case leer	1	9202470000

Pro Case Insta



Assembly

Description of article	Type	Qty.
Sheathing stripper	AM 25	1
Cutting tool for up to 8-mm outer diameter	KT 8	1
Stripping tool for up to 10 mm <sup>2</sup>	STRIPAX	1
Crimping tool	PZ 6 ROTO L	1
Wire-end ferrule	H-BOX 0,5-2,5QMM DIN	1
Sheathing stripper for UTP and STP data cables	AM 12	1
Voltage tester up to 690 V/ 100 Hz LED	COMBI CHECK	1
Tape measure	FLEXIMET 5 M	1
Toolbox, empty	Pro Case leer	1
Junct. box sheath. stripper w. indiv. core stripping unit/longitudinal cutter	STRIPPER ROUND TOP	1
VDE-insulated long-nose pliers with cutter, 160 mm long	FRZ S 160	1
VDE-insulated diagonal-cutting pliers, 180 mm long	SE HD 180	1
VDE-insulated combination pliers, 180 mm long	KBZ 180	1
Universal electrical cabinet key	CROSS-KEY UNIVERSAL	1
Screwing tool	SK WSD-S 1,5-10,0	1
VDE-insulated Slotted and crosshead PH-SD screwdriver set	SDI SL S3.5-6.5/PH1/2	1
Allen key with ball head	SKS 2,0-8,0 MR	1
Ring spanner set	PACK HEXA 8-13	1

Technical data

Length / Width / Height	48 / 17 / 40 mm
Weight	7680 g

Ordering data

Type	Qty.	Order No.
Pro Case Insta	1	9203160000
Pro Case leer	1	9202470000



## Top Case Premium



## Assembly

Description of article	Type	Qty.
Sheathing stripper	AM 25	1
Cutting tool for up to 8-mm outer diameter	KT 8	1
Stripping tool for up to 10 mm <sup>2</sup>	STRIPAX	1
Crimping tool	PZ 6 ROTO L	1
Wire-end ferrule	H-BOX 0,5-2,5QMM DIN	1
Sheathing stripper for UTP and STP data cables	AM 12	1
Voltage tester up to 690 V/ 100 Hz LCD	DIGI CHECK	1
Voltage tester up to 690 V/ 100 Hz LED	COMBI CHECK	1
Tool case	PLASTIC CASE	1
Junct. box sheath. stripper w. indv. core stripping unit/longitudinal cutter	STRIPPER ROUND TOP	1
VDE-insulated long-nose pliers with cutter, 160 mm long	FRZ S 160	1
VDE-insulated diagonal-cutting pliers, 180 mm long	SE HD 180	1
VDE-insulated combination pliers, 180 mm long	KBZ 180	1
VDE-insulated round-nose pliers with long jaws	RZ 160	1
Universal electrical cabinet key	CROSS-KEY UNIVERSAL	1
Combined cutting/screwing tool	SWIFTY SET	1
Screwing tool	SK WSD-S 1,5-10,0	1
Slotted and crosshead PH screwdriver set	SD Set S2.5-5.5/PH1/2	1
VDE-insulated Slotted and crosshead PH-SD screwdriver set	SDI SL S3.5-6.5/PH1/2	1
Allen key with ball head	SKS 2,0-8,0 MR	1
Interchangeable bit for slotted screws, size 0.5 x 3	WK S 0,5x3,0	1
Torque screwdriver, from 0.5-1.7 Nm	DMS MANUELL 0,5-1,7	1

## Technical data

Length / Width / Height	465 / 352 / 255 mm
Weight	11300 g

## Ordering data

Type	Qty.	Order No.
TOP CASE PREMIUM	1	1345320000
TOP CASE	1	1345330000

## Top Case Insta



## Assembly

Description of article	Type	Qty.
Sheathing stripper	AM 25	1
Cutting tool for up to 8-mm outer diameter	KT 8	1
Stripping tool for up to 10 mm <sup>2</sup>	STRIPAX	1
Crimping tool	PZ 6 ROTO L	1
Wire-end ferrule	H-BOX 0,5-2,5QMM DIN	1
Sheathing stripper for UTP and STP data cables	AM 12	1
Voltage tester up to 690 V/ 100 Hz LED	COMBI CHECK	1
Tool case	PLASTIC CASE	1
Junct. box sheath. stripper w. indv. core stripping unit/longitudinal cutter	STRIPPER ROUND TOP	1
VDE-insulated long-nose pliers with cutter, 160 mm long	FRZ S 160	1
VDE-insulated diagonal-cutting pliers, 180 mm long	SE HD 180	1
VDE-insulated combination pliers, 180 mm long	KBZ 180	1
Universal electrical cabinet key	CROSS-KEY UNIVERSAL	1
Screwing tool	SK WSD-S 1,5-10,0	1
VDE-insulated Slotted and crosshead PH-SD screwdriver set	SDI SL S3.5-6.5/PH1/2	1
Allen key with ball head	SKS 2,0-8,0 MR	1
Tape measure	FLEXIMET 5 M	1

## Technical data

Length / Width / Height	465 / 352 / 255 mm
Weight	10.8 kg

## Ordering data

Type	Qty.	Order No.
TOP CASE INSTA	1	1345310000
TOP CASE	1	1345330000

Crimp Set PZ 4



Crimp set for cutting, stripping and crimping of wire-end ferrules up to 4.0 mm<sup>2</sup>, consisting of:

- Assortment box PSC 01 blank
- A8 insert (4 pieces)
- A7 insert (2 pieces)
- Stripax® stripping tool for conductors with PVC insulation from 0.08...6.0 mm<sup>2</sup>
- PZ 4 crimping tool for wire-end ferrules from 0.5...4.0 mm<sup>2</sup>
- Wire-end ferrules with plastic collars H 0.5...H 4.0
- Weidmüller colour code

Crimp Set PZ 3



Crimp set for cutting, stripping and crimping of wire-end ferrules up to 6.0 mm<sup>2</sup>, consisting of:

- Assortment box PSC 01 blank
- A8 insert (6 pieces)
- A7 insert (1 piece)
- Stripax® stripping tool for conductors with PVC insulation from 0.08...6.0 mm<sup>2</sup>
- PZ 3 crimping tool for wire-end ferrules from 0.5...6.0 mm<sup>2</sup>
- Wire-end ferrules with plastic collars H 0.5...H 6.0
- Weidmüller colour code

Crimp Set PZ 6 roto



Crimp set for cutting, stripping and crimping of wire-end ferrules up to 6.0 mm<sup>2</sup>, consisting of:

- Assortment box PSC 01 blank
- A8 insert (6 pieces)
- A7 insert (1 piece)
- Stripax® stripping tool for conductors with PVC insulation from 0.08...6.0 mm<sup>2</sup>
- PZ 6 Roto crimping tool for wire-end ferrules from 0.14...6.0 mm<sup>2</sup>
- Wire-end ferrules with plastic collars H 0.5...H 6, Weidmüller colour code

H

Assembly

Type		Piece
STRIPAX	Stripping tool	1
PZ 4	Crimping tool	1
H0,5/14D W	Wire end ferrule	500
H0,75/14D GR	Wire end ferrule	500
H1,0/14D R	Wire end ferrule	500
H1,5/14D SW	Wire end ferrule	500
H2,5/15D BL	Wire end ferrule	500
H4,0/18D GR	Wire end ferrule	500

Technical data

Length / Width / Height	261 / 338 / 57 mm
Weight	1780 g

Ordering data

Colour code	Type	Order No.
Weidmüller	CRIMP-SET PZ 4	9025800000
DIN	CRIMP-SET PZ 4 D	9028630000
Misc.	CRIMP-SET PZ 4 T	9028640000

Assembly

Type		Piece
PZ 3	Crimping tool	1
STRIPAX	Stripping tool	1
H0,5/14D W	Wire end ferrule	500
H1,0/14D R	Wire end ferrule	500
H1,5/14D SW	Wire end ferrule	500
H0,75/14 HBL	Wire end ferrule	500
H2,5/15T GR	Wire end ferrule	500
H4,0/18T OR	Wire end ferrule	500
H6/26T GN	Wire end ferrule	100

Technical data

Length / Width / Height	261 / 338 / 57 mm
Weight	1743 g

Ordering data

Colour code	Type	Order No.
Weidmüller	CRIMP-SET PZ 3	9028650000
DIN	CRIMP-SET PZ 3 D	9028660000
Misc.	CRIMP-SET PZ 3 T	9028670000

Assembly

Type		Piece
STRIPAX	Stripping tool	1
PZ 6 ROTO L	Crimping tool	1
H0,5/14D W	Wire end ferrule	500
H1,0/14D R	Wire end ferrule	500
H1,5/14D SW	Wire end ferrule	500
H0,75/14 HBL	Wire end ferrule	500
H2,5/15T GR	Wire end ferrule	500
H4,0/18T OR	Wire end ferrule	500
H6,0/20T GN	Wire end ferrule	100

Technical data

Length / Width / Height	261 / 338 / 56 mm
Weight	1760 g

Ordering data

Colour code	Type	Order No.
Weidmüller	CRIMP-SET PZ 6 ROTO L	9028680000
DIN	CRIMP-SET PZ 6 ROTO L D	9028690000
Misc.	CRIMP-SET PZ 6 ROTO L T	9028700000

## Crimp Set PZ 6/5



Crimp set for cutting, stripping and crimping of wire-end ferrules up to 6.0 mm<sup>2</sup>, consisting of:

- Assortment box PSC 01 blank
- A8 insert (6 pieces)
- A7 insert (1 piece)
- Stripax stripping tool® for conductors with PVC insulation from 0.08...6.0 mm<sup>2</sup>
- PZ 6/5 crimping tool for wire-end ferrules from 0.25...10.0 mm<sup>2</sup>
- Wire-end ferrules with plastic collar H 0.5...H 6.0
- Weidmüller colour code

## Crimp Set stripax® plus



Crimp set for cutting, stripping and crimping of reel-packaged wire-end ferrules up to 2.5 mm<sup>2</sup>, consisting of:

- PSC 01 assortment box, clear with foam insert
- stripax® combination tool Plus for processing strips of linked wire-end ferrules of 0.5...2.5 mm<sup>2</sup> from Weidmüller
- Wire-end ferrules with plastic collars H 0.5...H 2.5
- Weidmüller colour code

## Crimp Set PZ 16



Crimp set for cutting, stripping and crimping of wire-end ferrules up to 16.0 mm<sup>2</sup>, consisting of:

- PSC 01 neutral assortment box
- A8 inserts (4 pieces)
- A7 inserts (2 pieces)
- stripax® 16 stripping tool® for conductors with PVC insulation from 6.0...16.0 mm<sup>2</sup>
- PZ 16 crimping tool for wire-end ferrules from 6.0...16.0 mm<sup>2</sup>
- Wire-end ferrules with plastic collar H 6.0...H 16.0
- DIN colour code

## Assembly

Type		Piece
STRIPAX	Stripping tool	1
PZ 6/5	Crimping tool	1
H0,5/14D W	Wire end ferrule	500
H1,0/14D R	Wire end ferrule	500
H1,5/14D SW	Wire end ferrule	500
H0,75/14 HBL	Wire end ferrule	500
H2,5/19T GR	Wire end ferrule	500
H4,0/18T OR	Wire end ferrule	500
H6,0,0/20T GN	Wire end ferrule	100

## Technical data

Length / Width / Height	261 / 338 / 57 mm
Weight	1761 g

## Ordering data

Colour code	Type	Order No.
Weidmüller	CRIMP-SET PZ 6/5	9028740000
DIN	CRIMP-SET PZ 6/5 D	9028750000
Misc.	CRIMP-SET PZ 6/5 T	9028760000

## Assembly

Type		Piece
STRIPAX PLUS 2.5	Crimping tool	1
H0,5/14D W BD	Wire end ferrule	500
H0,75/14T HBL BD	Wire end ferrule	500
H1,0/14D R BD	Wire end ferrule	500
H1,5/14D SW BD	Wire end ferrule	500
H2,5/14T GR BD	Wire end ferrule	500

## Technical data

Length / Width / Height	261 / 338 / 57 mm
Weight	1110 g

## Ordering data

Colour code	Type	Order No.
Weidmüller	CRIMP-SET STRIPAX PLUS	9028770000
DIN	CRIMP-SET STRIPAX PLUS D	9028780000
Misc.	CRIMP-SET STRIPAX PLUS T	9028790000

## Assembly

Type		Piece
STRIPAX	Stripping tool	1
PZ 16	Crimping tool	1
H6,0,0/20T GN	Wire end ferrule	100
H10,0/22T BR	Wire end ferrule	100
H16,0/22T W	Wire end ferrule	100
H16,0/28T W	Wire end ferrule	100

## Technical data

Length / Width / Height	261 / 338 / 57 mm
Weight	1725 g

## Ordering data

Colour code	Type	Order No.
Weidmüller	CRIMP-SET PZ 16	9025850000
DIN	CRIMP-SET PZ 16 D	9028800000
Misc.	CRIMP-SET PZ 16 T	9028810000

**Crimp Set PZ ZH 16**



Crimp set for cutting, stripping and crimping of twin wire-end ferrules up to 16.0 mm<sup>2</sup>, consisting of:

- Assortment box PSC 01 blank
- A7 insert (4 pieces)
- Stripax stripping tool® 16 for conductors with PVC insulation from 6.0...16.0 mm<sup>2</sup>
- Crimping tool PZ ZH 16 for twin wire-end ferrules from 6.0...16.0 mm<sup>2</sup>
- Wire-end ferrules with plastic collar H 6.0...H 16.0
- Weidmüller colour code

**Crimp Set PZ 50**



Crimp set for stripping and crimping of wire-end ferrules up to 50.0 mm<sup>2</sup>, consisting of:

- Assortment box PSC 01 blank
- A7 insert (4 pieces)
- Foam insert for tools
- Sheathing stripper AM 25 for round PVC cables of 6.0...25.0 mm<sup>2</sup>
- PZ 50 crimping tool for wire-end ferrules of 25, 35 and 50.0 mm<sup>2</sup>
- Wire-end ferrules with plastic collar H 25.0...H 50.0
- Weidmüller colour code

**H**

**Assembly**

Type		Piece
STRIPAX 16	Stripping tool	1
PZ ZH 16	Crimping tool	1
H6,0/23T ZH GN	Wire end ferrule	100
H6,0/29T ZH GN	Wire end ferrule	100
H10,0/24T ZH BR	Wire end ferrule	100
H16,0/29T ZH W	Wire end ferrule	50

**Assembly**

Type		Piece
AM 25	Sheathing strippers	1
PZ 50	Crimping tool	1
H35,0/30D 16 R	Wire end ferrule	50
H50/36D BL	Wire end ferrule	50
H25,0/30T SW	Wire end ferrule	50
H25,0/36T SW	Wire end ferrule	50

**Technical data**

Length / Width / Height	261 / 338 / 57 mm
Weight	1812 g

**Technical data**

Length / Width / Height	261 / 338 / 57 mm
Weight	1800 g

**Ordering data**

Colour code	Type	Order No.
Weidmüller	CRIMP-SET PZ ZH 16	9028820000
DIN	CRIMP-SET PZ ZH 16 D	9028830000
Misc.	CRIMP-SET PZ ZH 16 T	9028840000

**Ordering data**

Colour code	Type	Order No.
Weidmüller	CRIMP-SET PZ 50	9028850000
DIN	CRIMP-SET PZ 50 D	9028870000
Misc.	CRIMP-SET PZ 50 T	9028880000

## Crimp Set CTI 6



## Assembly

Description of article	Type	Qty.
Stripping tool for up to 10 mm <sup>2</sup>	STRIPAX	1
Crimping tool for insulated connectors, 0,5–6 mm <sup>2</sup>	CTI 6 S	1
Insulated ring-cable connector 6,0 mm <sup>2</sup> / M5	LIR 6M5 V	100
Insulated ring-cable connector 6,0 mm <sup>2</sup> / M6	LIR 6M6 V	100
Insulated pin-cable connector 6,0 mm <sup>2</sup> L=14 mm	LIP 6R14 V	100
Insulated ring-cable connector 2,5 mm <sup>2</sup> / M5	LIR 2,5M5 V	100
Insulated tab-connector sleeves 2,5 mm <sup>2</sup> / 6,3x0,8	LIF 2,5F638 R	100
Insulated pin-cable connector 1,5 mm <sup>2</sup> L=12 mm	LIP 1,5R12 V	100
Insulated pin-cable connector 2,5 mm <sup>2</sup> L=12 mm	LIP 2,5R12 V	100
Insulated joint connector 6,0 mm <sup>2</sup> L=26,0 mm	LIB 6B26 VF	100
Insulated ring-cable connector 1,5 mm <sup>2</sup> / M4	LIR 1,5M4 V	100
Insulated forked-cable connector 6,0 mm <sup>2</sup> / M6	LIS 6M6 V	100
Insulated tab-connector sleeves 1,5 mm <sup>2</sup> / 6,3x0,8	LIF 1,5F638 R	100
Insulated joint connector 2,5 mm <sup>2</sup> L=24,5 mm	LIB 2,5B25 VF	100
Insulated forked-cable connector 1,5 mm <sup>2</sup> / M4	LIS 1,5M4 V	100
Insulated forked-cable connector 2,0 mm <sup>2</sup> / M5	LIS 2,5M5 V	100
Insulated ring-cable connector 1,5 mm <sup>2</sup> / M5	LIR 1,5M5 V	100
Insulated ring-cable connector 2,5 mm <sup>2</sup> / M6	LIR 2,5M6 V	100
Insulated tab-connector sleeves 1,5 mm <sup>2</sup> / 2,8x0,8	LIF 1,5F288 R	100
Insulated tab-connector sleeves 6,0 mm <sup>2</sup> / 6,3x0,8	LIF 6F638 R	100
Insulated joint connector 1,5 mm <sup>2</sup> L=24,5 mm	LIB 1,5B25 VF	100
Assortment case, empty	KOF CARRYLITE 80	1

## Technical data

Length / Width / Height	413 / 330 / 79 mm
Weight	5 kg

## Ordering data

Type	Qty.	Order No.
Crimpsset CTI 6	1	9202600000



## Crimp Set PZ / CTI



## Assembly

Description of article	Type	Qty.
Stripping tool for up to 10 mm <sup>2</sup>	STRIPAX	1
Crimping tool for insulated connectors, 0.5-6 mm <sup>2</sup>	CTI 6 S	1
Crimping tool	PZ 6 Roto	1
Wire-end ferrule	H0,5/14D W	500
Wire end ferrule with plastic collar, yellow	H6,0/20D GE	100
Insulated ring-cable connector 6,0 mm <sup>2</sup> / M6	LIR 6M6 V	100
Insulated pin-cable connector 6,0 mm <sup>2</sup> L=14 mm	LIP 6R14 V	100
Insulated ring-cable connector 2,5 mm <sup>2</sup> / M5	LIR 2,5M5 V	100
Insulated tab-connector sleeves 2,5 mm <sup>2</sup> / 6,3x0,8	LIF 2,5F638 R	100
Insulated pin-cable connector 1,5 mm <sup>2</sup> L=12 mm	LIP 1,5R12 V	100
Insulated pin-cable connector 2,5 mm <sup>2</sup> L=12 mm	LIP 2,5R12 V	100
Insulated joint connector 6,0 mm <sup>2</sup> L=26,0 mm	LIB 6B26 VF	100
Insulated ring-cable connector 1,5 mm <sup>2</sup> / M4	LIR 1,5M4 V	100
Insulated tab-connector sleeves 1,5 mm <sup>2</sup> / 6,3x0,8	LIF 1,5F638 R	100
Insulated joint connector 2,5 mm <sup>2</sup> L=24,5 mm	LIB 2,5B25 VF	100
Insulated ring-cable connector 1,5 mm <sup>2</sup> / M5	LIR 1,5M5 V	100
Insulated tab-connector sleeves 1,5 mm <sup>2</sup> / 2,8x0,8	LIF 1,5F288 R	100
Insulated tab-connector sleeves 6,0 mm <sup>2</sup> / 6,3x0,8	LIF 6F638 R	100
Insulated joint connector 1,5 mm <sup>2</sup> L=24,5 mm	LIB 1,5B25 VF	100
Assortment case, empty	KOF CARRY LITE 80 PC RT	1

## Technical data

Length / Width / Height	413 / 330 / 79 mm
Weight	5 kg

## Ordering data

Type	Qty.	Order No.
Crimpset PZ / CTI	1	9202610000

## Crimp contact set



## Assembly

Description of article	Type	Qty.
Wire-end ferrule	H0,5/14D W	500
Wire end ferrule with plastic collar, yellow	H6,0/20D GE	100
Insulated ring-cable connector 6,0 mm <sup>2</sup> / M6	LIR 6M6 V	100
Insulated pin-cable connector 6,0 mm <sup>2</sup> L=14 mm	LIP 6R14 V	100
Insulated ring-cable connector 2,5 mm <sup>2</sup> / M5	LIR 2,5M5 V	100
Insulated tab-connector sleeves 2,5 mm <sup>2</sup> / 6,3x0,8	LIF 2,5F638 R	100
Insulated pin-cable connector 1,5 mm <sup>2</sup> L=12 mm	LIP 1,5R12 V	100
Insulated pin-cable connector 2,5 mm <sup>2</sup> L=12 mm	LIP 2,5R12 V	100
Insulated joint connector 6,0 mm <sup>2</sup> L=26,0 mm	LIB 6B26 VF	100
Insulated ring-cable connector 1,5 mm <sup>2</sup> / M4	LIR 1,5M4 V	100
Insulated tab-connector sleeves 1,5 mm <sup>2</sup> / 6,3x0,8	LIF 1,5F638 R	100
Insulated joint connector 2,5 mm <sup>2</sup> L=24,5 mm	LIB 2,5B25 VF	100
Insulated ring-cable connector 1,5 mm <sup>2</sup> / M5	LIR 1,5M5 V	100
Insulated tab-connector sleeves 1,5 mm <sup>2</sup> / 2,8x0,8	LIF 1,5F288 R	100
Insulated tab-connector sleeves 6,0 mm <sup>2</sup> / 6,3x0,8	LIF 6F638 R	100
Insulated joint connector 1,5 mm <sup>2</sup> L=24,5 mm	LIB 1,5B25 VF	100
Assortment case, empty	KOF.CARRY LITE 55 PC RT	1

## Technical data

Length / Width / Height	473 / 330 / 57 mm
Weight	3635 g

## Ordering data

Type	Qty.	Order No.
Crimp-Set Kontakte	1	9202640000

**Tool Set IE-POF**



**Contents:**

- Assortment case PSC 80
- Kevlar scissors for aramid fibres
- Multifunction tool HTX-IE-POF
- multi-stripax® stripping tool® IE-POF

**Assembly**

Type		Piece
HTX-IE-POF		1
multi-stripax IE-POF	Stripping tool	1
SCISSORS KEVLAR	Electrician's scissors	1

**Technical data**

Length / Width / Height	241 / 338 / 79 mm
Weight	1800 g

**Ordering data**

Colour code	Type	Order No.
	TOOL SET IE-POF	1208930000

**PV Set WM4**



**Contents:**

- CTF PV WM4 crimping tool
- Cutting and stripping tool multi-stripax® PV
- Multi-tool
- Photovoltaic contacts WM4
- Toolbag

**Assembly**

Type		Piece
CTF PV WM4	Crimping tool	1
multi-stripax PV	Stripping tool	1
SET MULTI-TOOL PV+	Accessories, Special tool	1
SFGH WM4 VPE100	Plug-in connector	100
SFKD WM4 VPE100		100
BUGH WM4 VPE100	Plug-in connector	100
BUKO WM4 VPE100		100
WZTE 20 LR		1
KDF CARRY LITE 80 PC RT	Empty box / Case	1

**Technical data**

Length / Width / Height	413 / 330 / 79 mm
Weight	2500 g

**Ordering data**

Colour code	Type	Order No.
	PV SET WM4	1257780000



Inserts

Inserts

Transparent, loose-packed compartment inserts for individual interior layouts.

- Resistant to oils, acids and alkalis
- Made from unbreakable polypropylene

A7-1 / A9-1 / A9-2

Inserts for PSC4-01, PSC5-01, CARRYLITE 55, CARRYLITE 80



- Inserts for PSC4-01, PSC5-01, CARRYLITE 55, CARRYLITE 80

A8-1 / A8-2

Inserts for PSC4-01, PSC5-01, CARRYLITE 55, CARRYLITE 80



- Inserts for horizontal installation

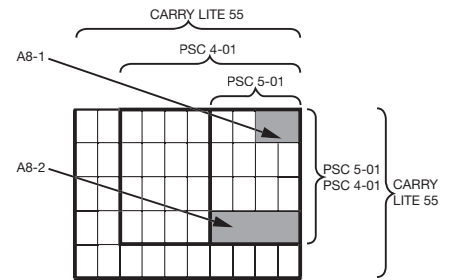
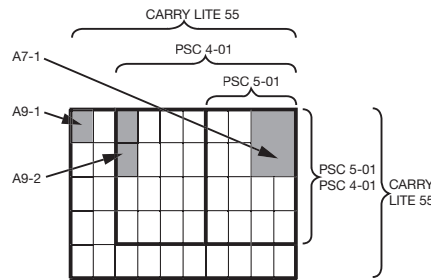

Technical data

Product data	
Colour of body	
Colour of fittings	
Cover material	
Weight	g
Dimensions	
Length	mm
Width	mm
Height	mm
Note	

EINSATZ A7-1 CL55	EINSATZ A9-1 CL55	EINSATZ A9-2 CL55
Natural	Natural	Natural
32	12	20
109	55	109
79	39	39
47	47	47

EINSATZ A8-1 CL55	EINSATZ A8-2 CL55
Natural	Natural
17	40
79	177
55	55
47	47

Ordering data

Version
Note

Type	Qty.	Order No.
EINSATZ A7-1 CL55	1	9028450000
EINSATZ A9-1 CL55	50	9202020000
EINSATZ A9-2 CL55	1	9203260000

Type	Qty.	Order No.
EINSATZ A8-1 CL55	100	9028460000
EINSATZ A8-2 CL55	1	9028420000

**Inserts**

Transparent, loose-packed compartment inserts for individual interior layouts.

- Resistant to oils, acids and alkalis
- Made from unbreakable polypropylene

**BA7-1 / BA8-1**

Inserts for PSC80



**BA8-1**

- Divider for horizontal installation

**BA7-1**

- Divider for vertical installation

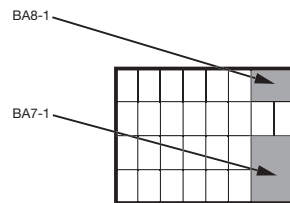

**Technical data**

Product data	
Colour of body	
Colour of fittings	
Cover material	
Weight	g
Dimensions	
Length	mm
Width	mm
Height	-
Note	

EINSATZ BA7-PSC 80	EINSATZ BA8-PSC 80
Natural	Natural
40	25
109	55
79	79
Note	

**Ordering data**

Version
Note

Type	Qty.	Order No.
EINSATZ BA7-PSC 80	1	9202320000
EINSATZ BA8-PSC 80	1	9202310000
Note		

Assortment boxes and cases

Assortment boxes and cases

- Body of case made from unbreakable polypropylene
- Portable and uncluttered storage in minimum space
- With 2 sturdy sliding catches
- Assortment cases and boxes can be placed upright and can be stacked safely without any sliding
- Can be subdivided with inserts
- U-section grid in cover and base holds the inserts in position and ensures sorted contents remain sorted
- Transparent polycarbonate cover
- Excellent shock resistance!
- With ergonomic carry handle

PSC4-01 / PSC 80

Assortment case, empty



CARRYLITE 55 / CARRYLITE 80

Assortment case, empty

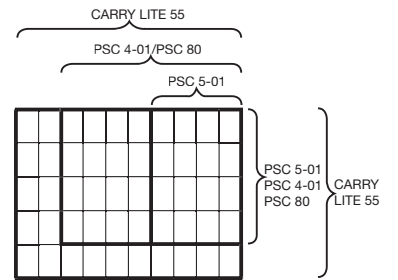
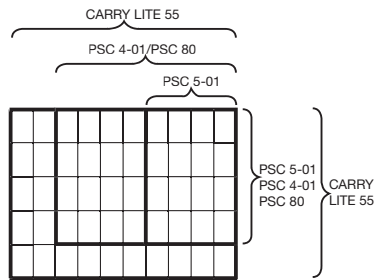

Technical data

Product data	
Colour of body	
Colour of fittings	
Cover material	
Weight	g
Dimensions	
Length	mm
Width	mm
Height	mm
Note	

KOFFER PSC4-01	KOFFER PSC80 PC
Anthracite	Anthracite
Orange	Orange
Polycarbonate	Polycarbonate
580	630
261	261
338	338
56	

KOFFER CARRY LITE 55	KOF CARRYLITE 80
Anthracite	Anthracite
Orange	Orange
Polycarbonate	Polycarbonate
1000	1250
330	330
413	413
57	79

Ordering data

Version
Note

Type	Qty.	Order No.
KOFFER PSC4-01	1	9028860000
KOFFER PSC80 PC	1	9202330000

Type	Qty.	Order No.
KOFFER CARRY LITE 55	1	9202000000
KOF CARRYLITE 80	1	1309580000

**PSC 5-01**

Assortment box, empty

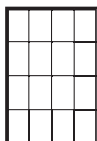

<b>KOFFER PSC5-01 PP</b>
Anthracite
Orange
Polypropylene
200
195
241

Type	Qty.	Order No.
KOFFER PSC5-01 PP	1	9202010000



# Automatic machines

<b>Automatic machines</b>	Introduction	1.2
	Cable cutting machines	1.4
	Automatic strippers	1.6
	Stripping and crimping machines	1.9

## Stripping and crimping machines

### Stripping and crimping machines: for linked or unconnected wire-end ferrules packaged in rolls

The crimping process can be made more efficient by automating the individual process steps. Markets will be placing increasing pressure on their strategic partners to optimise installation times. Machines that can efficiently process wiring materials are a state of the art solution for meeting this demand. Weidmüller's new generation of stripping and crimping machines are equipped with a universally adjustable stripping mechanism and a user-friendly touch screen. They also feature longer servicing intervals and machine lifespans.

And, there is no need to change tools

#### Touch screen

The new, large touch screen makes it easier to adjust and operate the machines.



#### Flexibility

A universally adjustable stripping mechanism comes with the machines' standard configuration. This stripping mechanism can be adjusted to fit various wire and insulation sizes.

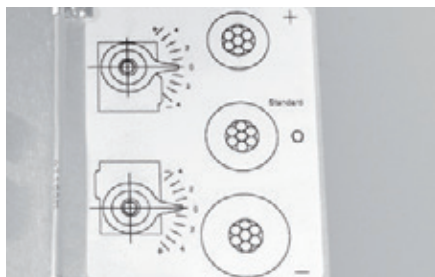



**Sturdy construction**

The new, sturdier construction results in more time between servicing and a longer lifespan for the machines.

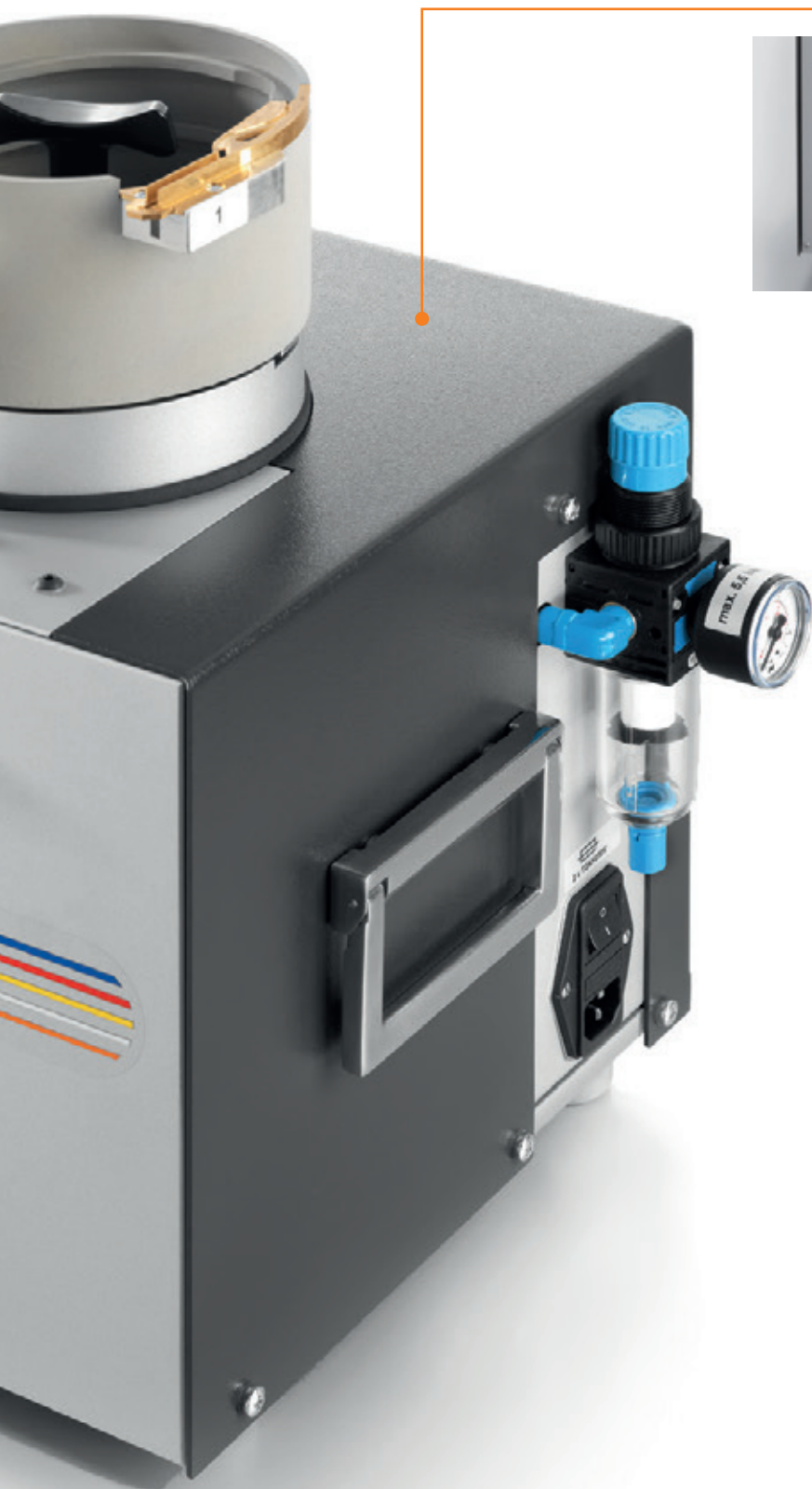

## Automatic machines



**CutFix 8****Cable cutting machines**

The CutFix 8 is a microprocessor-controlled tool for the automatic cutting to length of solid and flexible single conductors with a max. outer diameter of 8 mm.

Repetition accuracy is achieved by a precise servo DC drive.

- Optimised dimensional accuracy due to length correction (e.g. for special insulators)
- Adjustable cable clamping force
- RS232 interface for controlling the automatic sizer via an IBM-compatible PC
- Software (supplied) enables management, documentation and transfer of cutting jobs via a PC
- Removable hand-held terminal for entering individual cutting jobs

**Technical data****CutFix 8**

<b>Cutting capacity</b>	
Single conductor, flexible	0.14...10 mm <sup>2</sup>
Single conductor, solid	0.5...2.5 mm <sup>2</sup>
Aperture	Max. 8 mm outer Ø
<b>Feed rate</b>	
Feed rate	1.5 m/sec
<b>Length correction</b>	
Length correction	Slip correction in mm adjustable for specific articles
<b>Keypad</b>	
Keypad	4 x 4-buttons for data input
<b>Display</b>	
Display	4 lines/20 characters
<b>Length preselection</b>	
Length preselection	2 mm to 999999 mm
<b>Amount preselection</b>	
Amount preselection	Adjustable partial amount preselection
<b>Switch-off</b>	
Switch-off	When end of cable is reached
<b>Memory</b>	
Memory	For up to 256 cutting jobs
<b>Serial interface</b>	
Serial interface	1
<b>Software</b>	
Software	For data transfer to PC
<b>Electrical connection</b>	
Electrical connection	230 V/50 Hz
<b>Connected load</b>	
Connected load	Approx. 200 W
<b>Dimensions D x W x H (mm)</b>	
Dimensions D x W x H (mm)	330 x 380 x 498 with keypad 330 x 380 x 408 w/o keypad
<b>Weight</b>	
Weight	Approx. 24 kg

**Ordering data**

Type	Qty.	Order No.
CutFix 8	1	9023100000

**CCM****Cable cutting machines**

The CCM microprocessor-controlled automatic cutter cuts to length ribbon cables, round cables, insulating conduits and tubes. Its high repeat accuracy is achieved using a precision AC servodrive. The dimensional accuracy can, for particular requirements, be optimised by means of length correction.

Using a special subprogram, it is simplicity itself for customers to adapt the program interface to their own company-specific requirements. The pressure on the cable from the drive can be adjusted by the built-in pressure regulator that controls the pneumatic opening.

Software is available that allows cutting jobs to be managed, documented and transferred. The CCM can be used wherever stationary preparation of medium and large cable series is required. It comes with handles for easy relocation.

**Technical data****CCM**

Cutting force	Approx. 2900 N at 6 bar operating pressure
Aperture width	75 mm
Aperture height	40 mm
Ribbon cable	Max. cable width 75 mm
Solid and sheathed cables	up to Ø 25 mm
Single conductor, flexible	0.08...70 mm <sup>2</sup>
Single conductor, solid	0.08...16 mm <sup>2</sup>
Insulating tubes and hoses	Up to nominal width 29 mm
Feeding speed	0 - 3 m/sec, programmable
Length correction	Slip correction in mm programmable for specific articles
<b>Keypad</b>	
Keypad	4 x 4 buttons for data input, 4 direct function buttons
<b>Display</b>	
Display	4 lines/40 characters
<b>Languages</b>	
Languages	D, NL, F, UK, P, I, E, CZ
<b>Length preselection</b>	
Length preselection	1 mm to 999999 mm
<b>Amount preselection</b>	
Amount preselection	Adjustable partial amount preselection
<b>Switch-off</b>	
Switch-off	When cable end is reached
<b>Memory</b>	
Memory	For up to 20,000 cutting jobs
<b>Serial interface</b>	
Serial interface	1
<b>Software (optional)</b>	
Software (optional)	For data transfer to PC, additional programs for inkjet and embossing devices
<b>Electrical connection</b>	
Electrical connection	220 V/230 V AC
<b>Connected load</b>	
Connected load	Approx. 750 W
<b>Air connection</b>	
Air connection	6 - 10 bar
<b>Dimensions D x W x H (mm)</b>	
Dimensions D x W x H (mm)	470 x 360 x 370
<b>Exit tray</b>	
Exit tray	200 mm
<b>Weight</b>	
Weight	Approx. 35 kg

**Ordering data**

Type	Qty.	Order No.
CCM	1	9025440000

## Automatic strippers

### Automatic strippers

- Stripping of stranded wires according to DIN VDE 0295, Cl. 5
- Partial stripping; the insulation remains on the wire end
- No need to change tools
- Electric drive
- For small and medium-sized batches
- Precise adjustment possible through touch display
- Day and total unit counter ensures production monitoring

Automatic machines are designed to process wires acc. to DIN VDE 0295/5, DIN VDE 0281/102 and DIN VDE 0281/103.

Processing of other wire types on request.

### Powerstripper 6.0

0.05 ... 6.0 mm<sup>2</sup>



- Quick and easy adjustment to the respective cross-section
- Stripping length: 3...20 mm
- Min. conductor length: 22 mm + stripping length
- Max. outside diameter 5 mm

### Powerstripper 16.0

2.5...16.0 mm<sup>2</sup>



- Quick and easy adjustment to the respective cross-section
- Stripping length: 3...20 mm
- Min. conductor length: 22 mm + stripping length
- Max. outside diameter 8 mm

### Technical data

Specification	
Stripping range	
Conductor length, min.	
Pull-off length	
Pulse time	
Electrical connection	
Connection values	
Tool data	
Length / Width / Height	mm
Weight	kg
Note	

### Ordering data

Version
Note

POWERSTRIPPER 6,0		
Stripping range	0.05 - 6.0 mm <sup>2</sup> (~AWG 30-10)	
Conductor length, min.	22 mm + stripping length	
Pull-off length	3-20 mm	
Pulse time	approx. 0.5 s	
Electrical connection	100-240 V / 50/65 Hz	
Connection values	46 VA	
Tool data		
Length / Width / Height	295 / 190 / 190	
Weight	8.8	
Note		

Type	Qty.	Order No.
POWERSTRIPPER 6,0	1	9028510000
Note		

POWERSTRIPPER 16,0		
Stripping range	2.5 - 16 mm <sup>2</sup> (~AWG 14-6)	
Conductor length, min.	22 mm + stripping length	
Pull-off length	3-20 mm	
Pulse time	approx. 1.5 s	
Electrical connection	100-240 V / 50/65 Hz	
Connection values	46 VA	
Tool data		
Length / Width / Height	295 / 190 / 230	
Weight	11	
Note		

Type	Qty.	Order No.
POWERSTRIPPER 16,0	1	9028480000
Note		

## Automatic strippers

- Strips stranded wires according to DIN VDE 0295, Cl. 5
- Partial stripping of insulation; the insulation remains on the wire end
- Integrated sensing system for determining the wire cross-section and the resulting cutting depth
- Electric drive
- Change of tools not necessary
- For small and mid-sized batches
- Automatic adjustment to the appropriate wire cross-section

Automatic machines are designed to process wires according to DIN VDE 0295/5, DIN VDE 0281/102 and DIN VDE 0281/103.

Processing of other wire types on request.

### Powerstripper auto 2.5

0.5...2.5 mm<sup>2</sup>



#### Power stripper auto 2.5-20

- Stripping length from 3...20 mm
- Min. conductor length 22 mm plus stripping length

### Powerstripper auto 16.0

4.0 to 16 mm<sup>2</sup>



#### Power stripper auto 16-20

- Stripping length from 3...20 mm
- Min. conductor length 22 mm plus stripping length

## Technical data

Specification	
Stripping range	
Conductor length, min.	
Pull-off length	
Pulse time	
Electrical connection	
Connection values	
Tool data	
Length / Width / Height	mm
Weight	kg
Note	

## Ordering data

Version
Note

POWERSTRIPPER ao 2,5-20		
0.5 - 2.5 mm <sup>2</sup> (~AWG 20-14)		
22 mm + stripping length		
1-20 mm		
approx. 0.5 s		
100-240 V / 50/65 Hz		
46 VA		
295 / 190 / 205		
9		
Note		

Type	Qty.	Order No.
POWERSTRIPPER ao 2,5-20	1	9027270000
Note		

POWERSTRIPPER ao 16-20		
4 - 16 mm <sup>2</sup> (~AWG 12-6)		
22 mm + stripping length		
1-20 mm		
approx. 1.5 s		
100-240 V / 50/65 Hz		
46 VA		
295 / 190 / 230		
11		
Note		

Type	Qty.	Order No.
POWERSTRIPPER ao 16-20	1	9027290000
Note		

## Automatic strippers

### Automatic strippers

- Electro-pneumatic drive
- Precise sheath stripping on conductors with various insulation types
- Very easy to use

### Powerstripper AM 12

3.5...11.9 mm



- Stripping a cable with an outside diameter of 3.5 ... 11.9 mm
- Use of wire cross-sections with adapted V-radius blades
- Infinitely variable adjustment of sheath stripping and pull-off lengths between 25 and 120 mm
- Low weight and compact design
- Easy blade replacement

### Technical data

Specification	
Insertion length	
Min./max. stripping area	
Min./max. stripping length	
Pull-off length	
Electrical connection	
Compressed air connection	
Pulse time	
Tool data	
Length / Width / Height	mm
Weight	kg
Note	

Powerstripper AM 12	
Insertion length	80 mm
Min./max. stripping area	3.5 mm-11.90
Min./max. stripping length	25-120
Pull-off length	20 - 120 mm
Electrical connection	100-240 V / 50/65 Hz
Compressed air connection	5.5 bar
Pulse time	approx. 3 s
Tool data	
Length / Width / Height	230 / 254 / 520
Weight	17
Note	

### Ordering data

Version
Note

Type	Qty.	Order No.
Powerstripper AM 12	1	1534740000
Note		



**Stripping and crimping machines**

- For loose-packed wire-end ferrules with plastic collar
- Conductor stripping and crimping in one step
- Oscillating conveyor for grabbing free wire-end ferrules
- Quick adjustment to the required cross-section range
- Change of tools not necessary, therefore efficient and time-saving processing

Automatic machines are designed to process wires according to DIN VDE 0295/5, DIN VDE 0281/102 and DIN VDE 0281/103.  
Processing of other wire types on request.

**Crimpfix 2.5 M**

0.34/0.5...2.5 mm<sup>2</sup>



- Electric drive
- For smaller batches

**Crimpfix 2.5 M**

- 0.34 / 0.5...2.5 mm<sup>2</sup>
- Processing 0.34 mm<sup>2</sup> is possible with simple conversion tool

**Crimpfix R / Crimpfix RS**

0.5...2.5 mm<sup>2</sup>



**Crimpfix R**

- 0.5...2.5 mm<sup>2</sup>
- Crimping length: 8 mm

**Crimpfix RS**

- 0.5...2.5 mm<sup>2</sup>
- Crimping length: 8 mm & 10 mm

**Technical data**

Specification	
Stripping range	
Crimping length	
Length of wire-end ferrule	
Pulse time	
Cross-section range	
Electrical connection	
Compressed air connection	
Tool data	
Length / Width / Height	mm
Weight	kg
Note	

**Ordering data**

Version
Note

CRIMPFIX 2.5 M		
Stripping range	0.34/0.5 - 2.5 mm <sup>2</sup>	
Crimping length	8 mm	
Length of wire-end ferrule	14 mm	
Pulse time	approx. 1.5 s	
Cross-section range	0.5...2.5 mm <sup>2</sup>	
Electrical connection	220 V / 50 Hz	
Compressed air connection		
Length / Width / Height	292 / 310 / 260	
Weight	15	
Note		

Type	Qty.	Order No.
CRIMPFIX 2.5 M	1	9205410000
Note		

CRIMPFIX R	CRIMPFIX RS
Stripping range	0.5 - 2.5 mm <sup>2</sup>
Crimping length	8 mm
Length of wire-end ferrule	8/10 mm
Pulse time	14 mm
Cross-section range	approx. 1 s
Electrical connection	approx. 1 s
Compressed air connection	0.5...2.5 mm <sup>2</sup>
	100-240 V / 50/65 Hz
	100-240 V / 50/65 Hz
	5 bar
	5 bar
Length / Width / Height	330 / 390 / 430
Weight	330 / 390 / 430
	23
	23
Note	

Type	Qty.	Order No.
CRIMPFIX R	1	9028500000
CRIMPFIX RS	1	1477030000
Note		



## Stripping and crimping machines

### Stripping and crimping machines

- For loose-packed wire-end ferrules with plastic collar
- Conductor stripping and crimping in one step
- Oscillating conveyor for grabbing free wire-end ferrules
- Quick adjustment to the required cross-section range
- Change of tools not necessary, therefore efficient and time-saving processing

Automatic machines are designed to process wires according to DIN VDE 0295/5, DIN VDE 0281/102 and DIN VDE 0281/103.

Processing of other wire types on request.

### Crimpfix L / Crimpfix LS

0.5...2.5 mm<sup>2</sup>



- Electric/pneumatic drive
- Full electronic control
- For medium-sized batches

### Crimpfix LS

- Ferrules in custom sizes can also be processed

### Crimpfix LZ

2 x 0.5...2 x 1.5 mm<sup>2</sup>



### For twin wire-end ferrules

- Electro/pneumatic drive
- Complete electronic control
- For medium-sized batches

### Technical data

Specification	
Stripping range	
Crimping length	
Length of wire-end ferrule	
Pulse time	
Cross-section range	
Electrical connection	
Compressed air connection	
Tool data	
Length / Width / Height	mm
Weight	kg
Note	

### Ordering data

Version	
Note	

CRIMPFIX L	CRIMPFIX LS
0.5 - 2.5 mm <sup>2</sup>	0.5 - 2.5 mm <sup>2</sup>
8 mm	6/8/10 mm
14 mm	12/14/16 mm
approx. 1 s	approx. 1 s
0.5...2.5 mm <sup>2</sup>	0.5...2.5 mm <sup>2</sup>
100-240 V / 50/65 Hz	100-240 V / 50/65 Hz
5 bar	5 bar
330 / 390 / 460	330 / 390 / 460
31	31
Note	

Type	Qty.	Order No.
CRIMPFIX L	1	9028530000
CRIMPFIX LS	1	9028540000
Wire-end ferrules, see chapter J		

CRIMPFIX LZ	
2 x 0.5 - 2 x 1.5 mm <sup>2</sup>	
8 mm	
14 mm	
approx. 1 s	
0.5...1.5 mm <sup>2</sup>	
100-240 V / 50/65 Hz	
5 bar	
330 / 390 / 460	
31	
Note	

Type	Qty.	Order No.
CRIMPFIX LZ	1	9027310000
Wire-end ferrules, see chapter J		

**CA 100 C**0,14...0,34 mm<sup>2</sup>

The CA 100 C ("Compact") is an electro-pneumatic, modular crimping machine used to efficiently process unconnected (bulk-packed) ferrules with plastic collars. It is used for wires with small cross-sections of 0.14 to 0.34 mm<sup>2</sup> (AWG 26 to 22).

- For processing small cross-sections from 0.14 to 0.34 mm<sup>2</sup> (AWG 26 to 22), with 6/8 mm crimping lengths
- The removable control panel makes it convenient to operate and adjust.
- Simple, user-friendly menu navigation and touch-screen display
- Daily piece-part counter
- Short insertion length: 22 mm
- Tool is easy to change
- Quick setup and re-tooling
- Short cycle times: 1.5 s
- Crimping quality complies with DIN 46228
- Compact design
- Electro-pneumatic

**Technical data**

	CA 100 C
Crimping range	0.14 ... 0.34 mm <sup>2</sup>
Crimping lengths	6 ... 8 mm
Connection	220 V / 50 Hz
Drive	pneumatic
Compressed air connection	5 bar
Processing time	1.5 s
Size W x D x H	260 x 390 x 390
Weight	23 kg

The CA 100 C can be converted for conductor cross-sections in the ranges of 0.14 ... 0.34 mm<sup>2</sup>.

**Note on ordering**

In order to precisely determine the required conversion tool, you will need the exact specifications for both the wire-end ferrules being processed and the conductors being processed.

**Ferrules see chapter J**

Detailed quotation available on request. Additional accessories can be found in Chapter J.

**CA 100/2.5, CA 100/10**0,14...10 mm<sup>2</sup>

The CA 100 is an electro-pneumatic-driven automatic stripper and crimper for time-saving and efficient processing of loose-packed wire-end ferrules. It is designed for stationary preparation of medium-sized batches of conductors. The machine is characterised by rapid and simple operation.

- Stripping and crimping in one operation
- Electro-pneumatic drive
- Stripping and crimping range 0.14...10.0 mm<sup>2</sup>
- Processes ferrules of various lengths
- Rapid and easy conversion
- Vibration feeder takes loose ferrules

**Technical data**

	CA 100/2,5	CA 100/10
Crimping range	0.34 ... 4 mm <sup>2</sup> (using respective tool)	4 ... 10 mm <sup>2</sup>
Crimping lengths	6 ... 12 mm	6 ... 18 mm
Connection	220 V / 50 Hz	220 V / 50 Hz
Drive	pneumatic	pneumatic
Compressed air connection	5 bar	5 bar
Processing time	approx. 2.5 s	approx. 2.5 s
Crimping	Quadrocrimp	Trapezcrimp
Size W x D x H	530 x 400 x 460	530 x 400 x 460
Weight	40 kg	40 kg
Options	Quadrocrimp Tool: For a perfect 4 sided, crimped square	

The CA 100 can be converted for conductor cross-sections in the ranges of 0.14...2.5 or 4...10 mm<sup>2</sup>.

**Note on ordering**

In order to precisely determine the required conversion tool, you will need the exact specifications for both the wire-end ferrules being processed and the conductors being processed.

**Ferrules see chapter J**

Detailed quotation available on request. Additional accessories can be found in Chapter J.

## CA 4/8 Indent

0,14...4 mm<sup>2</sup>



The CA 4/8 Indent is an electro-pneumatic-driven automatic stripper and crimper for processing loose-packed, turned male and female contacts.

The contacts are fed automatically via an oscillating conveyor set-up.

Conductors and contacts in the 0.14 - 4.0 mm range (AWG 26-14) can be crimped normally with a 4/8 indent crimp shape, in compliance with MIL C-22520/1-01. The settings for stripping and crimp depth are motor-driven. The values can be saved in 50 different programs. The keyboard is used for configuration and programming.

Important data, functions and errors are shown on the LCD display.

With the help of the appropriate tools, the automatic crimper may be converted to various contacts and/or conductors.

It was developed for preparing conductors in medium-batch series for stationary use.

The automatic machine can be operated quickly and easily.

- Stripping and crimping in one operation
- Electro-pneumatic drive
- Strips and crimps 0.14...4.0 mm<sup>2</sup>
- Processes loose twisted pin and socket contacts
- Rapid and simple change-over
- Vibration-feeder takes 500 loose machined contacts
- 4/8-Indent crimp conforms with MIL C-22520/1-01
- Program memory for 50 contact variations
- Stripping and crimping dimensions adjusted by means of electric motor
- The CA 4/8 Indent S features an oscillating conveyor with selective feed. It uses sensors and actuators to ensure that the contacts are correctly positioned for processing.

### Technical data

	CA 4/8 Indent	CA 4/8 Indent S
Stripping range	0,14 ... 2,5 mm <sup>2</sup>	0,25 ... 4 mm <sup>2</sup>
Connection	220 V / 50 Hz / 115 VA	220 V / 50 Hz / 115 VA
Drive	pneumatic	pneumatic
Compressed air connection	5 bar	5 bar
Processing time	approx. 2,5 s	approx. 2,5 s
Size W x D x H	450 x 490 x 420	530 x 500 x 600
Weight	40 kg	54 kg
Options	special blade fixture (profile blade, V-radius blade), special fixing device for stranded wires, shortened insertion length, monitoring of entry, feed equipped with selection unit, control of crimping force, interface	

### Note on ordering

The machine is set up using sample contacts to suit the user's requirements. For this we need the name of the manufacturer, the type designation and the cross-sections of the contacts.

Detailed quotation available on request. Additional accessories can be found in our Heavy-Duty Connectors Catalogue.

# Accessories

---

<b>Accessories</b>	Introduction	J.2
	Wire-end ferrules with plastic collar	J.4
	Twin wire-end ferrules with plastic collar	J.10
	Wire-end ferrules for short-circuit-proof and earth-fault-proof cables	J.13
	Wire-end ferrules with plastic collars, special sizes	J.14
	Wire-end ferrules without plastic collar	J.15
	Assortment of wire-end ferrules	J.16
	Insulated cable connectors, PVC, with conical cable entry	J.18

---

# Accessories

Weidmüller stocks a comprehensive range of wire end ferrules and insulated cable lugs for immediate supply.

## Wire end ferrules

Wire end ferrules ensure the long-term quality of electrical connections. Another advantage is their usefulness during installation. The wide range of products embraces wire end ferrules with or without plastic collars and twin wire end ferrules in all the colours normally required by users.



## Insulated cable lugs

Insulated cable lugs ensure the long-term quality of electrical connections. Most of the products in the range (apart from the butt connectors) have a conical inlet. This guarantees optimum entry of the conductor as the strands are automatically centred.



### CSA - US certification

The following wire-end ferrules are CSA-US certified:



- Unconnected wire-end ferrules (bulk-packaged) from 0.14 mm<sup>2</sup> to 50 mm<sup>2</sup> (~ AWG 26 - 1)
- Twin wire-end ferrules from 2 x 0.5 mm<sup>2</sup> to 2 x 16 mm<sup>2</sup> (~ AWG 20 - 6)
- Special wire-end ferrules for use in small wire chambers and with AWG wires
- Tape-packaged wire-end ferrules on reels, or on belt, from 0.5 mm<sup>2</sup> to 2.5 mm<sup>2</sup> (~ AWG 20 - 14)
- Un-insulated wire-end ferrules from 0.14 mm<sup>2</sup> to 50 mm<sup>2</sup>

### UL certification

The following wire-end ferrules are UL certified:



- Unconnected wire-end ferrules (bulk packaged) from 0.14 mm<sup>2</sup> to 50 mm<sup>2</sup> (~ AWG 26 - 1)

## Tools

## Tools for insulated cable lugs

Tool	Order No.	0.5 - 1.5	Type of contact 1.5 - 2.5	4.0 - 6.0
CTI 6	9006120000	●	●	●
CTI 6 G	9202850000	●	●	●
HTI 15	9014400000	●	●	
Station		red	blue	yellow

## Crimping tools for ferrules

	PZ 1.5	stripax® plus 2.5	PZ 3	PZ 4	PZ 6 roto	PZ 6/5	PZ 16	PZ 50
	Order No.							
	9005990000	9020000000	0567300000	9012500000	9014350000	9011460000	9012600000	9006450000
Ferrule mm <sup>2</sup>								
H 0.14	●				●			
H 0.25	●				●	●		
H 0.34	●				●	●		
H 0.5	●	● <sup>1</sup>	●	●	●	●		
H 0.75	●	● <sup>1</sup>	●	●	●	●		
H 1.0	●	● <sup>1</sup>	●	●	●	●		
H 1.5	●	● <sup>1</sup>	●	●	●	●		
H 2.5		● <sup>1</sup>	●	●	●	●		
H 4.0			●	●	●	●		
H 6.0			●		●	●	●	
H 10.0							●	
H 16.0							●	
H 25.0								●
H 35.0								●
H 50.0								●

●<sup>1</sup> = ferrules in strip form only

Twin wire end ferrules are to be crimped according to the following table:

Tool	Order No.	H 0.5	H 0.75	H 1.0	H 1.5	Ferrules H 2.5	H 4.0	H 6.0	H 10.0	H 16.0
PZ 1.5	9005990000	●	●							
PZ 3	0567300000	●	●	●	●	●				
PZ 4	9012500000	●	●	●	●	●				
PZ 6 roto	9014350000	●	●	●	●	●	●			
PZ 6/5	9011460000		●	●	●	●	●			
Station		1.5 mm <sup>2</sup>	1.5 mm <sup>2</sup>	2.5 mm <sup>2</sup>	2.5 mm <sup>2</sup>	4 mm <sup>2</sup>	6 mm <sup>2</sup>			
PZ ZH 16	9013600000							●	●	●

## Wire-end ferrules with plastic collars

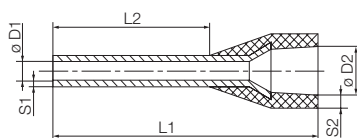

- Polypropylene conical entry funnel
- Heat-resistant up to 105°C
- The entry funnel can also be manufactured from a non-flammable material on request

For conductors from 0.14-150 mm<sup>2</sup> (AWG 26-300MCM)

Material E-Cu, electro-galvanised

Dimensional tolerance acc. to DIN 46228 Part 4

## Weidmüller colour code

### Packed loose



Type	Ø mm <sup>2</sup>	AWG	L1	L2	D1	D2	S1	S2	Stripping length	Colour	Qty.	Order No.
H0,25/10 HBL	0.25	AWG 24	10.00	6	0.8	1.8	0.15	0.25	8	Light Blue	500	9025740000
H0,25/12 HBL	0.25	AWG 24	12.00	8	0.8	1.8	0.15	0.25	10	Light Blue	500	9025760000
H0,34/10 TK	0.34	AWG 22	10.00	6	0.8	2	0.15	0.25	8	Turquoise	500	9025750000
H0,34/12 TK	0.34	AWG 22	12.00	8	0.8	2	0.15	0.25	10	Turquoise	500	9025770000
H0,5/12 OR	0.5	AWG 20	12.00	6	1	2.6	0.15	0.25	8	Orange	500	0409500000
H0,5/14 OR	0.5	AWG 20	14.00	8	1	2.6	0.15	0.25	10	Orange	500	0690700000
H0,5/16 OR	0.5	AWG 20	16.00	10	1	2.6	0.15	0.25	12	Orange	500	9025870000
H0,5/18 OR	0.5	AWG 20	18.00	12	1	2.6	0.15	0.25	14	Orange	500	1076980000
H0,75/12 W	0.75	AWG 18	12.00	6	1.2	2.8	0.15	0.25	8	White	500	0409600000
H0,75/14 W	0.75	AWG 18	14.00	8	1.2	2.8	0.15	0.25	10	White	500	0462900000
H0,75/16 W	0.75	AWG 18	16.00	10	1.2	2.8	0.15	0.25	12	White	500	9025860000
H0,75/18 W	0.75	AWG 18	18.00	12	1.2	2.8	0.15	0.25	14	White	500	9025910000
H1,0/12 GE	1	AWG 17	12.00	6	1.4	3	0.15	0.25	8	Yellow	500	0409700000
H1,0/14 GE	1	AWG 17	14.00	8	1.4	3	0.15	0.25	10	Yellow	500	0463000000
H1,0/16 GE	1	AWG 17	16.00	10	1.4	3	0.15	0.25	12	Yellow	500	9025950000
H1,0/18 GE	1	AWG 17	18.00	12	1.4	3	0.15	0.25	15	Yellow	500	9025930000
H1,5/14 R	1.5	AWG 16	14.00	8	1.7	3.5	0.15	0.25	10	Red	500	0463100000
H2,5/15D BL	2.5	AWG 14	15.00	8	2.2	4.2	0.15	0.25	10	Blue	500	9019160000
H1,5/16 R	1.5	AWG 16	16.00	10	1.7	3.5	0.15	0.25	12	Red	500	0635100000
H2,5/19D BL	2.5	AWG 14	19.00	12	2.2	4.2	0.15	0.25	14	Blue	500	9019170000
H1,5/24 R	1.5	AWG 16	24.00	18	1.7	3.5	0.15	0.25	20	Red	500	0565600000
H2,5/25D BL	2.5	AWG 14	25.00	18	2.2	4.2	0.15	0.25	20	Blue	500	9019180000
H4,0/18D GR	4	AWG 12	18.00	10	2.8	4.8	0.2	0.3	12	Grey	500	9019190000
H4,0/20D GR	4	AWG 12	20.00	12	2.8	4.8	0.2	0.3	14	Grey	500	9019200000
H4,0/26D GR	4	AWG 12	26.00	18	2.8	4.8	0.2	0.3	20	Grey	100	9019210000
H6,0/20 SW	6	AWG 10	20.00	12	3.5	6.3	0.2	0.3	14	Black	100	0533500000
H6,0/26 SW	6	AWG 10	26.00	18	3.5	6.3	0.2	0.3	20	Black	100	0565700000
H10,0/22 EB	10	AWG 7	22.00	12	4.5	7.6	0.2	0.4	15	Ivory	100	0534200000
H10,0/28 EB	10	AWG 7	28.00	18	4.5	7.6	0.2	0.4	21	Ivory	100	0565800000
H16,0/22 GN	16	AWG 6	22.00	12	5.8	8.8	0.2	0.4	15	Green	100	0565900000
H16,0/28 GN	16	AWG 6	28.00	18	5.8	8.8	0.2	0.4	21	Green	100	0566000000
H25,0/30 BR	25	AWG 3	30.00	16	7.3	11.2	0.2	0.4	18	Brown	50	0317000000
H25,0/36 BR	25	AWG 3	36.00	22	7.3	11.2	0.2	0.4	24	Brown	50	0317100000
H35,0/30 BE	35	AWG 2	30.00	16	8.3	12.7	0.2	0.4	19	Beige	50	0317200000
H35,0/39 BE	35	AWG 2	39.00	25	8.3	12.7	0.2	0.4	28	Beige	50	0317300000
H50/36 OLV	50	AWG 1	36.00	20	10.3	15	0.3	0.5	26	Olive	50	0444200000
H70,0/37 GE	70	AWG 2/0	37.00	21	12.7	16	0.35	0.6	26	Yellow	25	9028200000
H95,0/44 R	95	AWG 3/0	44.00	25	14.7	18	0.35	0.6	31	Red	25	9028210000
H120,0/50 BL	120	AWG 4/0	50.00	30	16.5	21	0.5	0.7	36	Blue	25	9028220000
H150,0/54 GE	150	AWG 300 MCM	54.00	32	18.5	23.5	0.5	0.75	38	Yellow	25	9028230000

## Weidmüller colour code

### In multi-pack bag



Type	Ø mm <sup>2</sup>	AWG	L1	L2	D1	D2	S1	S2	Stripping length	Colour	Qty.	Order No.
H0,14/10 GR	0.14	AWG 26	10.00	6	0.6	1.5	0.15	0.25	8	Grey	500	9005180000
H0,14/12 GR	0.14	AWG 26	12.00	8	0.6	1.5	0.15	0.25	10	Grey	500	9028240000
H0,25/10 HB	0.25	AWG 24	10.00	6	0.8	1.8	0.15	0.25	8	Light Blue	500	9026050000
H0,25/12 HB	0.25	AWG 24	12.00	8	0.8	1.8	0.15	0.25	10	Light Blue	500	9025780000
H0,34/10 TK	0.34	AWG 22	10.00	6	0.8	2	0.15	0.25	8	Turquoise	500	9026030000
H0,34/12 TK	0.34	AWG 22	12.00	8	0.8	2	0.15	0.25	10	Turquoise	500	9025790000
H0,5/12 OR	0.5	AWG 20	12.00	6	1	2.6	0.15	0.25	8	Orange	500	9028260000
H0,5/14 OR	0.5	AWG 20	14.00	8	1	2.6	0.15	0.25	10	Orange	500	9026060000
H0,5/16 OR	0.5	AWG 20	16.00	10	1	2.6	0.15	0.25	12	Orange	500	9028270000
H0,75/12 W	0.75	AWG 18	12.00	6	1.2	2.8	0.15	0.25	8	White	500	9028280000
H0,75/14 W	0.75	AWG 18	14.00	8	1.2	2.8	0.15	0.25	10	White	500	9026070000
H0,75/16 W	0.75	AWG 18	16.00	10	1.2	2.8	0.15	0.25	12	White	500	9028290000
H0,75/18 W	0.75	AWG 18	18.00	12	1.2	2.8	0.15	0.25	14	White	500	9028300000
H1,0/12 GE	1	AWG 17	12.00	6	1.4	3	0.15	0.25	8	Yellow	500	9028310000
H1,0/14 GE	1	AWG 17	14.00	8	1.4	3	0.15	0.25	10	Yellow	500	9026080000
H1,0/16 GE	1	AWG 17	16.00	10	1.4	3	0.15	0.25	12	Yellow	500	9028320000
H1,0/18 GE	1	AWG 17	18.00	12	1.4	3	0.15	0.25	15	Yellow	500	9028340000
H1,5/14 R S	1.5	AWG 16	14.00	8	1.7	3.5	0.15	0.25	10	Red	500	9026090000
H1,5/16 R S	1.5	AWG 16	16.00	10	1.7	3.5	0.15	0.25	12	Red	500	9028350000
H2,5/15 BL	2.5	AWG 14	15.00	8	2.2	4.2	0.15	0.25	10	Blue	500	9026100000
H4,0/18 GR	4	AWG 12	18.00	10	2.8	4.8	0.2	0.3	12	Grey	250	9026010000



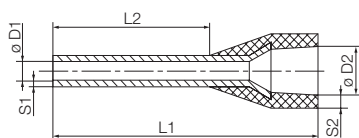

- Polypropylene conical entry funnel
- Heat-resistant up to 105°C
- The entry funnel can also be manufactured from a non-flammable material on request

For conductors from 0.14-150 mm<sup>2</sup> (AWG 26-300MCM)

Material E-Cu, electro-galvanised

Dimensional tolerance acc. to DIN 46228 Part 4

### Weidmüller colour code

#### Strips of linked wire-end ferrules



Type	Ø mm <sup>2</sup>	AWG	L1	L2	D1	D2	S1	S2	Stripping length	Colour	Qty.	Order No.
H0,5/14 OR BD	0.5	AWG 20	14.00	8	1	2.6	0.15	0.25	10	● Orange	500	9004270000
H0,75/14 W BD	0.75	AWG 18	14.00	8	1.2	2.8	0.15	0.25	10	○ White	500	9004290000
H1,0/14 GE BD	1	AWG 17	14.00	8	1.4	3	0.15	0.25	10	● Yellow	500	9004320000
H1,5/14 R BD	1.5	AWG 16	14.00	8	1.7	3.2	0.15	0.25	10	● Red	500	9004340000
H2,5/14D BL BD	2.5	AWG 14	14.00	8	2.5	4	0.15	0.25	11	● Blue	500	9004360000

### Weidmüller colour code

#### Reel of linked wire-end ferrules



Type	Ø mm <sup>2</sup>	AWG	L1	L2	D1	D2	S1	S2	Stripping length	Colour	Qty.	Order No.
H0,34/12 TK	0.34	AWG 22	12.00	8	0.8	2	0.15	0.25	10	● Turquoise	5000	9004390000
H0,5/14 OR	0.5	AWG 20	14.00	8	1	2.6	0.15	0.25	10	● Orange	5000	9005810000
H0,75/14 W	0.75	AWG 18	14.00	8	1.2	2.8	0.15	0.25	10	○ White	5000	9005820000
H1,0/14 GE	1	AWG 17	14.00	8	1.4	3	0.15	0.25	10	● Yellow	5000	9005830000
H1,5/14 R B	1.5	AWG 16	14.00	8	1.7	3.2	0.15	0.25	10	● Red	5000	9005840000
H2,5/14D BL	2.5	AWG 14	14.00	8	2.2	4	0.15	0.25	10	● Blue	3000	9005850000

## Wire-end ferrules with plastic collars

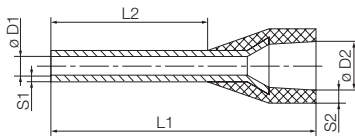

- Polypropylene conical entry funnel
- Heat-resistant up to 105 °C
- The entry funnel can also be manufactured from a non-flammable material on request

For conductors from 0.14-150 mm<sup>2</sup> (AWG 26-300MCM)

Material E-Cu, electro-galvanised

Dimensional tolerance acc. to DIN 46228 Part 4

### DIN colour code

#### Packed loose



Type	Ø mm <sup>2</sup>	AWG	L1	L2	D1	D2	S1	S2	Stripping length	Colour	VG*	Qty.	Order No.
H0.5/18D W	0.5	AWG 20	18.00	12	1	2.6	0.15	0.25	14	○ White	T 20A 003 A	500	1076990000
H0.5/12D W	0.5	AWG 20	12.00	6	1	2.6	0.15	0.25	8	○ White	T 20A 001 A	500	9019000000
H0.75/14D G	0.75	AWG 18	14.00	8	1.2	2.8	0.15	0.25	10	● Grey	T 20A 004 A	500	9019040000
H0.5/14D W	0.5	AWG 20	14.00	8	1	2.6	0.15	0.25	10	○ White	T 20A 002 A	500	9019010000
H0.5/16D W	0.5	AWG 20	16.00	10	1	2.6	0.15	0.25	12	○ White	T 20A 003 A	500	9019020000
H0.75/12D G	0.75	AWG 18	12.00	6	1.2	2.8	0.15	0.25	8	● Grey	T 20A 005 A	500	9019030000
H0.75/16D G	0.75	AWG 18	16.00	10	1.2	2.8	0.15	0.25	12	● Grey	T 20A 006 A	500	9019050000
H0.75/18D G	0.75	AWG 18	18.00	12	1.2	2.8	0.15	0.25	14	● Grey	T 20A 007 A	500	9019060000
H1.0/12D R	1	AWG 17	12.00	6	1.4	3	0.15	0.25	8	● Red	T 20A 008 A	500	9019070000
H1.0/14D R	1	AWG 17	14.00	8	1.4	3	0.15	0.25	10	● Red	T 20A 009 A	500	9019080000
H1.0/16D R	1	AWG 17	16.00	10	1.4	3	0.15	0.25	12	● Red	T 20A 010 A	500	9019100000
H1.0/18D R	1	AWG 17	18.00	12	1.4	3	0.15	0.25	15	● Red	T 20A 011 A	500	9019110000
H1.5/14D SW	1.5	AWG 16	14.00	8	1.7	3.5	0.15	0.25	10	● Black	T 20A 012 A	500	9019120000
H1.5/16D SW	1.5	AWG 16	16.00	10	1.7	3.5	0.15	0.25	12	● Black	T 20A 013 A	500	9019130000
H1.5/18D SW	1.5	AWG 16	18.00	12	1.7	3.5	0.15	0.25	15	● Black	T 20A 014 A	500	9019140000
H1.5/24D SW	1.5	AWG 16	24.00	18	1.7	3.5	0.15	0.25	20	● Black	T 20A 015 A	500	9019150000
H2.5/15D BL	2.5	AWG 14	15.00	8	2.2	4.2	0.15	0.25	10	● Blue	T 20A 017 A	500	9019160000
H2.5/19D BL	2.5	AWG 14	19.00	12	2.2	4.2	0.15	0.25	14	● Blue	T 20A 017 A	500	9019170000
H2.5/25D BL	2.5	AWG 14	25.00	18	2.2	4.2	0.15	0.25	20	● Blue	T 20A 018 A	500	9019180000
H4.0/18D GR	4	AWG 12	18.00	10	2.8	4.8	0.2	0.3	12	● Grey	T 20A 019 A	500	9019190000
H4.0/20D GR	4	AWG 12	20.00	12	2.8	4.8	0.2	0.3	14	● Grey	T 20A 020 A	500	9019200000
H4.0/26D GR	4	AWG 12	26.00	18	2.8	4.8	0.2	0.3	20	● Grey	T 20A 021 A	100	9019210000
H6.0/20D GE	6	AWG 10	20.00	12	3.5	6.3	0.2	0.3	14	● Yellow	T 20A 022 A	100	9019220000
H6.0/26D GE	6	AWG 10	26.00	18	3.5	6.3	0.2	0.3	20	● Yellow	T 20A 023 A	100	9019230000
H10.0/22D R	10	AWG 7	22.00	12	4.5	7.6	0.2	0.4	15	● Red	T 20A 024 A	100	9019240000
H10.0/28D R	10	AWG 7	28.00	18	4.5	7.6	0.2	0.4	21	● Red	T 20A 025 A	100	9019250000
H16.0/22D B	16	AWG 6	22.00	12	5.8	8.8	0.2	0.4	15	● Blue	T 20A 026 A	100	9019260000
H16.0/28D B	16	AWG 6	28.00	18	5.8	8.8	0.2	0.4	21	● Blue	T 20A 027 A	100	9019270000
H25.0/30D 1	25	AWG 3	30.00	16	7.3	11.2	0.2	0.4	18	● Yellow	T 20A 028 A	50	9019280000
H25.0/36D G	25	AWG 3	36.00	22	7.3	11.2	0.2	0.4	24	● Yellow	T 20A 030 A	50	9019300000
H35.0/30D 1	35	AWG 2	30.00	16	8.3	12.7	0.2	0.4	19	● Red	T 20A 031 A	50	9019310000
H35.0/32D R	35	AWG 2	32.00	18	8.3	12.7	0.2	0.4	19	● Red	T 20A 032 A	50	9019320000
H35.0/39D R	35	AWG 2	39.00	25	8.3	12.7	0.2	0.4	28	● Red	T 20A 033 A	50	9019330000
H50.0/41D B	50	AWG 1	41.00	25	10.3	15	0.3	0.5	31	● Blue	T 20A 035 A	50	9019350000
H50.0/36D BL	50	AWG 1	36.00	20	10.3	15	0.3	0.5	26	● Blue	T 20A 034 A	50	9019340000

### DIN colour code

#### In multi-pack bag



Type	Ø mm <sup>2</sup>	AWG	L1	L2	D1	D2	S1	S2	Stripping length	Colour	VG*	Qty.	Order No.
H0.75/14D G	0.75	AWG 18	14.00	8	1.2	2.8	0.15	0.25	10	● Grey	T 20A 005 A	500	9019410000
H0.5/14D W	0.5	AWG 20	14.00	8	1	2.6	0.15	0.25	10	○ White	T 20A 002 A	500	9019400000
H1.0/14D R	1	AWG 17	14.00	8	1.4	3	0.15	0.25	10	● Red	T 20A 009 A	500	9019420000
H1.5/14D SW	1.5	AWG 16	14.00	8	1.7	3.5	0.15	0.25	10	● Black	T 20A 012 A	500	9019430000
H2.5/15 BL	2.5	AWG 14	15.00	8	2.2	4.2	0.15	0.25	10	● Blue	T 20A 017 A	500	9026100000
H4.0/18 GR	4	AWG 12	18.00	10	2.8	4.8	0.2	0.3	12	● Grey	T 20A 019 A	250	9026010000

### DIN colour code

#### Strips of linked wire-end ferrules



Type	Ø mm <sup>2</sup>	AWG	L1	L2	D1	D2	S1	S2	Stripping length	Colour	VG*	Qty.	Order No.
H0.5/14D W	0.5	AWG 20	14.00	8	1	2.6	0.15	0.25	10	○ White	T 20A 002 A	500	9004280000
H0.75/14D G	0.75	AWG 18	14.00	8	1.2	2.8	0.15	0.25	10	● Grey	T 20A 005 A	500	9004300000
H1.0/14D R	1	AWG 17	14.00	8	1.4	3	0.15	0.25	10	● Red	T 20A 009 A	500	9004330000
H1.5/14D SW	1.5	AWG 16	14.00	8	1.7	3.2	0.15	0.25	10	● Black	T 20A 012 A	500	9004350000
H2.5/14D BL	2.5	AWG 14	14.00	8	2.5	4	0.15	0.25	11	● Blue	T 20A 017 A	500	9004360000

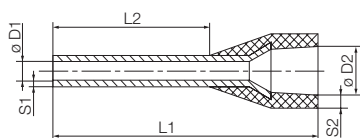

- Polypropylene conical entry funnel
- Heat-resistant up to 105 °C
- The entry funnel can also be manufactured from a non-flammable material on request

For conductors from 0.14-150 mm<sup>2</sup> (AWG 26-300MCM)  
 Material E-Cu, electro-galvanised  
 Dimensional tolerance acc. to DIN 46228 Part 4

**DIN colour code**

**Reel of linked wire-end ferrules**



Type	Ø mm <sup>2</sup>	AWG	L1	L2	D1	D2	S1	S2	Stripping length	Colour	Qty.	Order No.
H0,5/14D W BD GSP	0.5	AWG 20	14.00	8	1	2.6	0.15	0.25	10	○ White	5000	9005860000
H0,75/14D GR	0.75	AWG 18	14.00	8	1.2	2.8	0.15	0.25	10	● Grey	5000	9005870000
H1,0/14D R BD GSP	1	AWG 17	14.00	8	1.4	3	0.15	0.25	10	● Red	5000	9005880000
H1,5/14D SW BD GSP	1.5	AWG 16	14.00	8	1.7	3.2	0.15	0.25	10	● Black	5000	9005890000
H2,5/14D BL BD GSP	2.5	AWG 14	14.00	8	2.2	4	0.15	0.25	10	● Blue	3000	9005850000

## Wire-end ferrules with plastic collars

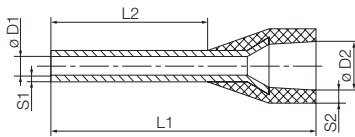

- Polypropylene conical entry funnel
- Heat-resistant up to 105 °C
- The entry funnel can also be manufactured from a non-flammable material on request

For conductors from 0.14-150 mm<sup>2</sup> (AWG 26-300MCM)

Material E-Cu, electro-galvanised

Dimensional tolerance acc. to DIN 46228 Part 4

### Other colour code

#### Packed loose



Type	Ø mm <sup>2</sup>	AWG	L1	L2	D1	D2	S1	S2	Stripping length	Colour	Qty.	Order No.
H0,25/10T GE	0.25	AWG 24	10.00	6	0.8	1.8	0.15	0.25	8	● Yellow	500	9021010000
H0,25/12T GE	0.25	AWG 24	12.00	8	0.8	1.8	0.15	0.25	10	● Yellow	500	9021020000
H0,5/12D W	0.5	AWG 20	12.00	6	1	2.6	0.15	0.25	8	○ White	500	9019000000
H0,5/14D W	0.5	AWG 20	14.00	8	1	2.6	0.15	0.25	10	○ White	500	9019010000
H0,5/16D W	0.5	AWG 20	16.00	10	1	2.6	0.15	0.25	12	○ White	500	9019020000
H0,75/12D GR	0.75	AWG 18	12.00	6	1.2	2.8	0.15	0.25	8	● Grey	500	9019030000
H0,75/14 HBL	0.75	AWG 18	14.00	8	1.2	2.8	0.15	0.25	10	● Light Blue	500	9021040000
H0,75/16T HBL	0.75	AWG 18	16.00	10	1.2	2.8	0.15	0.25	12	● Light Blue	500	9021050000
H0,75/18T HBL	0.75	AWG 18	18.00	12	1.2	2.8	0.15	0.25	14	● Light Blue	500	9021060000
H1,0/16D R	1	AWG 17	16.00	10	1.4	3	0.15	0.25	12	● Red	500	9019100000
H1,0/18D R	1	AWG 17	18.00	12	1.4	3	0.15	0.25	15	● Red	500	9019110000
H1,5/14D SW	1.5	AWG 16	14.00	8	1.7	3.5	0.15	0.25	10	● Black	500	9019120000
H1,5/16D SW	1.5	AWG 16	16.00	10	1.7	3.5	0.15	0.25	12	● Black	500	9019130000
H1,5/18D SW	1.5	AWG 16	18.00	12	1.7	3.5	0.15	0.25	15	● Black	500	9019140000
H1,5/24D SW	1.5	AWG 16	24.00	18	1.7	3.5	0.15	0.25	20	● Black	500	9019150000
H2,5/15T GR	2.5	AWG 14	15.00	8	2.2	4.2	0.15	0.25	10	● Grey	500	9021070000
H2,5/19T GR	2.5	AWG 14	19.00	12	2.2	4.2	0.15	0.25	14	● Grey	500	9021080000
H2,5/25T GR	2.5	AWG 14	25.00	18	2.2	4.2	0.15	0.25	20	● Grey	500	9021090000
H4,0/18T OR	4	AWG 12	18.00	10	2.8	4.8	0.2	0.3	12	● Orange	500	9021100000
H4,0/20T OR	4	AWG 12	20.00	12	2.8	4.8	0.2	0.3	14	● Orange	500	9021110000
H4,0/26T OR	4	AWG 12	26.00	18	2.8	4.8	0.2	0.3	20	● Orange	100	9021120000
H6,0/20T GN	6	AWG 10	20.00	12	3.5	6.3	0.2	0.3	14	● Green	100	9021130000
H6/26T GN	6	AWG 10	26.00	18	3.5	6.3	0.2	0.3	20	● Green	100	9021140000
H10,0/22T BR	10	AWG 7	22.00	12	4.5	7.6	0.2	0.4	15	● Brown	100	9021150000
H10,0/28T BR	10	AWG 7	28.00	18	4.5	7.6	0.2	0.4	21	● Brown	100	9021160000
H16,0/22T W	16	AWG 6	22.00	12	5.8	8.8	0.2	0.4	15	○ White	100	9021170000
H16,0/28T W	16	AWG 6	28.00	18	5.8	8.8	0.2	0.4	21	○ White	100	9021180000
H25,0/30T SW	25	AWG 3	30.00	16	7.3	11.2	0.2	0.4	18	● Black	50	9021190000
H25,0/36T SW	25	AWG 3	36.00	22	7.3	11.2	0.2	0.4	24	● Black	50	9021200000

### Other colour code

#### In multi-pack bag



Type	Ø mm <sup>2</sup>	AWG	L1	L2	D1	D2	S1	S2	Stripping length	Colour	Qty.	Order No.
H0,14/10T B	0.14	AWG 26	10.00	6	0.6	1.5	0.15	0.25	8	● Brown	500	9028250000
H0,25/10T G	0.25	AWG 24	10.00	6	0.8	1.8	0.15	0.25	8	● Yellow	500	9021210000
H0,25/12T G	0.25	AWG 24	12.00	8	0.8	1.8	0.15	0.25	10	● Yellow	500	9021220000
H0,5/14D W	0.5	AWG 20	14.00	8	1	2.6	0.15	0.25	10	○ White	500	9019400000
H0,75/14T H	0.75	AWG 18	14.00	8	1.2	2.8	0.15	0.25	10	● Light Blue	500	9021230000
H1,0/14D R	1	AWG 17	14.00	8	1.4	3	0.15	0.25	10	● Red	500	9019420000
H1,5/14D SW	1.5	AWG 16	14.00	8	1.7	3.5	0.15	0.25	10	● Black	500	9019430000
H2,5/15T GR	2.5	AWG 14	15.00	8	2.2	4.2	0.15	0.25	10	● Grey	500	9021240000
H4,0/18T OR	4	AWG 12	18.00	10	2.8	4.8	0.2	0.3	12	● Orange	250	9021250000

### Other colour code

#### Strips of linked wire-end ferrules



Type	Ø mm <sup>2</sup>	AWG	L1	L2	D1	D2	S1	S2	Stripping length	Colour	Qty.	Order No.
H0,5/14D W	0.5	AWG 20	14.00	8	1	2.6	0.15	0.25	10	○ White	500	9004280000
H0,75/14T H	0.75	AWG 18	14.00	8	1.2	2.8	0.15	0.25	10	● Light Blue	500	9004310000
H1,0/14D R	1	AWG 17	14.00	8	1.4	3	0.15	0.25	10	● Red	500	9004330000
H1,5/14D SW	1.5	AWG 16	14.00	8	1.7	3.2	0.15	0.25	10	● Black	500	9004350000
H2,5/14T GR	2.5	AWG 14	14.00	8	2.2	4	0.15	0.25	11	● Grey	500	9004370000

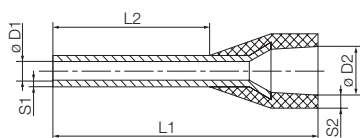

- Polypropylene conical entry funnel
- Heat-resistant up to 105 °C
- The entry funnel can also be manufactured from a non-flammable material on request

For conductors from 0.14-150 mm<sup>2</sup> (AWG 26-300MCM)

Material E-Cu, electro-galvanised

Dimensional tolerance acc. to DIN 46228 Part 4

### Other colour code

#### Reel of linked wire-end ferrules



Type	Ø mm <sup>2</sup>	AWG	L1	L2	D1	D2	S1	S2	Stripping length	Colour	Qty.	Order No.
H0,5/14D W BD GSP	0.5	AWG 20	14.00	8	1	2.6	0.15	0.25	10	○ White	5000	9005860000
H0,75/14T BL BD GSP	0.75	AWG 18	14.00	8	1.2	2.8	0.15	0.25	10	● Blue	5000	9005900000
H1,0/14D R BD GSP	1	AWG 17	14.00	8	1.4	3	0.15	0.25	10	● Red	5000	9005880000
H1,5/14D SW BD GSP	1.5	AWG 16	14.00	8	1.7	3.2	0.15	0.25	10	● Black	5000	9005890000
H2,5/14T GR BD GSP	2.5	AWG 14	14.00	8	2.2	4	0.15	0.25	10	● Grey	3000	9005910000

## Twin wire-end ferrules with plastic collars

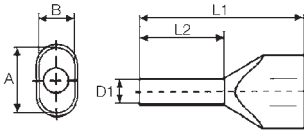

Polypropylene insertion funnel

Heat resistant up to 105 °C

If required, the insertion funnel can also be manufactured from a low-flammability material

For conductors of 2 x 0.5-2 x 16 mm<sup>2</sup> (2 x AWG 20-2 x AWG6)

Material E-Cu, tin-plated

Dimensional tolerance acc. to DIN 46228, part 4

## Weidmüller colour code

## Packed loose



Type	Ø mm <sup>2</sup>	AWG	L1	L2	D1	D2	S1	S2	Stripping length	Colour	Qty.	Order No.
H0,34/14 ZH TK	0.34	AWG 22	14.00				0.15			● Turquoise	500	1139070000
H0,5/14 ZH OR	0.5	AWG 20	14.00	8	1.4		0.15	0.3	11	● Orange	500	9037200000
H0,5/16 ZH OR	0.5	AWG 20	16.00	10	1.4		0.15	0.3	13	● Orange	500	9037210000
H0,5/18 ZH OR	0.5	AWG 20	18.00	12	1.4		0.15	0.3	15	● Orange	500	9037220000
H0,75/14 ZH W	0.75	AWG 18	14.00	8	1.7		0.15	0.3	11	○ White	500	9037230000
H0,75/16 ZH W	0.75	AWG 18	16.00	10	1.7		0.15	0.3	13	○ White	500	9037240000
H0,75/19S ZH W	0.75	AWG 18	19.00	12	1.7		0.15	0.3	21	○ White	500	9202820000
H0,75/24 ZH W	0.75	AWG 18	24.00	18	1.7		0.15	0.3	21	○ White	500	9037250000
H1,0/15 ZH GE	1	AWG 17	15.00	8	2		0.15	0.3	11	● Yellow	500	9037260000
H1,0/15S ZH GE	1	AWG 17	15.00	8	2.2		0.15	0.3	12	● Yellow	500	9018690000
H1,0/19 ZH GE	1	AWG 17	19.00	12	2		0.15	0.3	16	● Yellow	500	9037270000
H1,0/25 ZH GE	1	AWG 17	25.00	18	2		0.15	0.3	22	● Yellow	500	9037280000
H1,5/16 ZH R	1.5	AWG 16	16.00	8	2.2		0.15	0.3	11	● Red	500	9037290000
H1,5/20 ZH R	1.5	AWG 16	20.00	12	2.2		0.15	0.3	15	● Red	500	9037300000
H1,5/26 ZH R	1.5	AWG 16	26.00	18	2.2		0.15	0.3	21	● Red	100	9037310000
H2,5/19D ZH BL	2.5	AWG 14	19.00	10	2.8		0.15	0.4	13	● Blue	500	9037500000
H2,5/21D ZH BL	2.5	AWG 14	21.00	12	2.8		0.15	0.4	15	● Blue	100	9037510000
H2,5/27D ZH BL	2.5	AWG 14	27.00	18	2.8		0.15	0.4	21	● Blue	100	9037520000
H4,0/22D ZH GR	4	AWG 12	22.00	12	3.5		0.2	0.5	15	● Grey	100	9037530000
H4,0/28D ZH GR	4	AWG 12	28.00	18	3.5		0.2	0.5	21	● Grey	100	9037540000
H6,0/23 ZH SW	6	AWG 10	23.00	12	4.5		0.2	0.5	20	● Black	100	9037320000
H6,0/29 ZH SW	6	AWG 10	29.00	18	4.5		0.2	0.5	24	● Black	100	9037330000
H10,0/24 ZH EB	10	AWG 7	24.00	12	5.8		0.2	0.5	17	● Ivory	100	9037340000
H10,0/30 ZH EB	10	AWG 7	30.00	18	5.8		0.2	0.5	23	● Ivory	100	9037350000
H10,24S ZH EB	10	AWG 7	24.00	12	6.5		0.2	0.5	17	● Ivory	100	9018860000
H10,30S ZH EB	10	AWG 7	30.00	18	6.5		0.2	0.5	23	● Ivory	100	9018870000
H16,0/29 ZH GN	16	AWG 6	29.00	16	8.3		0.3	0.6	20	● Green	50	9037360000
H16,0/38 ZH GN	16	AWG 6	38.00	25	8.3		0.3	0.6	29	● Green	50	9037370000

## Weidmüller colour code

## In multi-pack bag



Type	Ø mm <sup>2</sup>	AWG	L1	L2	D1	D2	S1	S2	Stripping length	Colour	Qty.	Order No.
H0,5/14 ZH	0.5	AWG 20	14.00	8	1.4		0.15	0.3	11	● Orange	500	9004440000
H0,75/14 ZH	0.75	AWG 18	14.00	8	1.7		0.15	0.3	11	○ White	500	9018510000
H0,75/16 ZH	0.75	AWG 18	16.00	10	1.7		0.15	0.3	13	○ White	500	9004900000
H1,0/15 ZH	1	AWG 17	15.00	8	2		0.15	0.3	12	● Yellow	500	9018530000
H1,0/15S ZH	1	AWG 17	15.00	8	2.2		0.15	0.3	12	● Yellow	500	9018650000
H1,0/19 ZH	1	AWG 17	19.00	12	2		0.15	0.3	16	● Yellow	500	9004910000
H1,5/16 ZH	1.5	AWG 16	16.00	8	2.2		0.15	0.3	11	● Red	500	9004410000
H2,5/19D ZH	2.5	AWG 14	19.00	10	2.8		0.15	0.4	13	● Blue	250	9004430000
H1,5/20 ZH	1.5	AWG 16	20.00	12	2.2		0.15	0.3	15	● Red	500	9004920000
H2,5/21D ZH	2.5	AWG 14	21.00	12	2.8		0.15	0.4	15	● Blue	250	9004740000
H4,22D ZH G	4	AWG 12	22.00	12	3.5		0.2	0.5	15	● Grey	100	9004730000
H6,0/23 ZH	6	AWG 10	23.00	12	4.5		0.2	0.5	20	● Black	100	9004930000
H10,0/24 ZH	10	AWG 7	24.00	12	5.8		0.2	0.5	17	● Ivory	100	9004940000

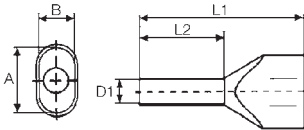

- Polypropylene conical entry funnel
- Heat-resistant up to 105°C
- The entry funnel can also be manufactured from a non-flammable material on request

For conductors of 2 x 0.5-2 x 16 mm<sup>2</sup> (2 x AWG 20-2 x AWG6)

Material E-Cu, electro-galvanised

Dimensional tolerance acc. to DIN 46228 Part 4

### DIN colour code

#### Packed loose



Type	Ø mm <sup>2</sup>	AWG	L1	L2	D1	D2	S1	S2	Stripping length	Colour	Qty.	Order No.
H0,5/14D ZH W	0.5	AWG 20	14.00	8	1.4		0.15	0.3	11	○ White	500	9037380000
H0,5/16D ZH W	0.5	AWG 20	16.00	10	1.4		0.15	0.3	13	○ White	500	9037390000
H0,5/18D ZH W	0.5	AWG 20	18.00	12	1.4		0.15	0.3	15	○ White	500	9037400000
H0,75/14D ZH GR	0.75	AWG 18	14.00	8	1.7		0.15	0.3	11	● Grey	500	9037410000
H0,75/16D ZH GR	0.75	AWG 18	16.00	10	1.7		0.15	0.3	13	● Grey	500	9037420000
H0,75/19DS ZH GR	0.75	AWG 18	19.00	12	1.7		0.15	0.3	21	● Grey	500	9202830000
H0,75/24D ZH GR	0.75	AWG 18	24.00	18	1.7		0.15	0.3	21	● Grey	500	9037430000
H1,0/15D ZH R	1	AWG 17	15.00	8	2		0.15	0.3	11	● Red	500	9037440000
H1,0/19D ZH R	1	AWG 17	19.00	12	2		0.15	0.3	16	● Red	500	9037450000
H1,0/22DS R ZH	1	AWG 17	22.00		2		0.15	0.3	21	● Red	500	9036330000
H1,0/25D ZH R	1	AWG 17	25.00	18	2		0.15	0.3	22	● Red	500	9037460000
H1,5/16D ZH SW	1.5	AWG 16	16.00	8	2.2		0.15	0.3	11	● Black	500	9037470000
H1,5/20D ZH SW	1.5	AWG 16	20.00	12	2.2		0.15	0.3	15	● Black	500	9037480000
H1,5/26D ZH SW	1.5	AWG 16	25.00	18	2.2		0.15	0.3	21	● Black	100	9037490000
H2,5/19D ZH BL	2.5	AWG 14	19.00	10	2.8		0.15	0.4	13	● Blue	500	9037500000
H2,5/21D ZH BL	2.5	AWG 14	21.00	12	2.8		0.15	0.4	15	● Blue	100	9037510000
H2,5/27D ZH BL	2.5	AWG 14	27.00	18	2.8		0.15	0.4	21	● Blue	100	9037520000
H4,0/22D ZH GR	4	AWG 12	22.00	12	3.5		0.2	0.5	15	● Grey	100	9037530000
H6,0/23D ZH GE	6	AWG 10	23.00	12	4.5		0.2	0.5	20	● Yellow	100	9037550000
H4,0/28D ZH GR	4	AWG 12	28.00	18	3.5		0.2	0.5	21	● Grey	100	9037540000
H6,0/29D ZH GE	6	AWG 10	29.00	18	4.5		0.2	0.5	24	● Yellow	100	9037560000
H10,0/24D ZH R	10	AWG 7	24.00	12	5.8		0.2	0.5	17	● Red	100	9037570000
H10,0/24DS ZH R	10	AWG 7	24.00	12	6.5		0.2	0.5	17	● Red	100	9018880000
H10,0/30D ZH R	10	AWG 7	30.00	18	5.8		0.2	0.5	23	● Red	100	9037580000
H10/30DS ZH R	10	AWG 7	30.00	18	6.5		0.2	0.5	23	● Red	100	9018890000
H16,0/29D ZH BL	16	AWG 6	29.00	16	8.3		0.3	0.6	20	● Blue	50	9037590000
H16,0/38D ZH BL	16	AWG 6	38.00	25	8.3		0.3	0.6	29	● Blue	50	9037600000

### DIN colour code

#### In multi-pack bag



Type	Ø mm <sup>2</sup>	AWG	L1	L2	D1	D2	S1	S2	Stripping length	Colour	Qty.	Order No.
H0,5/14D ZH	0.5	AWG 20	14.00	8	1.4		0.15	0.3	11	○ White	500	9004780000
H0,75/14D Z	0.75	AWG 18	14.00	8	1.7		0.15	0.3	11	● Grey	500	9018520000
H1,0/15D ZH	1	AWG 17	15.00	8	2.2		0.15	0.3	12	● Red	500	9018540000
H1,0/19D ZH	1	AWG 17	19.00	12	2		0.15	0.3	16	● Red	500	9004760000
H0,75/16D Z	0.75	AWG 18	16.00	10	1.7		0.15	0.3	13	● Grey	500	9004770000
H1,5/16D ZH	1.5	AWG 16	16.00	8	2.2		0.15	0.3	11	● Black	500	9004420000
H1,5/20D SW	1.5	AWG 16	20.00	12	2.2		0.15	0.3	15	● Black	500	9004750000
H2,5/19D ZH	2.5	AWG 14	19.00	10	2.8		0.15	0.4	13	● Blue	250	9004430000
H2,5/21D ZH	2.5	AWG 14	21.00	12	2.8		0.15	0.4	15	● Blue	250	9004740000
H4/22D ZH G	4	AWG 12	22.00	12	3.5		0.2	0.5	15	● Grey	100	9004730000
H6,0/23D ZH	6	AWG 10	23.00	12	4.5		0.2	0.5	20	● Yellow	100	9004720000
H10,0/26D R	10	AWG 7	26.00	12	5.8		0.2	0.5	17	● Red	100	9004710000



## Twin wire-end ferrules with plastic collars

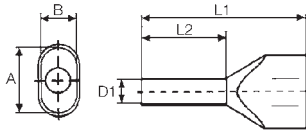

- Polypropylene conical entry funnel
- Heat-resistant up to 105°C
- The entry funnel can also be manufactured from a non-flammable material on request

For conductors of 2 x 0.5-2 x 16 mm<sup>2</sup> (2 x AWG 20-2 x AWG6)

Material E-Cu, electro-galvanised

Dimensional tolerance acc. to DIN 46228 Part 4

### Other colour code

#### Packed loose



Type	Ø mm <sup>2</sup>	AWG	L1	L2	D1	D2	S1	S2	Stripping length	Colour	Qty.	Order No.
H0,5/14 ZH OR	0.5	AWG 20	14.00	8	1.4		0.15	0.3	11	● Orange	500	9037200000
H0,5/16 ZH OR	0.5	AWG 20	16.00	10	1.4		0.15	0.3	13	● Orange	500	9037210000
H0,75/14T ZH HBL	0.75	AWG 18	14.00	8	1.7		0.15	0.3	11	● Light Blue	500	9037610000
H0,5/18 ZH OR	0.5	AWG 20	18.00	12	1.4		0.15	0.3	15	● Orange	500	9037220000
H0,75/16T ZH HBL	0.75	AWG 18	16.00	10	1.7		0.15	0.3	13	● Light Blue	500	9037620000
H0,75/19TS ZH HBL	0.75	AWG 18	19.00	12	1.7		0.15	0.3	21	● Light Blue	500	9202840000
H0,75/24T ZH HBL	0.75	AWG 18	24.00	18	1.7		0.15	0.3	21	● Light Blue	500	9037630000
H1,0/15D ZH R	1	AWG 17	15.00	8	2		0.15	0.3	11	● Red	500	9037440000
H1,0/19D ZH R	1	AWG 17	19.00	12	2		0.15	0.3	16	● Red	500	9037450000
H1,0/25D ZH R	1	AWG 17	25.00	18	2		0.15	0.3	22	● Red	500	9037460000
H1,5/16D ZH SW	1.5	AWG 16	16.00	8	2.2		0.15	0.3	11	● Black	500	9037470000
H1,5/20D ZH SW	1.5	AWG 16	20.00	12	2.2		0.15	0.3	15	● Black	500	9037480000
H1,5/26D ZH SW	1.5	AWG 16	25.00	18	2.2		0.15	0.3	21	● Black	100	9037490000
H2,5/19T ZH GR	2.5	AWG 14	19.00	10	2.8		0.15	0.4	13	● Grey	500	9037640000
H2,5/21T ZH GR	2.5	AWG 14	21.00	12	2.8		0.15	0.4	15	● Grey	100	9037650000
H2,5/27T ZH GR	2.5	AWG 14	27.00	18	2.8		0.15	0.4	21	● Grey	100	9037660000
H4,0/22T ZH OR	4	AWG 12	22.00	12	3.5		0.2	0.5	15	● Orange	100	9037670000
H4,0/28T ZH OR	4	AWG 12	28.00	18	3.5		0.2	0.5	21	● Orange	100	9037680000
H6,0/23T ZH GN	6	AWG 10	23.00	12	4.5		0.2	0.5	20	● Green	100	9037690000
H6,0/29T ZH GN	6	AWG 10	29.00	18	4.5		0.2	0.5	24	● Green	100	9037700000
H10,0/24T ZH BR	10	AWG 7	24.00	12	5.8		0.2	0.5	17	● Brown	100	9037710000
H10,0/30T ZH BR	10	AWG 7	30.00	18	5.8		0.2	0.5	23	● Brown	100	9037720000
H16,0/29T ZH W	16	AWG 6	29.00	16	8.3		0.3	0.6	20	○ White	50	9037730000
H16,0/38T ZH W	16	AWG 6	38.00	25	8.3		0.3	0.6	29	○ White	50	9037740000

### Other colour code

#### In multi-pack bag



Type	Ø mm <sup>2</sup>	AWG	L1	L2	D1	D2	S1	S2	Stripping length	Colour	Qty.	Order No.
H0,75/16T Z	0.75	AWG 18	16.00	10	1.7		0.15	0.3	13	● Light Blue	500	9005140000
H1,0/19D ZH	1	AWG 17	19.00	12	2		0.15	0.3	16	● Red	500	9018540000
H1,0/19D ZH	1	AWG 17	19.00	12	2		0.15	0.3	16	● Red	500	9004760000
H1,5/16D ZH	1.5	AWG 16	16.00	8	2.2		0.15	0.3	11	● Black	500	9004420000
H1,5/20D SW	1.5	AWG 16	20.00	12	2.2		0.15	0.3	15	● Black	500	9004750000
H2,5/19T ZH	2.5	AWG 14	19.00	10	2.8		0.15	0.4	13	● Grey	250	9018580000
H2,5/21 ZH	2.5	AWG 14	21.00	12	2.8		0.15	0.4	15	● Grey	250	9005150000
H4,0/22T ZH	4	AWG 12	2.00	12	3.5		0.2	0.5	15	● Orange	100	9018590000
H6,0/23T ZH	6	AWG 10	23.00	12	4.5		0.2	0.5	20	● Green	100	9005160000
H10,0/26T Z	10	AWG 7	26.00	12	5.8		0.2	0.5	17	● Brown	100	9005170000

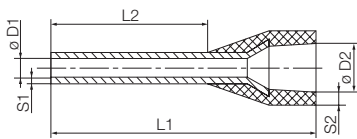

- Polypropylene conical entry funnel
- Heat-resistant up to 105 °C
- The entry funnel can also be manufactured from a non-flammable material on request

For conductors from 1.5-16 mm<sup>2</sup> (AWG 26-250MCM)

Material E-Cu, electro-galvanised

Dimensional tolerance acc. to DIN 46228 Part 4

**Weidmüller colour code**

**Packed loose**



Type	Ø mm <sup>2</sup>	AWG	L1	L2	D1	D2	S1	S2	Stripping length	Colour	Qty.	Order No.
H1,5/24 XS SW	1.5	AWG 16	24.00	14.5	1.8	6.8	0.15	0.3	13	● Black	100	9202870000
H2,5/24 XS BL	2.5	AWG 14	24.00	14.5	2.3	7.6	0.15	0.3	20	● Black	100	9202880000

**Weidmüller colour code**

**In multi-pack bag**



Type	Ø mm <sup>2</sup>	AWG	L1	L2	D1	D2	S1	S2	Stripping length	Colour	Qty.	Order No.
H1,5/17,5X	1.5	AWG 16	17.50	8	1.8	6.8	0.15	0.3	13	● Black	100	9006590000
H1,5/19,5X	1.5	AWG 16	19.50	10	1.8	6.8	0.15	0.3	15	● Black	100	9006630000
H2,5/17,5X	2.5	AWG 14	17.50	8	2.3	7.6	0.15	0.3	14	● Blue	100	9006670000
H2,5/21,5X	2.5	AWG 14	21.50	12	2.3	7.6	0.15	0.3	17	● Blue	100	9006710000
H4,0/19,5X	4	AWG 12	19.50	10	2.9	7.8	0.2	0.3	14	● Grey	100	9006750000
H6,0/23,0X	6	AWG 10	23.00	12	3.6	8.1	0.2	0.3	17	● Yellow	100	9006790000
H10,0/24,0X	10	AWG 7	24.00	12	4.6	9.6	0.2	0.3	17	● Red	100	9006830000
H16,0/25,5X	16	AWG 6	25.50	12	6	11.9	0.2	0.3	26	● Blue	100	9006870000

## Wire-end ferrules with plastic collars, special sizes

- Polypropylene conical entry funnel
- Heat-resistant up to 105°C
- The entry funnel can also be manufactured from a non-flammable material on request

For conductors from 0.5-2.5 mm<sup>2</sup> Material E-Cu, electro-galvanised  
Dimensional tolerance acc. to DIN 46228 Part 4

## Weidmüller colour code

## Packed loose



Type	Ø mm <sup>2</sup>	AWG	L1	L2	D1	D2	S1	S2	Stripping length	Colour	Qty.	Order No.
H0,34/11 S TK	0.34	AWG 22	11.00	6	0.85	2.6	0.15	0.4	6	Turquoise	500	9204090000
H0,5/14S OR	0.5	AWG 20	14.00	8	1	2.9	0.15	0.25	10	Orange	500	9004560000
H0,5/14S W	0.5	AWG 20	14.00	8	1	2.9	0.15	0.25	10	White	500	9004590000
H0,5/16 DS W	0.5	AWG 20	16.00	10	1	2.9	0.15	0.25	12	White	500	9202910000
H 0,5/16 S OR	0.5	AWG 20	16.00	10	1	2.9	0.15	0.25	12	Orange	500	9202900000
H0,75/14DS GR	0.75	AWG 18	14.00	8	1.2	3.4	0.15	0.25	10	Grey	500	9028580000
H0,75/14S W	0.75	AWG 18	14.00	8	1.2	3.4	0.15	0.25	10	White	500	9025960000
H0,75/14TS HBL	0.75	AWG 18	14.00	8	1.2	3.4	0.15	0.25	10	Light Blue	500	9018550000
H0,75/15S HBL	0.75	AWG 18	15.00	9	1.2	2.8	0.15	0.25	10	Light Blue	500	9204240000
H1,0/14S GE	1	AWG 17	14.00	8	1.4	3.5	0.15	0.25	10	Yellow	500	9025970000
H1,0/14S R	1	AWG 17	14.00	8	1.4	3.5	0.15	0.25	10	Red	500	9018560000
H1,5/12S R	1.5	AWG 16	12.00	6	1.7	3.9	0.15	0.25	8	Red	500	9025690000
H1,5/14S R	1.5	AWG 16	14.00	8	1.7	3.9	0.15	0.25	10	Red	500	9025980000
H1,5/14S SW	1.5	AWG 16	14.00	8	1.7	3.9	0.15	0.25	10	Black	500	9025240000
H2,5/12DS BL	2.5	AWG 14	12.00	6	2.2	4.2	0.15	0.25	8	Blue	500	9028490000
H2,5/12TS GR	2.5	AWG 14	12.00	6	2.2	4.2	0.15	0.25	8	Grey	500	9036200000
H2,5/14S BL	2.5	AWG 14	14.00	8	2.2	4	0.15	0.25	10	Blue	500	1333100000
H2,5/14TS GR	2.5	AWG 14	14.00	8	2.2	4	0.15	0.25	10	Grey	500	9426770000
H2,5/16DS BL	2.5	AWG 14	16.00	10	2.2	4.2	0.15	0.25	13	Blue	500	9036220000
H 4,0/20 DS GR	4	AWG 12	20.00	12	2.9	4.7	0.2	0.5	15	Grey	500	9203630000
H 10,0/22 S EB	10	AWG 7	22.00	12	4.6	7.1	0.2	0.6	15	Ivory	100	9203620000

## Weidmüller colour code

## In multi-pack bag



Type	Ø mm <sup>2</sup>	AWG	L1	L2	D1	D2	S1	S2	Stripping length	Colour	Qty.	Order No.
H0,75/14S W	0.75	AWG 18	14.00	8	1.2	3.4	0.15	0.25	10	White	500	9025700000
H1,0/14S GE	1	AWG 17	14.00	8	1.4	3.5	0.15	0.25	10	Yellow	500	9025710000
H1,5/14DS S	1.5	AWG 16	14.00	8	1.7	3.9	0.15	0.25	10	Black	500	9028360000
H1,5/14S R	1.5	AWG 16	14.00	8	1.7	3.9	0.15	0.25	10	Red	500	9025720000

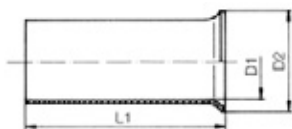

For conductors 0.25-185 mm<sup>2</sup> (AWG 24-350MCM) Material: tin-plated copper  
Dimensional tolerances to DIN 46228 part 1

**Without plastic collar**

**Packed loose**



Type	Ø mm <sup>2</sup>	AWG	L1	L2	D1	D2	S1	S2	Stripping length	Qty.	Order No.
H0,25/5	0.25	AWG 24	5.00		0.8	1.6			5	1000	9018910000
H0,5/10	0.5	AWG 20	10.00		1	2.1			10	1000	9004050000
H0,5/6	0.5	AWG 20	6.00		1	2.1			6	1000	0282600000
H0,75/10	0.75	AWG 18	10.00		1.2	2.3			10	1000	0542500000
H0,75/6	0.75	AWG 18	6.00		1.2	2.3			6	1000	0282700000
H1,0/10	1	AWG 17	10.00		1.4	2.5			10	1000	0282800000
H1,0/6	1	AWG 17	6.00		1.4	2.5			6	1000	0372600000
H1,5/10	1.5	AWG 16	10.00		1.7	2.8			10	1000	0186500000
H1,5/12	1.5	AWG 16	12.00		1.7	2.8			12	1000	9004060000
H1,5/18	1.5	AWG 16	18.00		1.7	2.8			18	1000	9004070000
H1,5/7	1.5	AWG 16	7.00		1.7	2.8			7	1000	0372700000
H2,5/10	2.5	AWG 14	10.00		2.2	3.4			10	1000	9004080000
H2,5/12	2.5	AWG 14	12.00		2.2	3.4			12	1000	0186100000
H2,5/18	2.5	AWG 14	18.00		2.2	3.4			18	1000	9004090000
H2,5/7	2.5	AWG 14	7.00		2.2	3.4			7	1000	0373000000
H4,0/12	4	AWG 12	12.00		2.8	4			12	1000	0244100000
H4,0/15	4	AWG 12	15.00		2.8	4			15	500	9004100000
H4,0/18	4	AWG 12	18.00		2.8	4			18	500	9004110000
H4,0/9	4	AWG 12	9.00		2.8	4			9	500	0373100000
H6,0/10	6	AWG 10	10.00		3.5	4.7			10	500	9004120000
H6,0/12	6	AWG 10	12.00		3.5	4.7			12	500	0191900000
H6,0/15	6	AWG 10	15.00		3.5	4.7			15	500	0124700000
H6,0/18	6	AWG 10	18.00		3.5	4.7			18	500	9004130000
H10,0/12	10	AWG 7	12.00		4.5	5.8			12	500	0282900000
H10,0/15	10	AWG 7	15.00		4.5	5.8			15	500	0124800000
H10,0/18	10	AWG 7	18.00		4.5	5.8			18	500	0379300000
H16,0/12	16	AWG 6	12.00		5.8	7.5			12	500	0492500000
H16,0/15	16	AWG 6	15.00		5.8	7.5			15	500	0124300000
H16,0/18	16	AWG 6	18.00		5.8	7.5			18	100	0375200000
H16,0/25	16	AWG 6	25.00		5.8	7.5			25	100	9004150000
H16,0/32	16	AWG 6	32.00		5.8	7.5			32	100	9004160000
H25,0/15	25	AWG 3	15.00		7.3	9.5			15	250	0124400000
H25,0/18	25	AWG 3	18.00		7.3	9.5			18	100	0375300000
H25,0/25	25	AWG 3	25.00		7.3	9.5			25	250	9004170000
H25,0/32	25	AWG 3	32.00		7.3	9.5			32	100	9004180000
H35,0/18	35	AWG 2	18.00		8.3	11			18	100	0368900000
H35,0/25	35	AWG 2	25.00		8.3	11			25	100	9004190000
H35,0/30S	35	AWG 2	30.00		8.3	11			30	100	9451000000
H35,0/32	35	AWG 2	32.00		8.3	11			32	100	9004200000
H50,0/18	50	AWG 1	18.00		10.3	13			18	100	9004210000
H50,0/22S	50	AWG 1	22.00		10.3	13			22	100	9025880000
H50,0/32	50	AWG 1	32.00		10.3	13			32	100	9004220000
H70,0/25	70	AWG 2/0	25.00		12.5	15			25	50	9004230000
H70,0/32	70	AWG 2/0	32.00		12.5	15			32	50	9004240000
H95,0/25	95	AWG 3/0	25.00		14.5	17			25	50	9004250000
H95,0/32	95	AWG 3/0	32.00		14.5	17			32	50	9004260000
H120,0/32	120	AWG 4/0	32.00		16.5	19			32	25	9036240000
H150,0/32	150	AWG 300 MCM	32.00		18.5	21			32	25	9036250000
H185,0/32	185	AWG 350 MCM	32.00		20	23.5			32	25	9036260000

**Assortment of wire-end ferrules**

**0.14...0.75 mm<sup>2</sup>**



Box filled with wire-end ferrules with plastic collar:

- in Weidmüller colour code

**0.5...2.5 mm<sup>2</sup>**



Box filled with wire-end ferrules with plastic collar:

- in Weidmüller colour code
- DIN colour code

**ZH 0.5...2.5 mm<sup>2</sup>**



Box filled with twin wire-end ferrules with plastic collars:

- in Weidmüller colour code

**Assembly**

Type		Piece
H0,14/10 GR SV	Wire end ferrule	500
H0,25/10 HBL	Wire end ferrule	500
H0,34/10 TK	Wire end ferrule	500
H0,5/14 OR	Wire end ferrule	500
H0,75/14 W	Wire end ferrule	500

**Assembly**

Type		Piece
H1,0/14 GE	Wire end ferrule	500
H1,5/14 R	Wire end ferrule	500
H0,5/14D W	Wire end ferrule	500
H0,75/14D GR	Wire end ferrule	500
H2,5/15D BL	Wire end ferrule	500

**Assembly**

Type		Piece
H0,5/14 ZH OR	Wire end ferrule	500
H0,75/14 ZH W	Wire end ferrule	500
H1,0/15 ZH GE	Wire end ferrule	500
H1,5/16 ZH R	Wire end ferrule	500
H2,5/19D ZH BL	Wire end ferrule	500

**Technical data**

Diameter / Height	92 mm / 25 mm
Weight	93 g

**Technical data**

Diameter / Height	92 mm / 40 mm
Weight	93 g

**Technical data**

Diameter / Height	92 mm / 40 mm
Weight	93 g

**Ordering data**

Colour code	Type	Order No.
Weidmüller	H-BOX 0,14-0,75QMM	9025410000

**Ordering data**

Colour code	Type	Order No.
Weidmüller	H-BOX 0,5-2,5QMM	9025900000
DIN	H-BOX 0,5-2,5QMM DIN	9025430000
Misc.	H-BOX 0,5-2,5QMM T	9023090000

**Ordering data**

Colour code	Type	Order No.
Weidmüller	ZH-BOX 0,5-2,5QMM	9025390000

4.0...16 mm<sup>2</sup>

Empty box



Box filled with wire-end ferrules with plastic collars:

- in Weidmüller colour code
- DIN colour code

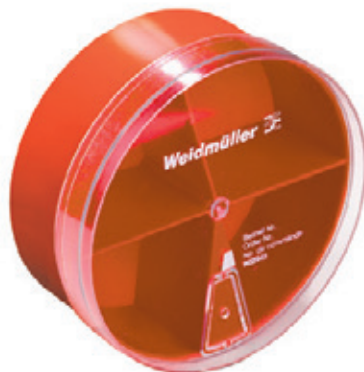

Empty box for wire-end ferrules with

- 4 dividers
- 5 dividers
- 5 coloured inserts

Assembly

Type		Piece
H6,0/20 SW	Wire end ferrule	100
H10,0/22 EB	Wire end ferrule	100
H16,0/22 GN	Wire end ferrule	100
H4/17 GRAU	Wire end ferrule	500

Technical data

Diameter / Height	92 mm / 40 mm
Weight	93 g

Ordering data

Colour code	Type	Order No.
Weidmüller	H-BOX 4,0-16,0QMM	9025920000
DIN	H-BOX 4,0-16,0QMM DIN	9025400000

Technical data

Diameter / Height	92 mm / 40 mm
Weight	

Ordering data

Colour code	Type	Order No.
Empty box	H-LEERBOX 4 TRENNSTEGE	9025420000
Empty box	H-LEERBOX 5 EINSATZTE	9025940000
Empty box	H-LEERBOX 5 TRENNSTEGE	9025680000

**Insulated cable connectors, PVC, with conical cable entry**



**Ring cable connector**



**Ordering data**

Type	Cross-section mm <sup>2</sup>	Colour	Dimensions	d <sup>1</sup>	d	D	L	b	S1*	Qty.	Order No.
LIR 1.5M3 V	0.5 - 1.5	●	M 3	3.2	5.5	4.0	16.05	11.3	0.75	100	9200070000
LIR 1.5M3.5 V	0.5 - 1.5	●	M 3.5	3.7	5.5	4.0	16.05	11.3	0.75	100	9200080000
LIR 1.5M4 V	0.5 - 1.5	●	M 4	4.3	8.0	4.0	18.3	11.3	0.75	100	9200090000
LIR 1.5M5 V	0.5 - 1.5	●	M 5	5.3	8.0	4.0	18.3	11.3	0.75	100	9200100000
LIR 1.5M6 V	0.5 - 1.5	●	M 6	6.4	11.6	4.0	21.0	11.3	0.75	100	9200110000
LIR 1.5M8 V	0.5 - 1.5	●	M 8	8.4	11.6	4.0	21.0	11.3	0.75	100	9200120000
LIR 2.5M3 V	1.5 - 2.5	●	M 3	3.2	6.4	4.5	15.6	11.3	0.8	100	9200150000
LIR 2.5M3.5 V	1.5 - 2.5	●	M 3.5	3.7	6.4	4.5	15.6	11.3	0.8	100	9200160000
LIR 2.5M4 V	1.5 - 2.5	●	M 4	4.4	8.5	4.5	19.05	11.3	0.8	100	9200170000
LIR 2.5M5 V	1.5 - 2.5	●	M 5	5.3	8.5	4.5	19.05	11.3	0.8	100	9200180000
LIR 2.5M6 V	1.5 - 2.5	●	M 6	6.4	12.0	4.5	22.3	11.3	0.8	100	9200190000
LIR 2.5M8 V	1.5 - 2.5	●	M 8	8.4	12.0	4.5	22.3	11.3	0.8	100	9200200000
LIR 2.5M10 V	1.5 - 2.5	●	M 10	10.5	14.0	4.5	22.3	11.3	0.8	100	9200210000
LIR 6.0M4 V	4 - 6	●	M 4	4.3	9.5	6.4	22.4	14.15	1	100	9200230000
LIR 6M5 V	4 - 6	●	M 5	5.3	9.5	6.4	22.4	14.15	1	100	9200240000
LIR 6M6 V	4 - 6	●	M 6	6.4	12.0	6.4	24.65	14.15	1	100	9200250000
LIR 6M8 V	4 - 6	●	M 8	8.4	15.0	6.4	27.65	14.15	1	100	9200260000
LIR 6.0M10 V	4 - 6	●	M 10	10.5	15.0	6.4	27.65	14.15	1	100	9200270000

**Fork-type cable connector**



**Ordering data**

Type	Cross-section mm <sup>2</sup>	Colour	Dimensions	d <sup>1</sup>	d	D	L	b	S1*	Qty.	Order No.
LIS 1.5M3 V	0.5 - 1.5	●	M 3	3.2	5.7	4.0	17.8	11.3	0.75	100	9200290000
LIS 1.5M3.5 V	0.5 - 1.5	●	M 3.5	3.7	6.4	4.0	17.8	11.3	0.75	100	9200300000
LIS 1.5M4 V	0.5 - 1.5	●	M 4	4.3	7.2	4.0	17.8	11.3	0.75	100	9200310000
LIS 1.5M5 V	0.5 - 1.5	●	M 5	5.3	8.1	4.0	17.8	11.3	0.75	100	9200320000
LIS 1.5M6 V	0.5 - 1.5	●	M 6	6.4	11.0	4.0	21.3	11.3	0.75	100	9200330000
LIS 2.5M3 V	1.5 - 2.5	●	M 3	3.2	5.7	4.5	17.8	11.3	0.8	100	9200350000
LIS 2.5M3.5 V	1.5 - 2.5	●	M 3.5	3.7	6.4	4.5	17.8	11.3	0.8	100	9200360000
LIS 2.5M4 V	1.5 - 2.5	●	M 4	4.3	7.2	4.5	17.8	11.3	0.8	100	9200370000
LIS 2.5M5 V	1.5 - 2.5	●	M 5	5.3	8.1	4.5	17.8	11.3	0.8	100	9200380000
LIS 2.5M6 V	1.5 - 2.5	●	M 6	6.4	11.0	4.5	21.3	11.3	0.8	100	9200390000
LIS 6.0M4 V	4 - 6	●	M 4	4.3	9.0	6.4	21.35	14.15	1	100	9200410000
LIS 6.0M5 V	4 - 6	●	M 5	5.3	9.0	6.4	21.35	14.15	1	100	9200420000
LIS 6.0M6 V	4 - 6	●	M 6	6.4	12.0	6.4	25.15	14.15	1	100	9200430000
LIS 6.0M8 V	4 - 6	●	M 8	8.4	14	6.5	34	13.15	1	100	9200440000
LIS 6.0M10 V	4 - 6	●	M 10	10.5	18	6.5	34.7	13.15	1	100	9200450000

S1\* = Connection density

**Pin-type cable connector**



**Ordering data**

Type	Cross-section mm <sup>2</sup>	Colour	Dimensions	D	L	b	f	Qty.	Order No.
LIP 1.5R12 V	0.5 - 1.5	●	12.0	4	23.3	11.3	1.9	100	9200460000
LIP 2.5R12 V	1.5 - 2.5	●	12.0	4.5	23.3	11.3	1.9	100	9200470000
LIP 6.0R14 V	4 - 6	●	14.0	6.4	28.15	14.5	2.7	100	9200480000

**Hook-type cable connector**

to ESI 50-18 part 2

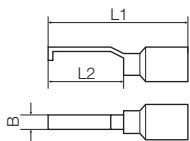

**Ordering data**

Type	Cross-section mm <sup>2</sup>	Colour	L1	L2	B	Qty.	Order No.
HB 1-17	0.25 - 1.5	●	27.2	16.75	4.6	100	9036290000
HB 1-13	1.0 - 2.5	●	27.2	16.75	3.0	100	9036300000



**Butt connector**



**Ordering data**

Type	Cross-section mm <sup>2</sup>	Colour	Dimensions	D	L	Qty.	Order No.
LIB 1.5B25 VF	0.5 - 1.5	●	24.5	3.8	26	100	9200490000
LIB 2.5B25 VF	1.5 - 2.5	●	24.5	4.3	26	100	9200500000
LIB 6.0B26 VF	4 - 6	●	26.0	6	26	100	9200510000

**Flat blade receptacles**

with copper sleeve

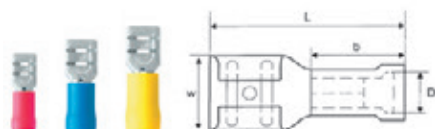

**Ordering data**

Type	Cross-section mm <sup>2</sup>	Colour	Dimensions	d2*	d3*	D	L	b	w	Qty.	Order No.
LIF 1.5F288 R	0.5 - 1.5	●	2.8 x 0.8 mm	2.8	0.8	4.0	18.7	10.0	3.8	100	9200520000
LIF 1.5F488 R	0.5 - 1.5	●	4.8 x 0.8 mm	4.8	0.8	4.0	19.2	10.0	5.7	100	9200530000
LIF 1.5F638 R	0.5 - 1.5	●	6.3 x 0.8 mm	6.3	0.8	4.0	20.8	10.0	7.4	100	9200540000
LIF 2.5F488 R	1.5 - 2.5	●	4.8 x 0.8 mm	4.8	0.8	5.0	19.2	10.0	5.7	100	9200550000
LIF 2.5F638 R	1.5 - 2.5	●	6.3 x 0.8 mm	6.3	0.8	5.0	20.8	10.0	7.4	100	9200560000
LIF 6.0F638 R	4 - 6	●	6.3 x 0.8 mm	6.3	0.8	6.8	23.8	13.0	7.4	100	9200570000

**Flat blade connector**

with copper sleeve



**Ordering data**

Type	Cross-section mm <sup>2</sup>	Colour	Dimensions	d2*	d3*	D	L	b	w	Qty.	Order No.
LIF 1.5M638 R	0.5 - 1.5	●	6.3 x 0.8 mm	6.3	0.8	4.0	20.8	10.0	6.3	100	9200580000
LIF 2.5M638 R	1.5 - 2.5	●	6.3 x 0.8 mm	6.3	0.8	5.0	20.8	10.0	6.3	100	9200590000
LIF 6.0M638 R	4 - 6	●	6.3 x 0.8 mm	6.3	0.8	6.8	23.8	13.0	6.3	100	9200600000

**Flat blade receptacles, piggy-back**

with copper sleeve



**Ordering data**

Type	Cross-section mm <sup>2</sup>	Colour	Dimensions	d2*	d3*	D	L	b	w	Qty.	Order No.
LIF 1.5T638 R	0.5 - 1.5	●	6.3 x 0.8 mm	6.3	0.8	4.0	20.8	10.0	7.4	100	9200610000
LIF 2.5T638 R	1.5 - 2.5	●	6.3 x 0.8 mm	6.3	0.8	5.8	20.8	10.0	7.4	100	9200620000
LIF 6.0T638 R	4 - 6	●	6.3 x 0.8 mm	6.3	0.8	6.8	23.8	13.0	7.4	100	9200630000

**Flat blade receptacles, full insulation**

with copper sleeve

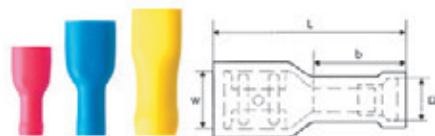

**Ordering data**

Type	Cross-section mm <sup>2</sup>	Colour	Dimensions	d2*	d3*	D	L	b	w	Qty.	Order No.
LIF 1.5F638 RF	0.5 - 1.5	●	6.3 x 0.8 mm	6.3	0.8	4.0	22.0	10.5	7.4	100	9200640000
LIF 2.5F638 RF	1.5 - 2.5	●	6.3 x 0.8 mm	6.3	0.8	5.0	22.0	10.5	7.4	100	9200650000
LIF 6.0F638 RF	4 - 6	●	6.3 x 0.8 mm	6.3	0.8	6.8	24.5	13.0	5.7	100	9200660000

d2\* = Plug-in width  
d3\* = Plug-in density



**Insulated cable connectors, PVC, with conical cable entry**



**Round plug**

with copper sleeve

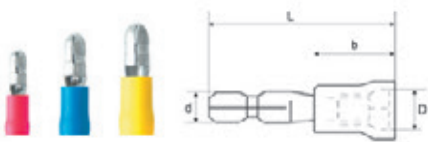

**Ordering data**

Type	Cross-section mm <sup>2</sup>	Colour	Dimensions	d	D	L	b	Qty.	Order No.
LID 1,5M4 R	0,5 - 1,5	●	Ø 4 mm	4,0	4,0	20,8	10,0	100	9200670000
LID 2,5M5 R	1,5 - 2,5	●	Ø 5 mm	5,0	5,0	20,8	10,0	100	9200680000
LID 6,0M5 R	4 - 6	●	Ø 5 mm	5,0	5,8	23,8	13,0	100	9200690000

**Sockets for round plugs**

with copper sleeve

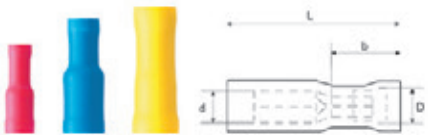

**Ordering data**

Type	Cross-section mm <sup>2</sup>	Colour	Dimensions	d	D	L	b	Qty.	Order No.
LID 1,5F4 RF	0,5 - 1,5	●	Ø 4 mm	4,0	4,0	23,0	10,5	100	9200700000
LID 2,5F5 RF	1,5 - 2,5	●	Ø 5 mm	5,0	5,0	23,0	11,5	100	9200710000
LID 6,0F5 RF	4 - 6	●	Ø 5 mm	5,0	5,0	24,0	13,8	100	9200720000

# Cable lugs and insulated connectors

<b>Cable lugs and insulated connectors</b>	Technical data / general notes	K.2
	Tubular cable lugs, copper, euro-series	K.8
	Tubular cable lugs with angle, copper, euro-series	K.12
	Joint connector, copper, euro-series	K.15
	Crimp cable lugs, copper, DIN 46235	K.16
	Tubular compression connectors, copper, DIN 46267 part 1	K.19
	Terminals ring and fork-type, noninsulated	K.20
	Pin cable lugs DIN 46230, noninsulated	K.24
	Parallel connectors and joint connector, noninsulated	K.25
	Terminals ring type	K.26
	Terminals fork type	K.28
	Pin cable lugs / joint connector	K.29
	Parallel connectors / closed end connectors	K.30
	Cable-lug sleeves	K.31
	Cable lug connector / piggy back disconnectors	K.32
	Flag female disconnectors / circular plug	K.33
	Round-plug sleeves	K.34
	Hook-type cable lug	K.35

# Cable lugs and insulated connector

## Technical data / general information

### Temperature resistance

Copper-cable lugs and -connectors without insulation	up to max. 120°C (according to DIN 46 234)
Copper-cable lugs and -connectors with pa-insulation	-55 °C to +120 °C
Copper-cable lugs and -connectors with PC-insulation	-40 °C to +120 °C
Butt-connectors with shrink insulation	-10 °C to +105 °C
Terminals with PVC (polyvinyl chloride) insulation	-10 °C to +70 °C
Terminals with PC (polycarbonate=makrolon) insulation	-40 °C to +100 °C
Terminals with PA (polyamide)-insulation	-55 °C to +100 °C
Brass terminals, tin plated, without insulation	-55 °C to +100 °C

### Conductor cross section comparison

comparable ISO-cross section in (mm <sup>2</sup> )	AWG/ MCM	
	AWG	cross section (mm <sup>2</sup> )
0.14	26	0.128
0.2	24	0.205
0.34	22	0.325
0.5	20	0.519
0.75	18	0.823
1	-	-
1.5	16	1.31
2.5	14	2.08
4	12	3.31
6	10	5.27
10	8	8.35
16	6	13.3
25	4	21.2
35	2	33.6
-	1	42.4
50	0	53.4
70	00	67.5
95	000	85.0
-	0000	107.2
120	250 MCM	127
150	300 MCM	152
185	350 MCM	177
240	500 MCM	253
300	600 MCM	304

### Silicone and halogen concentration of insulated connecting material

The following chart shows the concentration of silicone and halogen of insulated connection material delivered by us:

Article description	free of silicone	free of halogen
Terminals, ring type	yes	yes
Terminals, fork type	yes	yes
Pin cable lugs	yes	yes
Joint connector	yes	yes
Parallel-connectors	yes	yes
Joint connector heat shrink insulation	yes	yes
Closed end connectors	yes	yes
Cable-lug sleeves and cable-lug sleeves PVC - insulated	yes	no
Cable-lug sleeves and cable-lug sleeves PC - insulated	yes	yes
Cable-lug sleeves tin-bronze PA - insulated	yes	yes
Cable-lug sleeves , fully insulated	yes	yes
Piggy back disconnectors PVC - insulated	yes	no
Piggy back disconnectors PC - insulated	yes	yes
Flag female disconnectors	yes	yes
Round-plug sleeves PVC - insulated	yes	no
Circular plug PVC - insulated	yes	no
Circular plug PC - insulated	yes	yes
Round-plug sleeves and circular plug, fully insulated	yes	yes

### Colour of insulation

cross section mm <sup>2</sup>	colour
0.1 - 0.5	yellow
0.5 - 1	red
1.5 - 2.5	blue
4 - 6	yellow
10	red
16	blue
25	yellow
35	red
50	blue
70	yellow
95	red
120	blue
150	yellow

**Electrical characteristics**

Maximum allowable current load of cable lugs and connectors  
in conjunction with insulated conductors (at ambient temperature +30 °C)

nominal cross section (mm <sup>2</sup> )	Single cor cable	Multicore cables + cords, excl. home- and portable apparatus	Multicore heavy duty rubber cables
	- rubber insulated - PVC insulated - TPE insulated - heat resistant	- rubber insulated - PVC insulated - TPE insulated - heat resistant	min. 0.6 / 1kV
	Cu (A)	Cu (A)	Cu (A)
0.75	15	12	-
1	19	15	-
1.5	24	18	23
2.5	32	26	30
4	42	34	41
6	54	44	53
10	73	61	74
16	98	82	99
25	129	108	131
35	158	135	162
50	198	168	202
70	245	207	250
95	292	250	301
120	344	292	-
150	391	335	-
185	448	382	-
240	528	453	-
300	608	523	-
sources of current ratings:	DIN VDE 0298-4. 2003-08 Table 11, colonne 2	DIN VDE 0298-4. 2003-08 Table 11, colonne 5	DIN VDE 0298-4. 2003-08 Table 15, colonne 4+2

**Note:**

Design of these tables deviates from VDE 0298-4 design.  
In case of doubt, appliance of the current issue of the DIN VDE 0298-4 is obligatory.

Above Table values have to be taken into consideration of further applicable converting / derating factors:

- other ambient temperatures: DIN VDE 0298-4
- pay attention to the maximum electric current of the used equipment
- pay attention to the maximum current load of the used cable under consideration of the laying procedure



## Assembly of cable lugs and connectors general

1. Take the measurements of the cable lugs / connectors and their allocation of cross section out of this catalogue.
2. Cut the cable right-angled to the conductor. Strip off the insulation of the cable. The part to be stripped of has to be as long as the sleeve (measurement a) of the cable lug / connector + about 10 %.
3. Before crimping clean the conductor with a wire brush in order to remove dirt and oxidation. Sectorshaped conductors must be rounded before crimping!
4. Insert the noninsulated conductor into the compression sleeve until it reaches the wire stop.
5. Before starting to crimp please check whether conductor and cable lug respectively connector have the same cross section and do fit to each other according to our catalogue.
6. Please check whether crimping tool and crimping dies are suitable for the cable lugs/connectors you want to crimp. You can take this information for each series and cross section from the manufacturer's catalogue or the operating instructions of the tool.
7. The crimping process is evaluated, on the cable lug and connector, from the cable end to the end of the sleeve.(see illustration).

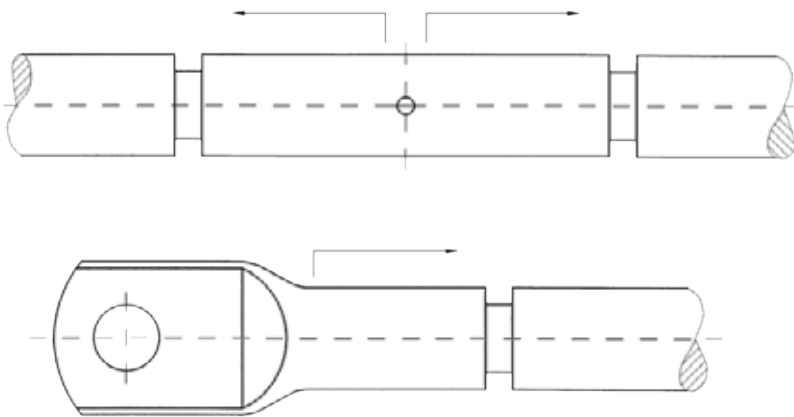

For the quantity of crimpings take notice of the preceding charts.  
(These you are able to find on the following page)

# Traction - specified value

cross section mm <sup>2</sup>	Values for crimpings up to 10 mm <sup>2</sup> (except end ferrules) (EN 60352 part 2 release 10/2002)			Values for aluminium crimpings from 16 mm <sup>2</sup> (VDE 0220 part 100 cross-section x 40)		
	traction 100 %	130 %	150 %	traction 100 %	130 %	150 %
0,2				28 N		
0,34				40 N		
0,5	60 N	78 N	90 N	56 N		
0,75	85 N	111 N	128 N	84 N		
1	108 N	140 N	162 N	108 N		
1,5	150 N	195 N	225 N	150 N		
2,5	230 N	299 N	345 N	230 N		
4	310 N	403 N	465 N	310 N		
6	360 N	468 N	540 N	360 N		
10	380 N	494 N	570 N			
	Values for copper crimpings from 10 mm <sup>2</sup> DIN EN 61238-1 release 3/2004 except end ferrules (VDE 0220 part 100 cross-section x 60) calculation:			Values for aluminium crimpings from 16 mm <sup>2</sup> (VDE 0220 part 100 cross-section x 40) calculation:		
	traction 100 %	130 %	150 %	traction 100 %	130 %	150 %
10	600 N	780 N	900 N	640 N	832 N	960 N
16	960 N	1.248 N	1.440 N	1.000 N	1.300 N	1.500 N
25	1.500 N	1.950 N	2.250 N	1.400 N	1.820 N	2.100 N
35	2.100 N	2.730 N	3.150 N	2.000 N	2.600 N	3.000 N
50	3.000 N	3.900 N	4.500 N	2.800 N	3.640 N	4.200 N
70	4.200 N	5.490 N	6.300 N	3.800 N	4.940 N	5.700 N
95	5.700 N	7.410 N	8.550 N	4.800 N	6.240 N	7.200 N
120	7.200 N	9.360 N	10.800 N	6.000 N	7.800 N	9.000 N
150	9.000 N	11.700 N	13.500 N	7.400 N	9.620 N	11.100 N
185	11.100 N	14.430 N	16.650 N	9.600 N	12.480 N	14.400 N
240	14.400 N	18.720 N	21.600 N	12.000 N	15.600 N	18.000 N
300	18.000 N	23.400 N	27.000 N	16.000 N	20.800 N	24.000 N
400	24.000 N*			20.000 N	26.000 N	30.000 N
500	30.000 N*			25.000 N*		
625	37.500 N*			32.000 N*		
800	48.000 N*					
1.000	60.000 N*					

Note: \* The maximum value of VDE 2002 T100 is 20.000 N!

To pass the test according to the norm, the conductor in the crimping connection may not slide by 100 % of the traction during 60 seconds holding time.

# Crimping instructions for euro-series

## Crimping instructions

Minimum necessary crimping quantity of cable lugs and connectors for euro-series. (WM-crimping):

## Crimping tools and order numbers

Cross section in mm	crimping quantity x width	PZ RK 6/70 1500440000	PZ RK 10/120 1500450000	MTR 35 9017500000	MTR 110 9018020000	EPG 45 1500830000	HPG 55 1501400000	APG 55 1501390000	HPG 80 1502420000	APG 80 1502390000
6	1 x 5 mm									
	1 x 7 mm									
10	1 x 5 mm									
	1 x 7 mm									
16	2 x 5 mm									
	1 x 7 mm									
25	2 x 5 mm									
	1 x 12 mm									
35	2 x 5 mm									
	1 x 10 mm									
	1 x 12 mm									
50	2 x 5 mm									
	1 x 12 mm									
70	2 x 5 mm									
	1 x 12 mm									
95	2 x 5 mm									
	1 x 12 mm									
120	3 x 5 mm									
	2 x 7 mm									
	1 x 10 mm									
150	3 x 5 mm									
	2 x 7 mm									
185	3 x 5 mm									
	2 x 7 mm									
	2 x 10 mm									
240	3 x 5 mm									
	3 x 7 mm									
	2 x 10 mm									
300	4 x 5 mm									
	3 x 7 mm									
	2 x 13 mm									

# Crimping instructions for DIN 46235-series and DIN 46267-series

## Crimping instructions

Minimum necessary crimping quantity of cable lugs and connectors  
for DIN 46235-series and DIN 46267-series (Hexagonal-shape-crimping):

## Crimping tools and order numbers

cross section in mm	die code	crimping quantity x width	PZ PK 6/70 1500470000	PZ PK 10/120 1500480000	MTR 35 9017500000	MTR 110 9018020000	EPG 45 1500830000	HPG 55 1501400000	APG 55 1501390000	HPG 80 1502420000	APG 80 1502390000
6	5	1 x 5 mm									
		1 x 7 mm									
10	6	1 x 5 mm									
		1 x 7 mm									
16	8	2 x 5 mm									
		1 x 12 mm									
25	10	2 x 5 mm									
		1 x 12 mm									
35	12	2 x 5 mm									
		1 x 10 mm									
		1 x 12 mm									
50	14	3 x 5 mm									
		1 x 12 mm									
70	16	3 x 5 mm									
		1 x 12 mm									
95	18	3 x 5 mm									
		4 x 5 mm									
		2 x 10 mm									
120	20	3 x 5 mm									
		4 x 5 mm									
		2 x 10 mm									
150	22	4 x 5 mm									
		2 x 10 mm									
185	25	4 x 5 mm									
		2 x 10 mm									
240	28	4 x 5 mm									
		2 x 13 mm									
300	32	4 x 5 mm									
		4 x 7 mm									
		2 x 13 mm									



# Tubular cable lugs and connectors, copper euro-series



K

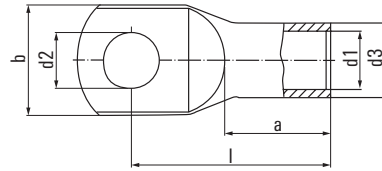

**Tubular cable lugs 0.5 – 25 mm<sup>2</sup>,  
euro-series**

**Technical data**

Material: Cu according to DIN EN 13600  
Surface: tin plated  
Approvals:



**Ordering data**

Cross-section mm <sup>2</sup>	flat hole M	dimensions in mm						Qty. (pcs.)	Order No.	Tool recommendation
		d1	d3	d2	b	l	a			
0.5 – 0.75	3	1.4	3	3.2	6.5	12.5	6	1495010000*	HTN 21	
	4			4.3	8.5	14		1495020000*		
	5			5.3	10	15		1495030000*		
1.0 – 1.5	3	1.9	3.9	3.2	6.5	14	6	1495040000*		
	4			4.3	8.5	15		1495050000*		
	5			5.3	10	16		1495070000*		
	6			6.4	11	18		1495080000*		
2.5	4	2.4	4.4	4.3	8.5	15	6.5	1495090000*		
	5			5.3	10	16		1495100000*		
	6			6.4	11	18		1495110000*		
	8			8.4	13	20		1495120000*		
4	4	3	5	4.3	8.5	17	8	1495130000*		
	5			5.3	10	18		1495140000*		
	6			6.4	11	20		1495150000*		
	8			8.4	14	22		1495170000*		
6	4	3.5	6.5	4.3	10	19	9	1497150000		
	5			5.3	10	20		1497170000		
	6			6.4	11	21.5		1497180000		
	8			8.4	15	24		1497190000		
	10			10.5	18	26		1497200000		
	12			13	19	27.5		1497210000		
10	4	4.5	7	4.3	12	20	10	1496900000		
	5			5.3	12	21		1496910000		
	6			6.4	12	22.5		1496920000		
	8			8.4	15	25		1496930000		
	10			10.5	18	27		1496940000		
	12			13	20	28.5		1496950000		
16	5	5.5	8.5	5.3	12	25		1496970000		
	6			6.4	12	26.5		1496980000		
	8			8.4	15	29		1496990000		
	10			10.5	18	31		1497000000		
	12			13	19	32		1497010000		
25	5	7	10	5.3	15	33.5	15	1495830000		
	6			6.4	15	31.5		1496490000		
	8			8.4	16	33		1496500000		
	10			10.5	18	34.5		1496510000		
	12			13	20	36		1496520000		
	14			15	22	39		1496530000		

\* UL not tested

Tubular cable lugs, copper, euro-series

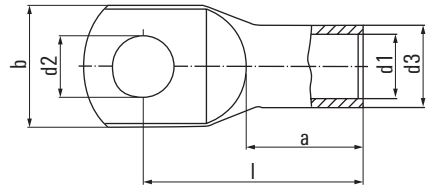

Tubular cable lugs 35 – 300 mm<sup>2</sup>, euro-series

Technical data

Material: Cu according to DIN EN 13600  
 Surface: tin plated  
 Approvals:



Ordering data

Cross section mm <sup>2</sup>	flat hole M	dimensions in mm						weight 100 pcs./kg	Qty (pcs.)	Order No.	Tool recommendation	
		d1	d3	d2	b	l	a					
35	6	8.5	12	6.4	17	33	17	2.07	100	1496540000	PZ PK 6/70 + PZ RK 10/120	EPG 45 APG 80 + HPG 80, EPG 45 APG 55 + HPG 55
	8			8.4	17	34		2.18	100	1496550000		
	10			10.5	20	36.5		2.19	100	1496570000		
	12			13	22	37.5		2.33	100	1496580000		
50	6	10	14	6.4	20	37	19	3.01	100	1496590000		
	8			8.4	20	39		3.04	100	1496600000		
	10			10.5	20	40.5		3.13	100	1496610000		
	12			13	23	42		3.13	100	1496620000		
	14			15	23	44		3.51	100	1495750000		
	16			17	27	46		3.55	100	1496630000		
70	6	12	16.5	6.4	24	40.5	21	4.11	25	1496640000		
	8			8.4	24	42.5		4.46	25	1496650000		
	10			10.5	24	43.5		4.64	25	1496670000		
	12			13	24	45		4.73	25	1495570000		
	14			15	25	46		4.91	25	1495770000		
	16			17	28	48.5		4.96	25	1495580000		
95	6	13.5	18	6.4	26	43	23	4.95	25	1495820000		
	8			8.4	26	46		5.36	25	1495600000		
	10			10.5	26	47		5.51	25	1495610000		
	12			13	26	48		5.51	25	1495620000		
	14			15	26	51.5		5.89	25	1495780000		
	16			17	28	51		5.85	25	1495630000		
120	6	15	20	6.4	26	43	23	6.13	25	1495640000		
	8			8.4	29	49.5	26	6.88	25	1495790000		
	10			10.5	29	52		7.99	25	1495650000		
	12			13	29	51.5		7.84	25	1495670000		
	14			15	30	53		7.86	25	1495800000		
	16			17	30	55		8.07	25	1495680000		
150	6	15	20	6.4	26	43	23	8.90	25	1495690000		
	8			8.4	29	49.5	26	8.88	25	1495790000		
	10			10.5	29	52		7.99	25	1495650000		
	12			13	29	51.5		7.84	25	1495670000		
	14			15	30	53		7.86	25	1495800000		
	16			17	30	55		8.07	25	1495680000		
185	8	16.8	21.3	8.4	29	49.5	26	8.90	25	1495690000		
	10			10.5	29	52		7.99	25	1495650000		
	12			13	29	51.5		7.84	25	1495670000		
	14			15	31	57		8.30	25	1495810000		
	16			17	31	58		8.36	25	1495730000		
	20			21	35	63		8.75	25	1495740000		
240	8	19	24	8.4	31	55.5	29	10.37	25	1497290000*		
	10			10.5	31	56.5		8.37	25	1495710000		
	12			13	31	56		8.07	25	1495720000		
	14			15	31	57		8.30	25	1495810000		
	16			17	31	58		8.36	25	1495730000		
	20			21	35	63		8.75	25	1495740000		
300	8	19	24	8.4	35	58	30	10.37	25	1497290000*		
	10			10.5	35	59		10.61	25	1495430000		
	12			13	35	58.5		10.60	25	1495440000		
	14			15	35	61		10.72	25	1497250000		
	16			17	35	63		10.86	25	1495450000		
	20			21	35	66		11.33	25	1495470000		
240	8	21	26	8.4	38	67	35	12.40	25	1495480000*		
	10			10.5	38	67		12.97	25	1495490000		
	12			13	38	67		13.02	25	1495500000		
	14			15	38	69		13.36	25	1497270000		
	16			17	38	69.5		13.56	25	1495510000		
	20			21	38	71		13.80	25	1495520000		
300	10	24	30	10.5	44	79.5	42	20.45	20	1495530000*		
	12			13	44	82		21.18	20	1495540000		
	14			15	44	84		22.19	20	1497280000		
	16			17	44	85		21.94	20	1495550000		
	20			21	44	85		22.40	20	1497240000		

\* UL not tested

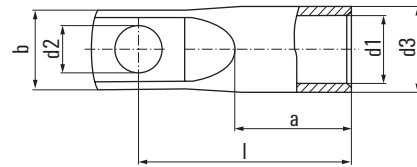

**Tubular cable lugs 35 – 300 mm<sup>2</sup>, euro-series, with narrow flange**

**Technical data**

Material: Cu according to DIN EN 13600  
 Surface: tin plated  
 Approvals:



**Ordering data**

Cross section mm <sup>2</sup>	flat hole M	dimensions in mm						weight 100 pcs./kg	Qty. (pcs.)	Order No.	Tool recommendation		
		d1	d3	d2	b	l	a				PZ PK 6/70 + PZ RK 6/70	EPG 45	APG 80 + HPG 80, EPG 45 APG 55 + HPG 55
35	6	8.5	12	6.4	15	33	17	1.93	25	1494790000	PZ PK 10/120 + PZ RK 10/120	EPG 45	APG 80 + HPG 80, EPG 45 APG 55 + HPG 55
	8			8.4	15	35		1.90	25	1494810000*			
50	6	10	14	6.4	15	37	19	2.69	25	1494820000			
	8			8.4	17	39		2.79	25	1494830000			
	10			10.5	17	41		2.99	25	1494840000			
70	6	11.8	16.5	6.4	17	41	21	3.99	25	1494850000			
	8			8.4	17	43		4.38	25	1494860000			
	10			10.5	17	45		4.40	25	1494870000			
	12			13	19	46		4.48	25	1494880000			
95	6	13.5	18	6.4	19	43	23	4.67	25	1494430000			
	8			8.4	19	45		4.90	25	1494890000			
	10			10.5	19	47		5.10	25	1494900000			
	12			13	19	48		5.20	25	1494910000			
120	6	14.7	20	6.4	20	49	26	6.43	10	1494410000			
	8			8.4	20	51		7.12	10	1494420000			
	10			10.5	20	53		6.70	10	1494920000			
	12			13	20	54		7.12	10	1494930000			
150	6	16.3	21.3	6.4	19	53	29	7.01	10	1494440000			
	8			8.4	19	55		7.31	10	1494940000			
	10			10.5	19	56		7.63	10	1494950000			
	12			13	22	59		7.63	10	1494970000			
185	10	18.7	24	10.5	26	60	30	10.47	10	1494980000			
	12			13	26	59.5		10.27	10	1494990000			
	16			17	26	64		10.81	10	1495000000			
240	10	21	26	10.5	30	65	35	12.80	5	1494340000			
	12			13	30	65		11.71	5	1494350000			
	16			17	30	68		12.11	5	1494370000			
300	10	23.5	30	10.5	30	76	42	19.66	5	1494380000*			
	12			13	30	79		20.08	5	1494390000*			
	16			17	30	81		20.60	5	1494400000*			

\* UL not tested

Tubular cable lugs with angle, copper, euro-series

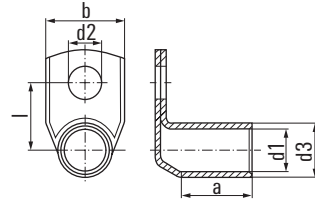

Tubular cable lugs with 90° angle,  
0.5 – 35 mm<sup>2</sup>, euro-series

Technical data

Material: Cu according to DIN EN 13600  
Surface: tin plated

Approvals:



Ordering data

Cross-section mm <sup>2</sup>	flat hole M	dimensions in mm						weight 100 pcs./kg	Qty. (pcs.)	Order No.	Tool recommendation
		d1	d3	d2	b	l	a				
0.5 - 0.75	3	1.4	3	3.2	6.5	7.5	5	0.09	100	1495180000*	HTN 21
	4			4.3	8.5	8.5		0.10	100	1495190000*	
	5			5.3	10	9.5		0.10	100	1495200000*	
1.0 - 1.5	3	1.9	3.9	3.2	6.5	8	5	0.16	100	1495210000*	PZ RK 6/7/0
	4			4.3	8.5	9		0.16	100	1495220000*	
	5			5.3	10	10		0.16	100	1495230000*	
	6			6.4	11	12		0.15	100	1495240000*	
2.5	4	2.4	4.4	4.3	8.5	9.2	5.5	0.18	100	1495250000*	PZ RK 10/120
	5			5.3	10	10.2		0.18	100	1495270000*	
	6			6.4	11	12.2		0.22	100	1495280000*	
	8			8.4	14	14.2		0.23	100	1495290000*	
4	4	3	5	4.3	8.5	9.5	7	0.25	100	1495300000*	EPG 45
	5			5.3	10	10.5		0.24	100	1495310000*	
	6			6.4	11	12.5		0.29	100	1495320000*	
	8			8.4	14	14.5		0.30	100	1495330000*	
6	4	3.5	6.5	4.3	10	10.3	8	0.52	100	1497220000	PZ RK 10/120
	5			5.3	11	11.2		0.56	100	1496120000	
	6			6.4	11	13.3		0.62	100	1496130000	
	8			8.4	15	15.3		0.64	100	1496140000	
	10			10.5	18	17.2		0.68	100	1496150000	
10	4			13	20	18.2		0.66	100	1496170000	PZ RK 10/120
	5	4.5	7	5.3	12	11.5	9	0.54	100	1497020000	
	6			6.4	12	12.5		0.59	100	1497030000	
	8			8.4	15	15.5		0.67	100	1497040000	
	10			10.5	18	17.5		0.70	100	1497050000	
16	12			13	20	18.5		0.70	100	1497070000	PZ RK 10/120
	5	5.5	8.5	5.3	12	13	12	1.07	100	1497080000	
	6			6.4	12	14.3		1.15	100	1497090000	
	8			8.4	15	16.3		1.20	100	1497100000	
	10			10.5	18	18.3		1.23	100	1497110000	
25	12			13	20	19.3		1.23	100	1497120000	PZ RK 10/120
	6	7	10	6.4	15	15.5	14	1.35	100	1495850000	
	8			8.4	16	17.5		1.43	100	1495870000	
	10			10.5	18	19.5		1.57	100	1495880000	
	12			13	20	20.5		1.51	100	1495890000	
35	14			15	22	22.5		1.69	100	1495900000	PZ RK 10/120
	6	8.5	12	6.4	17	16.5	16	2.10	100	1495910000	
	8			8.4	17	18.5		2.31	100	1495920000	
	10			10.5	20	20.5		2.36	100	1495930000	
	12			13	22	21.5		2.37	100	1495940000	
35	14			15	23	23.5		2.48	100	1494640000	PZ RK 10/120
	16			17	28	24.5		2.48	100	1494690000	

\* UL not tested

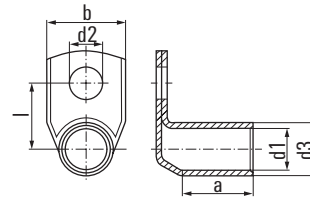

**Tubular cable lugs with 90° angle,  
50 – 300 mm<sup>2</sup>, euro-series**

**Technical data**

Material: Cu according to DIN EN 13600  
Surface: tin plated  
Approvals:



**Ordering data**

Cross-section mm <sup>2</sup>	flat hole M	dimensions in mm						weight 100 pcs./kg	Qty. (pcs.)	Order No.	Tool recommendation	
		d1	d3	d2	b	l	a					
50	6	10	14	6.4	20	17.5	18	3.00	100	1495950000	PZ PK 6/70 + PZ RK 6/70	EPG 45 APG 55 + HPG 55
	8			8.4	20	19.5		3.22	100	1495970000		
	10			10.5	20	21.5		3.32	100	1495980000		
	12			13	23	22.5		3.28	100	1495990000		
	14			15	23	24.5		3.37	100	1494650000		
	16			17	27	28.5		3.63	100	1496000000		
70	6	12	16.5	6.4	24	18.8	20	4.41	25	1496010000	PZ PK 10/120 + PZ RK 10/120	EPG 45 APG 80 + HPG 80, EPG 45
	8			8.4	24	20.8		4.86	25	1496020000		
	10			10.5	24	22.8		5.06	25	1496030000		
	12			13	24	23.8		4.94	25	1496040000		
	14			15	25	25.8		5.19	25	1494660000		
	16			17	28	26.8		5.11	25	1496050000		
95	8	13.5	18	8.4	26	21.5	22	5.33	25	1496080000		
	10			10.5	26	23.5		5.59	25	1496090000		
	12			13	26	24.5		5.66	25	1496100000		
	14			15	26	26.5		5.89	25	1494670000		
120	8	15	20	8.4	29	22.5	25	7.63	25	1494680000		
	10			10.5	29	24.5		8.07	25	1494450000		
	12			13	29	25.5		7.99	25	1494470000		
	16			17	30	28.5		8.46	25	1494480000		
150	8	16.8	21.3	8.4	31	25.7	28	8.03	25	1494490000		
	10			10.5	31	25.7		8.07	25	1494500000		
	12			13	31	26.7		8.29	25	1494510000		
	16			17	31	29.7		8.50	25	1494520000		
	20			21	35	33.7		8.89	25	1494530000		
185	10	19	24	10.5	35	27	29	11.41	25	1494540000		
	12			13	35	28		12.04	25	1494550000		
	16			17	35	31		12.48	25	1494570000		
	20			21	35	35		12.70	25	1494580000		
240	10	21	26	10.5	38	28	34	13.32	25	1494590000		
	12			13	38	29		13.40	25	1494610000		
	16			17	38	32		13.76	25	1494620000		
	20			21	38	36		14.23	25	1494630000		
300	12	24	30	13	43	31	41	19.92	20	1497300000		
	16			17	43	34		20.90	20	1497310000		
	20			21	43	38		21.81	20	1497320000		

\* UL not tested

## Tubular cable lugs with angle, copper, euro-series

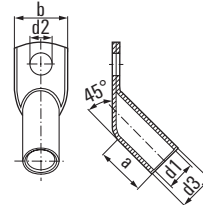
Tubular cable lugs with 45° angle,  
10 – 240 mm<sup>2</sup>, euro-series

## Technical data

Material:

Cu according to DIN EN 13600

Surface:

tin plated

Approvals:



## Ordering data

Cross-section mm <sup>2</sup>	flat hole M	dimensions in mm					weight 100 pcs./kg	Qty. (pcs.)	Order No.	Tool recommendation
		d1	d3	d2	b	a				
10	5	4.5	7	5.3	12	9	0.55	100	1496810000	PZ PK 6/70 + PZ RK 6/70 EPG 45 MTR 160 + MTR 300, APG 55 + HPG 55, APG 80 + HPG 80
	6			6.4	12		0.58	100	1496820000	
	8			8.4	15		0.65	100	1496830000	
	10			10.5	18		0.66	100	1496840000*	
16	5	5.5	8.5	5.3	12	12	0.95	100	1496850000	
	6			6.4	12		1.02	100	1496870000	
	8			8.4	15		1.17	100	1496880000	
	10			10.5	18		1.17	100	1496890000	
25	6	7	10	6.4	15	14	1.39	100	1496180000	
	8			8.4	16		1.51	100	1496190000	
	10			10.5	18		1.66	100	1496200000	
	12			13	20		1.70	100	1496210000	
35	6	8.5	12	6.4	17	16	2.17	50	1496220000	
	8			8.4	17		2.23	50	1496230000	
	10			10.5	20		2.34	50	1496240000	
	12			13	22		2.40	50	1496250000	
50	6	10	14	6.4	20	18	2.94	50	1496270000*	
	8			8.4	20		3.34	50	1496280000	
	10			10.5	20		3.65	50	1496290000	
	12			13	23		3.65	50	1496300000	
70	8	12	16.5	8.4	24	20	4.90	25	1496310000	
	10			10.5	24		5.23	25	1496320000	
	12			13	24		5.34	25	1496330000	
95	8	13.5	18	8.4	26	22	6.18	25	1496340000	
	10			10.5	26		6.20	25	1496350000	
	12			13	26		6.20	25	1496370000	
	16			17	28		6.80	25	1496380000*	
120	8	15	20	8.4	29	25	7.80	25	1496390000	
	10			10.5	29		8.90	25	1496400000	
	12			13	29		8.91	25	1496410000	
	16			17	30		9.31	25	1496420000	
150	8	16.8	21.3	8.4	31	28	11.31	25	1496430000*	
	10			10.5	31		9.80	25	1496440000	
	12			13	31		9.68	25	1496450000	
	16			17	31		10.12	25	1496470000	
	20			21	35		10.12	25	1496480000*	
185	10	19	24	10.5	35	29	12.35	20	1495340000	
	12			13	35		12.24	20	1495350000	
	16			17	35		12.84	20	1495370000	
	20			21	35		13.99	20	1495380000	
240	12	21	26	13	38	34	15.46	15	1495400000	
	16			17	38		16.51	15	1495410000	
	20			21	38		17.04	15	1495420000	

\* UL not tested

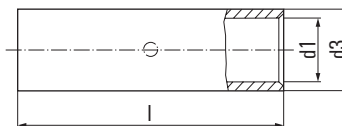

**Joint connector 0.5 – 240 mm<sup>2</sup>  
euro-series**

**Technical data**

Material: Cu according to DIN EN 13600  
 Surface: tin plated  
 Type: with wirestop

**Ordering data**

Cross-section mm <sup>2</sup>	dimensions in mm			weight 100 pcs./kg	Qty. (pcs.)	Order No.	Tool recommendation			
	d1	d3	l				HTN 21	EPG 45	MTR 110	APG 55 + HPG 55, APG 80 + HPG 80
0.5 - 0.75	1.4	3	15	0.08	100	1497330000				
1.0 - 1.5	1.9	3.9	15	0.12	100	1497340000				
2.5	2.4	4.4	16	0.15	100	1497350000				
4	3	5	19	0.21	100	1497370000				
6	3.5	6.5	25	0.51	100	1494720000				
10	4.5	7	30	0.60	50	1497130000				
16	5.5	8.5	35	1.00	50	1497140000				
25	7	10	40	1.41	50	1494730000				
35	8.5	12	45	2.16	50	1494740000				
50	10	14	50	3.32	50	1494750000				
70	12	16.5	55	4.91	50	1494760000				
95	13.5	18	60	6.09	50	1494770000				
120	15	20	65	7.88	25	1494780000				
150	16.8	21.3	70	8.68	25	1497380000				
185	19	24	75	11.63	25	1497390000				
240	21	26	85	14.22	25	1497400000				





# Crimp cable lugs, copper DIN 46235



K

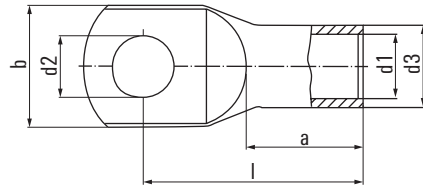

### Crimp cable lugs, copper 6 – 95 mm<sup>2</sup>, DIN 46235

#### Technical data

Material: Cu according to DIN EN 13600  
Surface: tin plated

#### Ordering data

Cross-section mm <sup>2</sup>	flat hole M	die code	d1	d3	dimensions in mm					weight 100 pcs./kg	Qty. (pcs.)	Order No.	Tool recommendation
					d2	b	l	a					
6	5	5	3.7	5.5	5.3	8.5	24	10	0.31	100	1497840000	PZ PK 6/70 CTN 25 D5 EPG 45, APG 55 + HPG 55, APG 80 + HPG 80 PZ PK 10/120	
	6			6.4	9	24			0.34	100	1497850000		
	8*			8.4	13	26			0.35	100	1497860000		
10	5	6	4.4	6	5.3	10	27	10	0.35	100	1497870000		
	6			6.4	10	27			0.37	100	1497880000		
	8*			8.4	13	28			0.38	100	1497890000		
	10*			10.5	15	29			0.38	100	1497910000		
16	5*	8	5.5	8.5	5.3	13	36	20	1.22	100	1497920000		
	6			6.4	13	36			1.27	100	1497930000		
	8			8.4	13	37			1.30	100	1497940000		
	10			10.5	16.5	38			1.32	100	1497950000		
	12*			13	19	40			1.35	100	1497960000		
25	6	10	7	10	6.4	14	39	20	1.62	100	1497970000		
	8			8.4	17	39			1.73	100	1497980000		
	10			10.5	17	40.5			1.77	100	1497990000		
	12			13	18	40.5			1.72	100	1498000000		
	16*			17	22	45			1.99	100	1498010000		
35	6*	12	8.2	12.5	6.4	17.5	42.5	20	3.12	100	1498020000		
	8			8.4	18	42			3.19	100	1498030000		
	10			10.5	20	42.5			3.17	100	1498040000		
	12			13	21	44			3.11	100	1498050000		
	16*			17	28	47			3.14	100	1498060000		
50	6*	14	9.8	14.5	6.4	20	52	28	4.67	100	1498510000		
	8			8.4	20	52			5.00	100	1498070000		
	10			10.5	22	52			4.94	100	1498080000		
	12			13	23	52			4.91	100	1498090000		
	14*			15	26	53.5			4.94	100	1498570000		
	16			17	28	55.5			5.04	100	1498110000		
70	20*			21	30	61.5			5.56	100	1498120000		
	8	16	11.3	16.5	8.4	24	56	28	6.54	50	1498130000		
	10			10.5	24	56			6.54	50	1498140000		
	12			13	24	56.5			6.57	50	1498150000		
	14*			15	24	55.5			6.00	50	1498560000		
	16			17	29	57			6.92	50	1498160000		
95	20*			21	31	61			6.99	50	1498170000		
	8*	18	13.5	19	8.4	28	65	35	9.36	50	1498180000		
	10			10.5	28	65.5			9.55	50	1498190000		
	12			13	28	65.5			9.45	50	1498210000		
	14*			15	28	65.5			9.43	50	1498520000		
20*	16			17	30	65.5			9.44	50	1498220000		
	20*			21	33	71			9.86	50	1498230000		

\* not standardized, tube measurements in accordance with DIN 46235

Crimp cable lugs, copper, DIN 46235

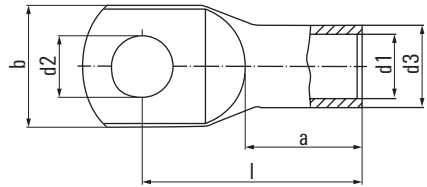

Crimp cable lugs, copper, 120 - 300 mm<sup>2</sup>, DIN 46235

Technical data

Material: Cu according to DIN EN 13600  
 Surface: tin plated

Ordering data

Cross-section mm <sup>2</sup>	flat hole M	die code	dimensions in mm						weight 100 pcs./kg	Qty. (pcs.)	Order No.	Tool recommendation		
			d1	d3	d2	b	l	a				PZPK 10/120	EPG 45	APG 80 + HPG 80 APG 55 + HPG 55
120	8*	20	15.5	21	8.4	31	70	35	11.35	50	1498480000	PZPK 10/120	EPG 45	APG 80 + HPG 80 APG 55 + HPG 55
	10				10.5	31	70		11.40	50	1498240000			
	12				13	31	70.5		11.43	50	1498250000			
	14*				15	31	70		11.41	50	1498490000			
	16				17	31.5	70		11.36	50	1498270000			
	20				21	36	72		11.51	50	1498280000			
150	8*	22	17	23.5	8.4	34	79	35	16.40	25	1498290000			
	10				10.5	34	79		16.46	25	1498310000			
	12				13	34	78.5		16.53	25	1498320000			
	14*				15	34	78		16.49	25	1498580000			
	16				17	34	78		16.35	25	1498330000			
	20				21	38	78		16.34	25	1498340000			
185	8*	25	19	25.5	8.4	37	83	40	18.50	25	1498540000			
	10				10.5	37	83		18.50	25	1498350000			
	12				13	37	82.5		18.95	25	1498360000			
	14*				15	37	82		18.96	25	1498590000			
	16				17	37	82		19.41	25	1498370000			
	20				21	40	83		19.01	25	1498380000			
240	10*	28	21.5	29	10.5	42	92	40	27.10	20	1498390000			
	12				13	42.5	92		26.65	20	1498410000			
	14*				15	42.5	92		26.73	20	1498530000			
	16				17	42.5	92		27.45	20	1498420000			
	20				21	45	92		27.67	20	1498430000			
300	10*	32	24.5	32	10.5	48.5	104	50	34.80	10	1498440000			
	12*				13	48.5	104		34.50	10	1498450000			
	14*				15	48.5	104		34.60	10	1498550000			
	16				17	48.5	100		34.16	10	1498460000			
	20				21	48.5	100		34.46	10	1498470000			

\* not standardized, tube measurements in accordance with DIN 46235

**Tubular compression connectors  
6 - 300 mm<sup>2</sup>, DIN 46267 part 1,  
strain relieved**

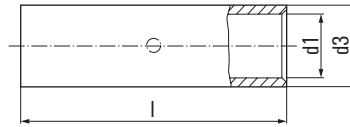

**Technical data**

Material: Cu according to DIN EN 13600  
Surface: tin plated

**Ordering data**

Cross-section mm <sup>2</sup>	die code	dimensions in mm			weight 100 pcs./kg	Qty. (pcs.)	Order No.	Tool recommendation					
		d1	d3	l				PZ PK 6/70	CTN 25 D5	PZ PK 10/120	EPG 45	APG 80 + HPG 80 APG 55 + HPG 55	
6	5	3.7	5.5	30	0.35	100	1498610000						
10	6	4.4	6	30	0.35	100	1498620000						
16	8	5.5	8.5	50	1.51	100	1498630000						
25	10	7	10	50	1.86	100	1498640000						
35	12	8.2	12.5	50	3.20	100	1498650000						
50	14	9.8	14.5	56	4.64	50	1498660000						
70	16	11.3	16.5	56	5.64	50	1498670000						
95	18	13.5	19	70	8.98	50	1498680000						
120	20	15.5	21	70	10.27	25	1498690000						
150	22	17	23.5	80	14.96	25	1498710000						
185	25	19	25.5	85	16.78	25	1498720000						
240	28	21.5	29	90	23.20	15	1498730000						
300	32	24.5	32	100	30.52	10	1498740000						



# Terminals noninsulated



K

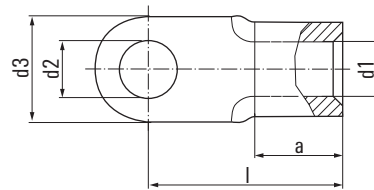

## Terminals 0.1 – 6 mm<sup>2</sup>, DIN 46234

### Technical data

Material:	Cu-HCP
Surface:	tin plated S = small palm

### Ordering data

Cross-section mm <sup>2</sup>	flat hole M	d1	dimensions in mm				weight 100 pcs./kg	Qty. (pcs.)	Order No.	Tool recommendation
			d2	d3	l	a				
0.1 - 0.5	2	1	2.2	5	10	4	0.02	100	1493670000	HTN 21
	3		3.2	5	10		0.02	100	1493680000	
	4		4.3	6.5	12		0.03	100	1493690000	
	5		5.3	8	11		0.03	100	1493700000	
0.5 - 1	2*	1.6	2.2	6	11	5	0.06	100	1493720000	
	2.5		2.7	6	11		0.06	100	1493730000	
	3		3.2	6	11		0.06	100	1493740000	
	3.5		3.7	6	11		0.06	100	1493750000	
	4/S*		4.3	7	11		0.06	100	1493760000	
	4		4.3	8	12		0.07	100	1493770000	
	5/S*		5.3	8	12		0.06	100	1493780000	
	5		5.3	10	13		0.08	100	1493790000	
	6*		6.5	10	13		0.07	100	1493800000	
	8*		8.4	12	17		0.10	100	1493810000	
10*		10.5	14	17		0.10	100	1493710000		
1.5 - 2.5	3	2.3	3.2	6	11	5	0.07	100	1493820000	
	3.5		3.7	6	11		0.06	100	1493830000	
	4/S*		4.3	6.8	11		0.06	100	1493840000	
	4		4.3	8	12		0.08	100	1493850000	
	5/S*		5.3	8	12		0.07	100	1493870000	
	5		5.3	10	14		0.10	100	1493890000	
	6		6.5	11	16		0.11	100	1493900000	
	8		8.4	14	17		0.14	100	1493910000	
10*		10.5	18	20		0.19	100	1493930000		
12*		13	18	20		0.16	100	1493940000		
4 - 6	4	3.6	4.3	8	14	6	0.14	100	1493950000	EPG 45
	5		5.3	10	15		0.16	100	1493960000	
	6		6.5	11	16		0.17	100	1493970000	
	8		8.4	14	19		0.21	100	1493980000	
	10		10.5	18	21		0.27	100	1493990000	
12*		13	18	21		0.23	100	1494000000	APG 80 + HPG 80 APG 55 + HPG 55	

\* not standardized, dimensions similar to DIN 46234

## Terminals ring and fork-type, noninsulated

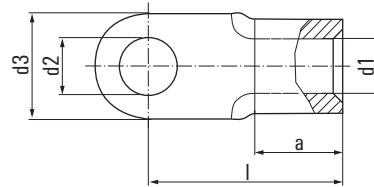
Terminals 10 – 240 mm<sup>2</sup>,  
DIN 46234

## Technical data

Material: Cu-HCP  
Surface: tin plated

## Ordering data

Cross-section mm <sup>2</sup>	flat hole M	dimensions in mm					weight 100 pcs./kg	Qty. (pcs.)	Order No.	Tool recommendation
		d1	d2	d3	l	a				
10	4*	4.5	4.3	10	16	8	0.23	100	1494010000	CTN 25 DA EPG 45 APG 80 + HPG 80 APG 55 + HPG 55
	5	5.3	10	16			0.22	100	1494020000	
	6	6.5	11	17			0.24	100	1494030000	
	8	8.4	14	20			0.29	100	1494040000	
	10	10.5	18	21			0.35	100	1494050000	
	12	13	22	23			0.41	100	1494060000	
16	5	5.8	5.3	11	20	10	0.40	100	1494070000	
	6	6.5	11	20			0.38	100	1494080000	
	8	8.4	14	22			0.42	100	1494090000	
	10	10.5	18	24			0.50	100	1494100000	
	12	13	22	26			0.58	100	1494110000	
	25	5	7.5	5.3	12	25	11	0.70	50	
6		6.5	12	25			0.71	50	1494130000	
8		8.4	16	25			0.76	50	1494140000	
10		10.5	18	26			0.78	50	1494150000	
12		13	22	31			0.97	50	1494160000	
16		17	28	35			1.20	50	1493490000	
35	6	9	6.5	15	26	12	0.97	50	1494170000	
	8	8.4	16	26			0.96	50	1494180000	
	10	10.5	18	27			1.00	50	1494190000	
	12	13	22	31			1.17	50	1493130000	
	16	17	28	36			1.41	50	1493140000	
	20*	21	30	37.5	14		1.67	50	1493520000	
50	6	11	6.5	18	34	16	1.75	50	1493510000	
	8	8.4	18	34			1.72	50	1493150000	
	10	10.5	18	34			1.66	50	1493160000	
	12	13	22	36			1.80	50	1493170000	
	16	17	28	40			2.11	50	1493180000	
	20*	21	32	41.2	18		2.57	50	1493530000	
70	6	13	6.5	22	38	18	2.66	50	1493190000	
	8	8.4	22	38			2.34	50	1493210000	
	10	10.5	22	38			2.58	50	1493220000	
	12	13	22	38			2.49	50	1493230000	
	16	17	28	42			2.77	50	1493240000	
	20*	21	32	45	19		3.06	50	1493250000	
95	8	15	8.4	24	42	20	4.24	25	1493260000	
	10	10.5	24	42			4.17	25	1493270000	
	12	13	24	42			3.92	25	1493280000	
	16	17	28	44			3.94	25	1493290000	
	20*	21	32	51.8			4.25	25	1493310000	
	120	8	16.5	8.4	24	44	22	5.77	25	1493320000
10		10.5	24	44			5.67	25	1493330000	
12		13	24	44			5.42	25	1493340000	
16		17	28	48			6.21	25	1493350000	
20*		21	32	53	21		5.81	25	1493360000	
150		10	19	10.5	30	50	24	8.29	25	1493370000
	12	13	30	50			8.31	25	1493380000	
	16	17	30	50			8.01	25	1493390000	
	20*	21	36	63	27		7.35	25	1493410000	
	185	10	21	10.5	36	50	28	11.16	25	1493420000
12		13	36	50			10.78	25	1493430000	
16		17	36	50			10.61	25	1493440000	
20*		21	36	50			10.17	25	1493450000	
240		10	23.5	10.5	38	56	32	15.01	25	1493460000
	12	13	38	56			14.98	25	1493470000	
	16	17	38	56			14.53	25	1493480000	

\* not standardized

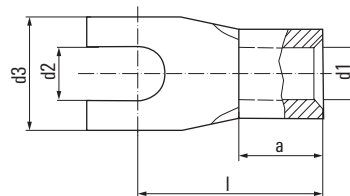

**Terminals**  
fork-type 0,5 – 16 mm<sup>2</sup>

**Technical data**

Material: Cu-HCP (0,5 - 10 mm<sup>2</sup>)  
Cu-ETP (16 mm<sup>2</sup>)  
Surface: tin plated  
S = small palm

**Ordering data**

Cross-section mm <sup>2</sup>	flat hole M	dimensions in mm					weight 100 pcs./kg	Qty. (pcs.)	Order No.	Tool recommendation		
		d1	d2	d3	l	a						
0.5 - 1	C 3	1.6	3.2	6	11	5	0.06	100	1493540000	HTN 21	EPG 45	APG 80 + HPG 80 APG 55 + HPG 44
	C 3.5		3.7	6	11		0.05	100	1493550000			
	C 4/S		4.3	7	12		0.06	100	1493560000			
	C 4		4.3	8	12		0.07	100	1493570000			
	C 5		5.3	10	13		0.08	100	1493580000			
	C 6		6.5	12	17		0.09	100	1493590000			
1.5 - 2.5	C 3	2.3	3.2	6	11	5	0.06	100	1493600000			
	C 3.5		3.7	6.8	11		0.07	100	1493610000			
	C 4/S		4.3	6.8	11		0.06	100	1493620000			
	C 4		4.3	8	12		0.08	100	1493630000			
	C 5		5.3	10	14		0.10	100	1493640000			
	C 6		6.5	11	16		0.11	100	1493650000			
4 - 6	C 4	3.6	4.3	8	14	6	0.14	100	1493660000			
	C 5		5.3	10	15		0.16	100	1492650000			
	C 6		6.5	11	16		0.16	100	1492660000			
	C 8		8.4	14	19		0.19	100	1492670000			
10	C 5	4.5	5.3	10	16	8	0.23	100	1492680000	CTN 25 D4		
	C 6		6.5	11	17		0.24	100	1492690000			
16	C 6	5.8	6.5	11	20	10	0.48	50	1492700000			
	C 8		8.4	14	22		0.50	50	1492710000			



Pin cable lugs DIN 46230, noninsulated

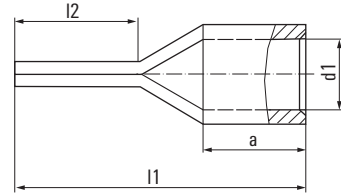

Pin cable lugs 0.1 – 95 mm<sup>2</sup>,  
DIN 46230

Technical data

Material: Cu-HCP (0.1 – 6 mm<sup>2</sup>)  
Cu-ETP (10 – 95 mm<sup>2</sup>)  
Surface: tin plated

Ordering data

Cross-section mm <sup>2</sup>	dimensions in mm				Ø pin	weight 100 pcs./kg	Qty. (pcs.)	Order No.	Tool recommendation		
	d1	l1	l2	a							
0.1 – 0.5	1	14	9	4	1.2	0.02	100	1492720000	HTN 21		
0.5 – 1	1.6	17	10	5	1.9	0.06	100	1492730000			
1.5 – 2.5	2.3	17	10	5	1.9	0.07	100	1492740000			
		22	15			0.09	100	1492750000*	CTN 25 D4		
4 – 6	3.6	20	11	6	2.6	0.15	100	1492770000			
10	4.5	22	12	8	2.3 x 4.2	0.25	100	1492780000			
16	5.8	26	13	10	2.5 x 5.6	0.41	100	1492790000			
25	7	34.1	16	14	2.5 x 6.9	0.66	50	1492800000*			
35	8.4	41	20	16	3.2 x 8.1	1.19	50	1492810000*			
50	9.5	45.7	21	19	3.7 x 9.5	1.88	50	1492820000*			
70	11.2	55	24	24	4 x 11	3.01	50	1492830000*			
95	13.5	55.5	22	24	5.1 x 12.3	4.2	25	1492840000*			

\* not standardized

**Parallel connectors 0.1 – 150 mm<sup>2</sup>, form A, DIN 46341 part 1**

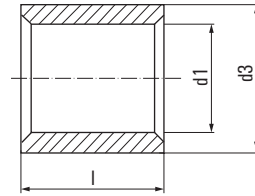

**Technical data**

Material: Cu-HCP  
Surface: tin plated

**Ordering data**

Cross-section mm <sup>2</sup>	dimensions in mm			weight 100 pcs./kg	Qty. (pcs.)	Order No.	Tool recommendation		
	l	d1	d3				HTN 21	EPG 45	APG 80 + HPG 80
0.1 – 0.5*	5	1.2	2	0.01	100	1492850000	CTN 25 DA	APG 55 + HPG 44	APG 80 + HPG 80
0.5 – 1	7	1.6	3.3	0.04	100	1492860000			
1.5 – 2.5	7	2.3	4	0.05	100	1492870000			
4 – 6	7	3.6	5.7	0.09	100	1492880000			
10	9	4.6	6.8	0.15	100	1492890000			
16	10	5.9	8.3	0.23	100	1492900000			
25	12.5	7.7	10.7	0.45	100	1492910000			
35	14	9.2	12.4	0.65	100	1492920000			
50	17.5	11.2	14.8	1.13	100	1492930000			
70	18	13.5	17.5	1.59	100	1492940000			
95	19	15	20	2.34	50	1492950000			
120	21	16.7	22.7	3.53	50	1492960000			
150	25	19	25.5	5.02	50	1492970000			

\* not standardized

**Joint connector 0.1 – 150 mm<sup>2</sup>, form B, DIN 46341 part 1**

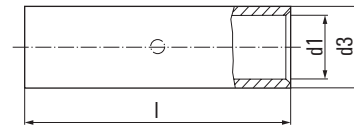

**Technical data**

Material: Cu-HCP  
Surface: tin plated

**Ordering data**

Cross-section mm <sup>2</sup>	dimensions in mm			weight 100 pcs./kg	Qty. (pcs.)	Order No.	Tool recommendation		
	l	d1	d3				HTN 21	EPG 45	APG 80 + HPG 80
0.1 – 0.5*	12	1.2	2	0.02	100	1492980000	CTN 25 DA	APG 55 + HPG 55	APG 80 + HPG 80
0.5 – 1	15	1.6	3.3	0.09	100	1492990000			
1.5 – 2.5	15	2.3	4	0.11	100	1493010000			
4 – 6	15	3.6	5.7	0.18	100	1493020000			
10	20	4.6	6.8	0.36	100	1493030000			
16	26	5.9	8.3	0.61	100	1493040000			
25	29	7.7	10.7	1.13	100	1493050000			
35	32	9.2	12.4	1.55	100	1493060000			
50	38	11.2	14.8	2.44	100	1493070000			
70	42	13.5	17.5	3.73	50	1493080000			
95	48	15	20	6.08	50	1493090000			
120	52	16.7	22.7	8.67	50	1493110000			
150	56	19	25.5	11.25	50	1493120000			

\* not standardized

# Insulated connectors

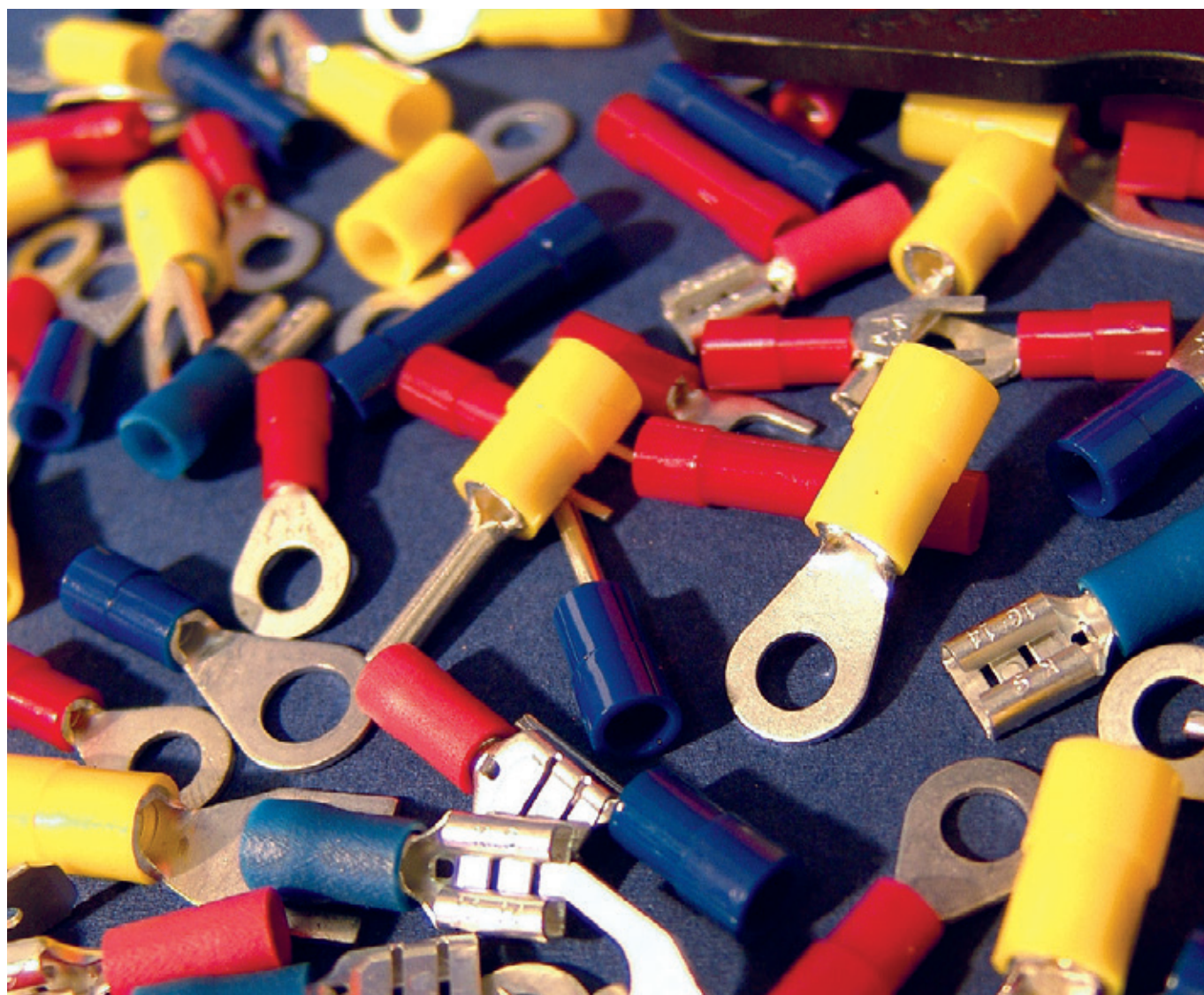

K

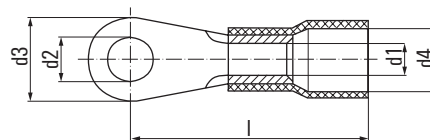

**Terminals 0.1 – 6 mm<sup>2</sup>  
DIN 46237 soldered seam and  
easy-entry insulation**

**Technical data**

Material: Cu-ETP  
insulation: PC  
or  
\* insulation: PA  
Surface: tin plated  
S = small palm

**Ordering data**

Cross-section mm <sup>2</sup>	flat hole M	colour of insulation	d1	dimensions in mm				Cu- weight 100 pcs./kg	Qty. (pcs.)	Order No.	Tool recommendation
				d4	d2	d3	l				
0.1 – 0.5	2	yellow	1	2.3	2.2	5	14	0.02	100	1492090000*	
	3				3.2	5	14	0.02	100	1492100000*	
	4				4.3	6.5	16	0.03	100	1492110000*	
	5				5.3	8	16	0.03	100	1492120000*	
0.5 – 1	2	red	1.6	4	2.2	6	17	0.06	100	1492140000	
	2.5				2.7	6	17	0.06	100	1492150000	
	3				3.2	6	17	0.06	100	1492170000	
	3.5				3.7	6	17	0.06	100	1492180000	
	4/S				4.3	7	17.5	0.06	100	1492190000	
	4				4.3	8	18	0.07	100	1492200000	
	5/S				5.3	8	18.5	0.06	100	1492210000	
	5				5.3	10	19	0.08	100	1492220000	
	6				6.5	10	19	0.07	100	1492230000	
	8				8.4	14	23	0.10	100	1492240000	
10				10.5	18	25	0.10	100	1492130000		
1.5 – 2.5	3	blue	2.3	4.4	3.2	6	17	0.07	100	1492250000	
	3.5				3.7	6	17	0.06	100	1492270000	
	4/S				4.3	6.8	17.6	0.06	100	1492280000	
	4				4.3	8	18	0.08	100	1492290000	
	5/S				5.3	8	19.5	0.07	100	1492300000	
	5				5.3	10	20	0.10	100	1492310000	
	6				6.5	11	22	0.11	100	1492320000	
	8				8.4	14	23	0.14	100	1492330000	
10				10.5	18	25.6	0.19	100	1492340000		
12				13	18	26	0.16	100	1492350000		
4 – 6	4	yellow	3.6	6.4	4.3	8	21	0.14	100	1492370000	
	5				5.3	10	22	0.16	100	1492380000	
	6				6.5	11	23	0.17	100	1492390000	
	8				8.4	14	26	0.21	100	1492400000	
	10				10.5	18	28	0.27	100	1492410000	
12				13	18	28	0.23	100	1492420000		

\* insulation PA

HTI 15

CTI 6 + CTI 66

**Terminals 10 – 16 mm<sup>2</sup>  
with soldered seam and easy-entry  
insulation**

**Technical data**

Material: Cu-ETP  
insulation: PA  
Surface: tin plated

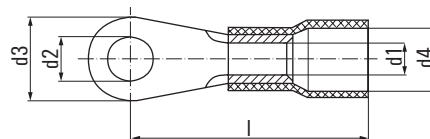

**Ordering data**

Cross-section mm <sup>2</sup>	flat hole M	colour of insulation	d1	dimensions in mm				Cu- weight 100 pcs./kg	Qty. (pcs.)	Order No.	Tool recommendation
				d4	d2	d3	l				
10	5	red	4,5	8	5,3	10	24,5	0,22	50	1492430000	
	6				6,5	11	25,5	0,24	50	1492440000	
	8				8,4	14	28,5	0,29	50	1492450000	
	10				10,5	18	29,5	0,35	50	1492470000	
16	5	blue	5,8	10,5	5,3	11	31,5	0,40	50	1492480000	
	6				6,5	11	31,5	0,38	50	1492490000	
	8				8,4	14	33,5	0,42	50	1492500000	
	10				10,5	18	35,5	0,50	50	1492510000	

EPG 45

APG 80 + HPG 80

APG 55 + HPG 55

Terminals fork type

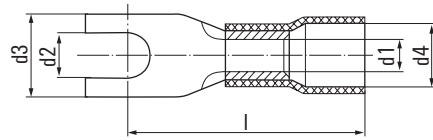

Terminals fork type 0.5 – 16 mm<sup>2</sup> with soldered seam and easy-entry insulation

Technical data

Material: Cu-ETP  
insulation: PC or  
\* insulation: PA  
Surface: tin plated  
S = small palm

Ordering data

Cross-section mm <sup>2</sup>	flat hole M	colour of insulation	dimensions in mm					Cu-weight 100 pcs./kg	Qty. (pcs.)	Order No.	Tool recommendation	
			d1	d4	d2	d3	l					
0.5 - 1	C 3	red	1.6	4	3.2	6	17	0.06	100	1492520000	HTI 15	CTI 6 + CTI 6G
	C 3.5				3.7	6	17	0.05	100	1492530000		
	C 4/S				4.3	6.8	18	0.06	100	1492540000		
	C 4				4.3	8	18.1	0.07	100	1492550000		
	C 5				5.3	10	19	0.08	100	1492580000		
	C 6				6.5	11	21	0.09	100	1492590000		
1.5 - 2.5	C 3	blue	2.3	4.5	3.2	5.5	19	0.06	100	1492600000		
	C 3.5				3.7	6	17	0.07	100	1492610000		
	C 4/S				4.3	6.8	18.7	0.06	100	1492620000		
	C 4				4.3	8	18	0.08	100	1492630000		
	C 5				5.3	10	20	0.10	100	1492640000		
	C 6				6.5	11	22	0.11	100	1491260000		
4 - 6	C 4	yellow	3.6	6.4	4.3	8	21	0.14	100	1491270000		
	C 5				5.3	10	22	0.16	100	1491280000		
	C 6				6.5	11	23	0.16	100	1491290000		
	C 8				8.4	14	26	0.19	100	1491310000		
	C 10				10.5	18	28	0.33	100	1491320000		
10	C 5	red	4.5	8	5.3	10.5	24.1	0.23	50	1491330000*	EPG 45	APG 80 + HPG 80
	C 6				6.5	10.8	24.6	0.24	50	1491340000*		
16	C 6	blue	5.8	11	6.5	11	32.2	0.48	50	1491350000*		
	C 8				8.4	13.8	32.2	0.50	50	1491360000*		

\* insulation PA

### Pin cable lugs 0.1 – 35 mm<sup>2</sup> DIN 46231 with soldered seam and easy-entry insulation

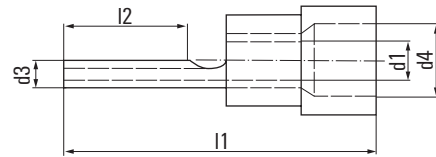

#### Technical data

Material:	Cu-HCP (0.1 – 0.5 mm <sup>2</sup> ) or Cu-ETP (0.5 – 35 mm <sup>2</sup> )
Isolation:	PC (resp. *PA)
Surface:	tin plated

#### Ordering data

Cross-section mm <sup>2</sup>	colour of insulation	d1	d4	d3	l1	l2	Cu-weight 100 pcs./kg	Qty. (pcs.)	Order No.
0.1 – 0.5	yellow	1	2.2	1.2	18	9	0.02	100	1491370000*
0.5 – 1	red	1.7	4	1.9	22.8	11	0.06	100	1491380000
1.5 – 2.5	blue	2.3	4.5	1.9	22.8	11	0.07	100	1491390000
	blau					27	14	0.09	100
4 – 6	yellow	3.6	6.4	2.8	27	11	0.15	100	1491420000
10	red	4.5	7.8	2.4 x 4.3	34	12	0.25	50	1491430000*
16	blue	5.8	9.1	2.5 x 5.6	40.7	13.5	0.41	50	1491440000*

\* insulation PA

### Joint connector 0.1 – 6 mm<sup>2</sup> with soldered seam and easy-entry insulation

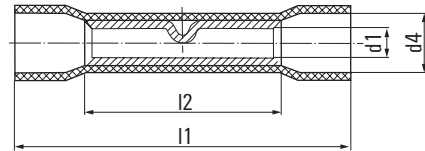

#### Technical data

Material:	Cu-HCP (0.1 – 0.5 mm <sup>2</sup> ) or Cu-ETP (0.5 – 6 mm <sup>2</sup> )
Isolation:	PC (resp. *PA)
Surface:	tin plated

#### Ordering data

Cross-section mm <sup>2</sup>	colour of insulation	d1	d4	l1	l2	Cu-weight 100 pcs./kg	Qty. (pcs.)	Order No.
0.1 – 0.5	yellow	1.2	2	12	20	0.02	100	1491540000*
0.5 – 1	red	1.6	4.1	15	25	0.09	100	1491550000
1.5 – 2.5	blue	2.3	4.5	15	26	0.11	100	1491560000
4 – 6	yellow	3.6	6.4	15	27	0.18	100	1491570000

\* insulation PA

### Joint connector 0.14 – 6 mm<sup>2</sup> with heat shrink insulation and lined tubing

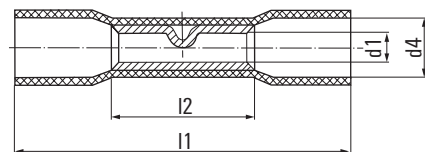

#### Technical data

Material:	Cu-ETP tin plated
Isolation:	0.14 – 0.5 mm <sup>2</sup> = Polyolefin 0.5 – 6 mm <sup>2</sup> = Polyethylen
Shrink temperature:	approx. 120 °C

#### Ordering data

Cross-section mm <sup>2</sup>	colour of insulation	d1	d4	l21	l2	Cu-weight 100 pcs./kg	Qty. (pcs.)	Order No.
0.14 – 0.5	yellow	1.4	3.1	11.5	24.5	0.04	50	1491490000
0.5 – 1	red	1.7	4.4	15	36	0.09	50	1491510000
1.5 – 2.5	blue	2.3	5.2	15	36	0.11	50	1491520000
4 – 6	yellow	3.6	6.5	15	41	0.18	20	1491530000

\* insulation PA

## Parallel connectors / closed end connectors

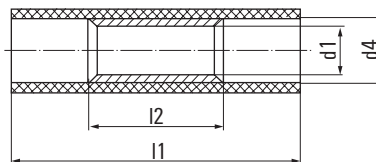
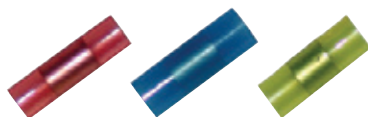
Parallel connectors 0.1 – 6 mm<sup>2</sup>

## Technical data

Material:	Cu-HCP
Insulation:	PA
Surface:	tin plated

## Ordering data

Cross-section mm <sup>2</sup>	colour of insulation	d1	d4	dimensions in mm		Cu-weight 100 pcs./kg	Qty. (pcs.)	Order No.
				l2	l1			
0,1 – 0,5	yellow	1,2	2	5	12	0,01	100	1491450000
0,5 – 1	red	1,7	3,2	7	17	0,04	100	1491460000
1,5 – 2,5	blue	2,3	4	7	17	0,05	100	1491470000
4 – 6	yellow	3,6	5,4	7	21,2	0,09	100	1491480000

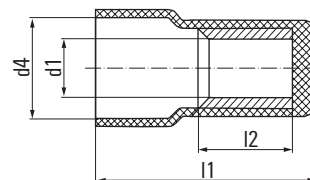
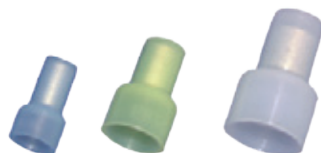
Closed end connectors 1.5 – 10 mm<sup>2</sup>  
one side closed

## Technical data

Material:	Cu-ETP
Insulation:	PA
Surface:	tin plated

## Ordering data

Cross-section mm <sup>2</sup>	colour of insulation	d1	d4	dimensions in mm		Cu-weight 100 pcs./kg	Qty. (pcs.)	Order No.
				l21	l2			
1.5 – 2.5	blue transparent	2.3	6.4	8	15.4	0.05	100	1491580000
4 – 6	yellow transparent	3.4	9.2	8.5	17.7	0.09	100	1491590000
10	transparent	5	11.8	8	22	0.15	50	1491610000

\* insulation PA



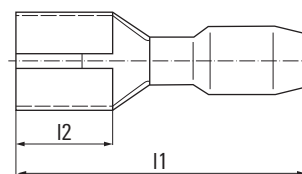

### Cable-lug sleeves 0.5 – 6 mm<sup>2</sup>

#### Technical data

Material:	MS
Insulation:	PVC
Surface:	tin plated

#### Ordering data

Cross-section mm <sup>2</sup>	colour of insulation	dimensions in mm				Cu-weight 100 pcs./kg	Qty. (pcs.)	Order No.
		tab- width	tab- thickness	l1	l2			
0.5 - 1	red	2.8	0.5	19	6.5	0.08	100	1491640000
		2.8	0.8	19	6.5	0.08	100	1491650000
		4.8	0.5	19.4	6.4	0.09	100	1491660000
		4.8	0.8	19.4	6.4	0.09	100	1491670000
1.5 - 2.5	blue	6.3	0.8	20.8	7.5	0.10	100	1491680000
		2.8	0.5	19	6.5	0.08	100	1491730000
		2.8	0.8	19	6.5	0.08	100	1491740000
		4.8	0.5	19.4	6.4	0.09	100	1491690000
		4.8	0.8	19.4	6.4	0.09	100	1491710000
4 - 6	yellow	6.3	0.8	23.3	7.3	0.18	100	1491750000
		9.5	1.2	28.6	12	0.27	100	1491760000

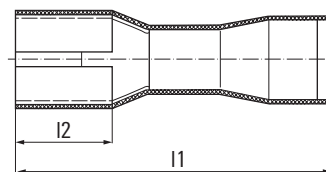

### Cable-lug sleeves 0.5 – 6 mm<sup>2</sup> completely insulated

#### Technical data

Material:	Ms
Insulation:	PVC
Surface:	tin plated

#### Ordering data

Cross-section mm <sup>2</sup>	colour of insulation	dimensions in mm				Cu-weight 100 pcs./kg	Qty. (pcs.)	Order No.
		tab- width	tab- thickness	l1	l2			
0.5 - 1	red	2.8	0.5	19.2	6.4	0.08	100	1491860000
		2.8	0.8	19.2	6.4	0.08	100	1491870000
		4.8	0.5	20.2	6.4	0.10	100	1491880000
		4.8	0.8	20.2	6.4	0.10	100	1491890000
		6.3	0.8	21.5	7.3	0.11	100	1491910000
1.5 - 2.5	blue	4.8	0.5	20.2	6.5	0.11	100	1491920000
		4.8	0.8	20.2	6.5	0.11	100	1491930000
		6.3	0.8	21.5	7.3	0.14	100	1491940000
4 - 6	yellow	6.3	0.8	24.2	7.3	0.20	100	1491950000



Cable lug connector / piggy back disconnectors

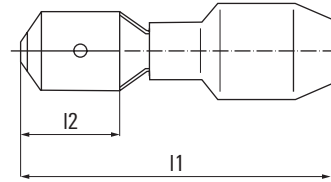

Cable lug connector 0.5 – 6 mm<sup>2</sup>

Technical data

Material:	MS
Insulation:	PVC
Surface:	tin plated

Ordering data

Cross-section mm <sup>2</sup>	colour of insulation	tab- width	tab- thickness	dimensions in mm		Cu-weight 100 pcs./kg	Qty. (pcs.)	Order No.
				I1	I2			
0.5	red	2.8	0.8	19.2	6.5	0.08	100	1491790000
		4.8	0.8	19.8	6.7	0.08	100	1491810000
		6.3	0.8	21.8	7.7	0.09	100	1491820000
1.5 - 2.5	blue	4.8	0.8	19.8	6.7	0.09	100	1491850000
		6.3	0.8	21.8	7.7	0.1	100	1491830000
4 - 6	yellow	6.3	0.8	24	7.7	0.17	100	1491840000

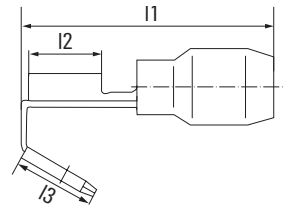
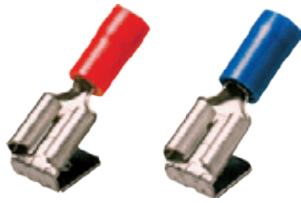

Piggy back disconnectors 0.5 – 2.5 mm<sup>2</sup>

Technical data

Material:	MS
Insulation:	PVC
Surface:	tin plated

Ordering data

Cross-section mm <sup>2</sup>	colour of insulation	tab- width	tab- thickness	dimensions in mm			Cu-weight 100 pcs./kg	Qty. (pcs.)	Order No.
				I1	I2	I3			
0.5 - 1	red	6.3	0.8	23.9	8	8.2	0.15	100	1491770000
1.5 - 2.5	blue	6.3	0.8	23	8	8.2	0.15	100	1491780000

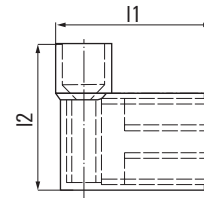
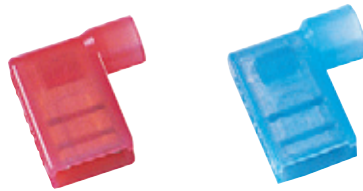

### Flag female disconnectors 0.5 – 2.5 mm<sup>2</sup>, completely insulated

#### Technical data

Material:	MS
Insulation:	PVC
Surface:	tin plated

#### Ordering data

Cross-section mm <sup>2</sup>	colour of insulation	dimensions in mm			Cu-weight 100 pcs./kg	Qty. (pcs.)	Order No.	
		tab- width	tab- thickness	l1				l2
0.5 - 1	red	6.3	0.8	16.3	15	0.14	100	1491960000
1.5 - 2.5	blue	6.3	0.8	16.8	15	0.13	100	1491970000

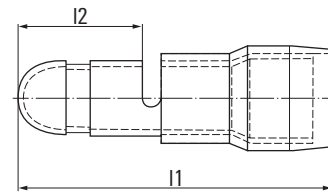

### Circular plug 0.5 – 6 mm<sup>2</sup>

#### Technical data

Material:	MS
Insulation:	PVC
Surface:	tin plated

#### Ordering data

Cross-section mm <sup>2</sup>	colour of insulation	pin Ø	dimensions in mm		Cu-weight 100 pcs./kg	Qty. (pcs.)	Order No.
			l1	l2			
0.5 - 1	red	4	21.5	8.5	0.1	100	1492040000
1.5 - 2.5	blue	5	21.2	8.5	0.11	100	1492050000
4 - 6	yellow	5	24	8.5	0.17	100	1492060000

## Round-plug sleeves

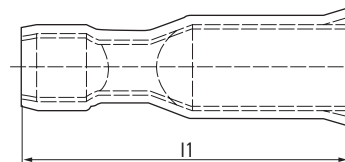

### Round-plug sleeves 0.5 - 6 mm<sup>2</sup>

#### Technical data

Material:	MS
Insulation:	PVC
Surface:	tin plated

#### Ordering data

Cross-section mm <sup>2</sup>	colour of insulation	dimensions in mm		Cu-weight 100 pcs./kg	Qty. (pcs.)	Order No.
		pin Ø	l1			
0.5 - 1	red	4	23.3	0.13	100	1491980000
1.5 - 2.5	blue	5	23.3	0.15	100	1491990000
4 - 6	yellow	5	25.1	0.23	100	1492010000

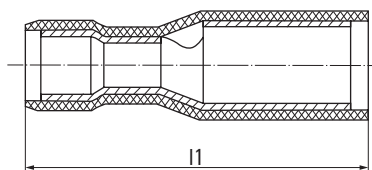
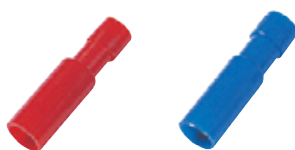

### Round-plug sleeves 0.5 - 2.5 mm<sup>2</sup>, completely insulated

#### Technical data

Material:	MS
Insulation:	PA
Surface:	tin plated

#### Ordering data

Cross-section mm <sup>2</sup>	colour of insulation	dimensions in mm		Cu-weight 100 pcs./kg	Qty. (pcs.)	Order No.
		pin Ø	l1			
0.5 - 1	red	4	25.2	0.12	100	1492020000
1.5 - 2.5	blue	4	25.2	0.13	100	1492030000

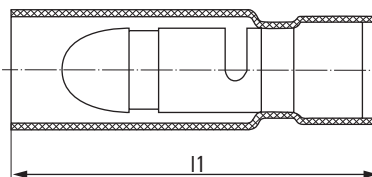

### Round-plug sleeves 0.5 - 6 mm<sup>2</sup> completely insulated

#### Technical data

Material:	MS
Insulation:	PVC
Surface:	tin plated

#### Ordering data

Cross-section mm <sup>2</sup>	colour of insulation	dimensions in mm		Cu-weight 100 pcs./kg	Qty. (pcs.)	Order No.
		pin Ø	l1			
0.5 - 1	red	4	27	0.13	100	1492070000
1.5 - 2.5	blue	4	27	0.15	100	1492080000

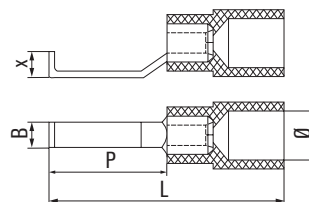

**Insulated hook-type cable lug**

**Technical data**

Material: copper  
 Insulation: PC  
 Surface: tin plated

**Ordering data**

Cross-section mm <sup>2</sup>	colour of insulation	dimensions in mm				Cu- weight 100 pcs./kg	Qty. (pcs.)	Order No.
		Ø	x	L	P			
0.5 - 1.5	red	4	2.1	28.4	17.4	0.74	100	1233340000
0.5 - 1.5	red	4	2.1	28.4	17.4	0.88	100	1312440000
1.5 - 2.5	blue	4.5	2.1	28.2	17.4	1.05	100	1233330000
1.5 - 2.5	blue	4.5	2.1	28.2	17.4	0.88	100	1312450000
4.0 - 6.0	yellow	6.4	2.8	30.2	17.2	1.59	100	1312470000
4.0 - 6.0	yellow	6.4	2.8	30.2	17.2	1.825	100	1216230000





# Index

<b>Index</b>	Index Type	X.2
	Index Order No.	X.8
	Addresses worldwide	X.16

Type	Order No.	Page
<b>0-9</b>		
1/4" Handgriff	4294820000	F.15
<b>A</b>		
AIE M-SPX 0.25-1.5 S	9204550000	C.11
AIE M-SPX 1.5-6.0 S	9204570000	C.11
AIE multi-spx 0.75-4*SL	9203730000	C.11
AIE multi-stripax 16 SL	9202270000	C.11
AIE multi-stripax 6-16	9202260000	C.11
AIE multi-stripax ASI	9202300000	C.11
AIE multi-stripax AWG	9202280000	C.11
AIE multi-stripax GKWLW	9205770000	C.11
AIE MULTI-STRIPAX PDF	1212770000	C.11
AIE MULTI-STRIPAX PV	1204280000	C.11
AKKU APG/AKT	1502140000	D.41
AKKU APG/AKT	1502140000	D.44
AKKU APG/AKT	1502140000	D.49
AKKU DMS 3	9007450000	F.7
AKKU DMS PRO	1479110000	F.6
AKKU EPG 45	1500840000	D.35
AKKU EPG 45	1500840000	D.49
AKT 50	1502190000	D.48
AM 12	9030060000	C.12
AM 16	9026120000	C.13
AM 25	9001540000	C.12
AM 35	9001080000	C.12
AM 35	9001080000	C.12
AM LWL/PDF	9020360000	D.54
AMF 6/10	9204180000	C.13
APG 55	1501390000	D.41
APG 55 120V	1508790000	D.41
APG 80	1502390000	D.44
APG 80 120V	1508820000	D.44
<b>B</b>		
BATTERIE 1,5V MICRO	9201310000	G.6
BATTERIE 1,5V MICRO	9201310000	G.6
BATTERIE 1,5V MICRO	9201310000	G.7
BATTERIE 1,5V MICRO	9201310000	G.8
BATTERIE 1,5V MICRO	9201310000	G.8
BATTERIE 1,5V MICRO	9201310000	G.9
BATTERIE 1,5V MICRO	9201310000	G.18
BATTERIE 1,5V MICRO	9201310000	G.18
BHS 1/4	9009630000	F.9
BIT E6,3 0,4x2,5x70	9202750000	F.8
BIT E6,3 0,5x3,0x70	9024000000	F.8
BIT E6,3 0,6x3,5x70	9024020000	F.8
BIT E6,3 0,8x4,5x110	9205630000	F.8
BIT E6,3 0,8x4,0x70	9024030000	F.8
BIT E6,3 1,0x5,5x70	9024040000	F.8
BIT E6,3 1,2x6,5x70	9202740000	F.8
BIT E6,3 PH1x70	9024080000	F.8
BIT E6,3 PH2x70	9024090000	F.8
BIT E6,3 PZ1x70	9024100000	F.8
BIT E6,3 PZ2x70	9024110000	F.8
BIT E6,3 T15	1318350000	F.8
BIT E6,3 T20	1318370000	F.8
BIT E6,3 T40	1318380000	F.8
BIT E6,3 0.5x3.0x110	9205660000	F.8
BIT E6,3 0.8x3.5x110	9205610000	F.8
BIT E6,3 0.8x4.0x110	9205620000	F.8
BIT E6,3 1.0x5.5x110	9205640000	F.8
BIT E6,3 1.2x6.5x110	9205650000	F.8
BIT E6,3Z 0.6x3.5x70	9205670000	F.8
BIT E6,3Z 0.8x4.0x70	9205660000	F.8
Bit-Box WI DMS 3	9024970000	F.9
BLOCKBATTERIE 9V	9004810000	G.13
BLOCKBATTERIE 9V	9004810000	G.13
BLOCKBATTERIE 9V	9004810000	G.14
BLOCKBATTERIE 9V	9004810000	G.15
BLOCKBATTERIE 9V	9004810000	G.15
<b>C</b>		
CAR-CHECK	9918970000	G.11
CCM ABLAENGAUTOMAT	9025440000	I.5
COMBI CHECK	9918980000	G.8
Combi Check 2MM	9204230000	G.8
COMBI CHECK PRO	1279330000	G.8
COMBI CHECK PRO 2MM	1279550000	G.8
CRIMPFIX 2.5 M	9205410000	1.9
CRIMPFIX L	9028530000	1.10
CRIMPFIX LS	9028540000	1.10
CRIMPFIX LZ	9027310000	1.10
CRIMPFIX R	9028500000	1.9
CRIMPFIX RS	1477030000	1.9
Crimpsset CTI 6	9202600000	H.9
Crimps-Set Kontakte	9202640000	H.10
Crimpsset PZ / CTI	9202610000	H.10
CRIMP-SET PZ 16	9025850000	H.7
CRIMP-SET PZ 16 D	9028800000	H.7
CRIMP-SET PZ 16 T	9028810000	H.7
CRIMP-SET PZ 3	9028650000	H.6
CRIMP-SET PZ 3 D	9028660000	H.6
CRIMP-SET PZ 3 T	9028670000	H.6
CRIMP-SET PZ 4	9025800000	H.6
CRIMP-SET PZ 4 D	9028630000	H.6

Type	Order No.	Page
CRIMP-SET PZ 4 T	9028640000	H.6
CRIMP-SET PZ 50	9028850000	H.8
CRIMP-SET PZ 50 D	9028870000	H.8
CRIMP-SET PZ 50 T	9028880000	H.8
CRIMP-SET PZ 6 ROTO L	9028680000	H.6
CRIMP-SET PZ 6 ROTO L D	9028690000	H.6
CRIMP-SET PZ 6 ROTO L T	9028700000	H.6
CRIMP-SET PZ 6/5	9028740000	H.7
CRIMP-SET PZ 6/5 D	9028750000	H.7
CRIMP-SET PZ 6/5 T	9028760000	H.7
CRIMP-SET PZ ZH 16	9028820000	H.8
CRIMP-SET PZ ZH 16 D	9028830000	H.8
CRIMP-SET PZ ZH 16 T	9028840000	H.8
CRIMP-SET STRIPAX PLUS	9028770000	H.7
CRIMP-SET STRIPAX PLUS D	9028780000	H.7
CRIMP-SET STRIPAX PLUS T	9028790000	H.7
CROSS-KEY MASTER	9918150000	F.29
CROSS-KEY UNIVERSAL	9918130000	F.29
CROSS-KEY UNIVERSAL S	9918140000	F.29
CST	9030500000	C.14
CST VARIO	9005700000	C.15
CTF 63	9202860000	D.16
CTF 63	9202860000	D.5
CTF 63 ZERT	1077010000	D.16
CTF PV WM4	1222870000	D.24
CTI 6	9006120000	D.17
CTI 6	9006120000	D.5
CTI 6	9006120000	J.3
CTI 6 G	9202850000	D.17
CTI 6 G	9202850000	D.5
CTI 6 G	9202850000	J.3
CTI 6 G ZERT	1292880000	D.17
CTI 6 ZERT	9017290000	D.17
CTIN CM 1.6/2.5	9205430000	D.20
CTIN CM 1.6/2.5	9205430000	D.4
CTIN CM 3.6	9205440000	D.20
CTIN CM 3.6	9205440000	D.4
CTN 25 D4	9006220000	D.19
CTN 25 D4	9006220000	D.5
CTN 25 D4 ZERT	9017350000	D.19
CTN 25 D5	9006230000	D.19
CTN 25 D5	9006230000	D.5
CTN 25 D5 ZERT	1292870000	D.19
CTX 500	9006320000	D.26
CTX 500	9006320000	D.5
CTX 501	9006370000	D.26
CTX 501	9006370000	D.5
CTX 502	9006380000	D.26
CTX 502	9006380000	D.5
CTX CM 1.6/2.5	9018490000	D.20
CTX CM 1.6/2.5	9018490000	D.4
CTX CM 1.6/2.5 ZERT	9013690000	D.20
CTX CM 3.6	9018480000	D.20
CTX CM 3.6	9018480000	D.4
CTX CM 3.6 ZERT	1270320000	D.20
CUTFIX 8	9023100000	1.5
<b>D</b>		
DIFF-CENTRIERUNGSSWZ.	9014210000	D.52
DIGI CHECK	9918950000	G.6
Digi Check 2MM	9201590000	G.6
DIGI CHECK PRO	9918970000	G.6
Digi Check Pro 2MM	9201580000	G.6
DMS 3	9007440000	F.7
DMS 3 ZERT	9017870000	F.7
DMS MANUELL 0,5-1,7	9918370000	F.11
DMS MANUELL 2,0-8,0	9918380000	F.11
DMS PRO	1479120000	F.6
DMSI MANUELL 0,5-1,7	9918390000	F.12
DMSI MANUELL 2,0-8,0	9918400000	F.12
DW RSV 1.6	9004530000	D.52
<b>E</b>		
EINSATZ A7-1 CL55	9028450000	H.12
EINSATZ A8-1 CL55	9028460000	H.12
EINSATZ A8-2 CL55	9028420000	H.12
EINSATZ A9-1 CL55	9202020000	H.12
EINSATZ A9-2 CL55	9203260000	H.12
EINSATZ BA7-PSC 80	9202320000	H.13
EINSATZ BA8-PSC 80	9202310000	H.13
EINSATZ MTR 160 10+25WM	9021750000	D.40
EINSATZ MTR 160 10DIN	9021300000	D.40
EINSATZ MTR 160 10HEX	9020900000	D.40
EINSATZ MTR 160 120DIN	9021370000	D.40
EINSATZ MTR 160 120HEX	9020970000	D.40
EINSATZ MTR 160 120WM	9021800000	D.40
EINSATZ MTR 160 150DIN	9021380000	D.40
EINSATZ MTR 160 150HEX	9020980000	D.40
EINSATZ MTR 160 150WM	9021810000	D.40
EINSATZ MTR 160 16+35WM	9021760000	D.40
EINSATZ MTR 160 16DIN	9021310000	D.40
EINSATZ MTR 160 16HEX	9020910000	D.40
EINSATZ MTR 160 185HEX	9020990000	D.40
EINSATZ MTR 160 185WM	9021820000	D.40
EINSATZ MTR 160 240HEX	9021000000	D.40
EINSATZ MTR 160 240WM	9021830000	D.40
EINSATZ MTR 160 25DIN	9021320000	D.40
EINSATZ MTR 160 25HEX	9020920000	D.40
EINSATZ MTR 160 35HEX	9020930000	D.40
EINSATZ MTR 160 50DIN	9021340000	D.40
EINSATZ MTR 160 50HEX	9020940000	D.40
EINSATZ MTR 160 50WM	9021770000	D.40
EINSATZ MTR 160 70DIN	9021350000	D.40
EINSATZ MTR 160 70HEX	9020950000	D.40
EINSATZ MTR 160 70WM	9021780000	D.40
EINSATZ MTR 160 95DIN	9021360000	D.40
EINSATZ MTR 160 95HEX	9020960000	D.40
EINSATZ MTR 160 95WM	9021790000	D.40
EINSATZP.HEX10QMM	9021430000	D.40
EINSATZP.HEX120QMM	9022300000	D.40
EINSATZP.HEX150QMM	9022310000	D.40
EINSATZP.HEX160QMM	9021440000	D.40
EINSATZP.HEX185QMM	9022320000	D.40
EINSATZP.HEX240QMM	9022330000	D.40
EINSATZP.HEX25QMM	9021450000	D.40
EINSATZP.HEX300QMM	9022340000	D.40
EINSATZP.HEX350QMM	9021460000	D.40
EINSATZP.HEX50QMM	9021470000	D.40
EINSATZP.HEX70QMM	9021480000	D.40
EINSATZP.HEX95QMM	9022290000	D.40
EINSATZP.WM 10+25QMM	9024010000	D.40
EINSATZP.WM 120QMM	9025210000	D.40
EINSATZP.WM 150QMM	9025220000	D.40
EINSATZP.WM 16+35QMM	9024400000	D.40
EINSATZP.WM 185QMM	9025230000	D.40
EINSATZP.WM 240QMM	9028020000	D.40
EINSATZP.WM 50QMM	9024410000	D.40
EINSATZP.WM 70QMM	9024420000	D.40
EINSATZP.WM 95QMM	9024430000	D.40
EINSATZPAAR ISO 100QMM	9016180000	D.40
EINSATZPAAR ISO 160QMM	9016190000	D.40
EINSATZPAAR ISO 25QMM	9016200000	D.40
EINSATZPAAR ISO 35QMM	9016210000	D.40
EINSATZPAAR ISO 50QMM	9016220000	D.40
EINSATZPAAR ISO 70QMM	9016230000	D.40
INSTELLBLOCK CST	9005800000	C.14
EPG 45	1500830000	D.35
EPG 45 120V	1508780000	D.35
ERAN MULTI-STRIPAX	9203100000	C.10
ERME 10" SPX 4	1119030000	C.4
ERME 110 PTD	9013960000	D.51
ERME 16" SPX 4	1119040000	C.4
ERME 630 PTD	9013990000	D.51
ERME 66 PTD	9013980000	D.51
ERME AM 16	9204260000	C.13
ERME AMF 6/10	9204250000	C.13
ERME KT 45 R	9204270000	B.7
ERME KT 55 R	9204280000	B.7
ERME KT 80	9204290000	B.8
ERME LSA PLUS SCHERE	9014050000	D.51
ERME LSA PLUS STANDARD	9014000000	D.51
ERME MULTI-STRIPAX	9203070000	C.10
ERME SPX UL	1471390000	C.5
ERME SPX UL XL	1512790000	C.5
ERME VKSW	1251270000	B.10
ERSATZMESSER AM 25/35	9001530000	C.12
ERSATZMESSER STRIPAX PL	9050340000	D.6
ERSATZMESSERSATZ TT864	9008130000	D.29
ERSATZMESSERSATZ TT864	9008130000	D.29
ES APG/HPG55 AEH 10	1502280000	D.43
ES APG/HPG55 AEH 120	1502380000	D.43
ES APG/HPG55 AEH 16	1502290000	D.43
ES APG/HPG55 AEH 25	1502300000	D.43
ES APG/HPG55 AEH 50	1502330000	D.43
ES APG/HPG55 AEH 6	1502270000	D.43
ES APG/HPG55 AEH 70	1502340000	D.43
ES APG/HPG55 AEH 95	1502370000	D.43
ES APG/HPG55 AEH35	1502320000	D.43
ES APG/HPG55 DIN 10	1501640000	D.43
ES APG/HPG55 DIN 120	1501730000	D.43
ES APG/HPG55 DIN 16	1501650000	D.43
ES APG/HPG55		

Type	Order No.	Page
ES MTR110 WM 10/70	1500870000	D.37
ES MTR110 WM 120	1500900000	D.37
ES MTR110 WM 16/35	1500920000	D.37
ES MTR110 WM 25/50	1500880000	D.37
ES MTR110 WM 6	1500850000	D.37
ES MTR110 WM 95	1500890000	D.37
ES MTR35 AEH 10	1500770000	D.34
ES MTR35 AEH 16	1500780000	D.34
ES MTR35 AEH 25	1500790000	D.34
ES MTR35 AEH 35	1500800000	D.34
ES MTR35 AEH 50	1500820000	D.34
ES MTR35 AEH 6	1500750000	D.34
ES MTR35 DIN 10	1500670000	D.34
ES MTR35 DIN 16	1500680000	D.34
ES MTR35 DIN 25	1500690000	D.34
ES MTR35 DIN 35	1500700000	D.34
ES MTR35 DIN 6	1500650000	D.34
ES MTR35 HEX 10	1500690000	D.34
ES MTR35 HEX 16	1500660000	D.34
ES MTR35 HEX 25	1500620000	D.34
ES MTR35 HEX 35	1500630000	D.34
ES MTR35 HEX 50	1500640000	D.34
ES MTR35 HEX 6	1500580000	D.34
ES MTR35 ISO 10	1500720000	D.34
ES MTR35 ISO 16	1500730000	D.34
ES MTR35 ISO 25	1500740000	D.34
ES MTR35 WM 10	1500500000	D.34
ES MTR35 WM 16	1500520000	D.34
ES MTR35 WM 25	1500530000	D.34
ES MTR35 WM 35	1500540000	D.34
ES MTR35 WM 50	1500550000	D.34
ES MTR35 WM 6	1500490000	D.34

## F

FLECAFIX 11/24	9015900000	F.16
FLECAFIX 24/36	9015980000	F.16
FRZ S 160	9046370000	E.5
FRZ S 200	9046380000	E.5
FRZ SG 160	9046390000	E.5
FRZ SG 200	9046400000	E.5
FSKI/0,5-1,0/288	1491790000	K.32
FSKI/0,5-1,0/488	1491810000	K.32
FSKI/0,5-1,0/638	1491820000	K.32
FSKI/1,5-2,5/488	1491850000	K.32
FSKI/1,5-2,5/638	1491830000	K.32
FSKI/4,0-6,0/638	1491840000	K.32
FZ 160	9046350000	E.6
FZE ESD 130	9204760000	E.8

## G

GESENK 10+70QMM	9022350000	D.40
GESENK 120QMM	9022390000	D.40
GESENK 150QMM	9022400000	D.40
GESENK 16+35QMM	9022360000	D.40
GESENK 25+50QMM	9022370000	D.40
GESENK 95QMM	9022380000	D.40

## H

H 0,5/16 S OR	9202900000	J.14
H 10,0/22 S EB	9203620000	J.14
H 4,0/20 DS GR	9203630000	J.14
H 10,14/10 GR SV	9005180000	J.4
H 10,14/10T BR SV	9028250000	J.8
H 10,14/12 GR SV	9028240000	J.4
H 0,25/10 HBL	9025740000	J.4
H 0,25/10 HBL SV	9026050000	J.4
H 0,25/10T GE	9021010000	J.8
H 0,25/10T GE SV	9021210000	J.8
H 0,25/12 HBL	9025760000	J.4
H 0,25/12 HBL SV	9025780000	J.4
H 0,25/12T GE	9021020000	J.8
H 0,25/12T GE SV	9021220000	J.8
H 0,25/5	9018910000	J.15
H 0,34/10 TK	9025750000	J.4
H 0,34/10 TK SV	9026030000	J.4
H 0,34/11 S TK	9204090000	J.14
H 0,34/12 TK	9025770000	J.4
H 0,34/12 TK BD GSP	9004390000	J.5
H 0,34/12 TK SV	9025790000	J.4
H 0,34/14 ZH TK	1139070000	J.10
H 0,5/10	9004050000	J.15
H 0,5/12 OR	0040950000	J.4
H 0,5/12 OR SV	9028260000	J.4
H 0,5/120 W	9019000000	J.6
H 0,5/120 W	9019000000	J.8
H 0,5/14 OR	0690700000	J.4
H 0,5/14 OR BD	9004470000	J.5
H 0,5/14 OR BD GSP	9005810000	J.5
H 0,5/14 OR SV	9026060000	J.4
H 0,5/14 ZH OR	9037200000	J.10
H 0,5/14 ZH OR SV	9004440000	J.10
H 0,5/140 W	9019010000	J.6
H 0,5/140 W	9019010000	J.8
H 0,5/140 W BD	9004280000	J.6
H 0,5/140 W BD	9004280000	J.8

Type	Order No.	Page
H 0,5/140 W BD GSP	9005860000	J.7
H 0,5/140 W BD GSP	9005860000	J.9
H 0,5/140 W SV	9019400000	J.6
H 0,5/140 W SV	9019400000	J.8
H 0,5/140 ZH W	9037380000	J.11
H 0,5/140 ZH W SV	9004780000	J.11
H 0,5/14S OR	9004560000	J.14
H 0,5/14S W	9004590000	J.14
H 0,5/16 DS W	9020910000	J.14
H 0,5/16 OR	9025870000	J.4
H 0,5/16 OR SV	9028270000	J.4
H 0,5/16 ZH OR	9037210000	J.10
H 0,5/16 ZH OR	9037210000	J.12
H 0,5/160 W	9019020000	J.6
H 0,5/160 W	9019020000	J.8
H 0,5/160 ZH W	9037390000	J.11
H 0,5/18 ZH OR	9037220000	J.10
H 0,5/18 ZH OR	9037220000	J.12
H 0,5/180 ZH W	9037400000	J.11
H 0,5/6	0282600000	J.15
H 0,75/10	0542500000	J.15
H 0,75/12 W	0409600000	J.4
H 0,75/12 W SV	9028280000	J.4
H 0,75/12D GR	9019030000	J.6
H 0,75/12D GR	9019030000	J.8
H 0,75/14 W	0462900000	J.4
H 0,75/14 W BD	9004290000	J.5
H 0,75/14 W BD GSP	9005820000	J.5
H 0,75/14 W SV	9026070000	J.4
H 0,75/14 ZH W	9037230000	J.10
H 0,75/14 ZH W SV	9018510000	J.10
H 0,75/140 GR	9019040000	J.6
H 0,75/140 GR	9005870000	J.7
H 0,75/140 GR BD	9004300000	J.6
H 0,75/140 GR SV	9019410000	J.6
H 0,75/140 ZH GR	9037410000	J.11
H 0,75/140 ZH GR SV	9018520000	J.11
H 0,75/140S GR	9028580000	J.14
H 0,75/14S W	9025960000	J.14
H 0,75/14S W SV	9025700000	J.14
H 0,75/14T ZH HBL	9037610000	J.12
H 0,75/14T BL BD GSP	9005900000	J.9
H 0,75/14T HBL BD	9004310000	J.8
H 0,75/14T HBL SV	9021230000	J.8
H 0,75/14TS HBL	9018550000	J.14
H 0,75/15S HBL	9204240000	J.14
H 0,75/16 W	9025860000	J.4
H 0,75/16 W SV	9028290000	J.4
H 0,75/16 ZH W	9037240000	J.10
H 0,75/16 ZH W SV	9004800000	J.10
H 0,75/160 GR	9019050000	J.6
H 0,75/160 ZH GR	9037420000	J.11
H 0,75/160 ZH GR SV	9004770000	J.11
H 0,75/16T HBL	9021050000	J.8
H 0,75/16T ZH HBL	9037620000	J.12
H 0,75/16T ZH HBL SV	9005140000	J.12
H 0,75/18 W	9025919000	J.4
H 0,75/18 W SV	9028300000	J.4
H 0,75/180 GR	9019060000	J.6
H 0,75/18T HBL	9021060000	J.8
H 0,75/19DS ZH GR	9020830000	J.11
H 0,75/19S ZH W	9202820000	J.10
H 0,75/19TS ZH HBL	9202840000	J.12
H 0,75/24 ZH W	9037250000	J.10
H 0,75/24D ZH GR	9037430000	J.11
H 0,75/24T ZH HBL	9037630000	J.12
H 0,75/6	0282700000	J.15
H 0,5/18 OR	1076980000	J.4
H 0,5/180 W	1076990000	J.6
H 0,75/14 HBL	9021040000	J.8
H 1,0/10	0282800000	J.15
H 1,0/12 GE	0409700000	J.4
H 1,0/12 GE SV	9028310000	J.4
H 1,0/120 R	9019070000	J.6
H 1,0/14 GE	0463000000	J.4
H 1,0/14 GE BD	9004320000	J.5
H 1,0/14 GE BD GSP	9005830000	J.5
H 1,0/14 GE SV	9026080000	J.4
H 1,0/140 R	9019080000	J.6
H 1,0/140 R BD	9004330000	J.6
H 1,0/140 R BD	9004330000	J.8
H 1,0/140 R BD GSP	9005800000	J.7
H 1,0/140 R BD GSP	9005800000	J.9
H 1,0/140 R SV	9019420000	J.6
H 1,0/140 R SV	9019420000	J.8
H 1,0/14S GE	9025970000	J.14
H 1,0/14S GE SV	9025710000	J.14
H 1,0/14S R	9018560000	J.14
H 1,0/15 ZH GE	9037260000	J.10
H 1,0/15 ZH GE SV	9018530000	J.10
H 1,0/150 ZH R	9037440000	J.11
H 1,0/150 ZH R	9037440000	J.12
H 1,0/150 ZH R SV	9018540000	J.11
H 1,0/150 ZH R SV	9018540000	J.12
H 1,0/15S ZH GE	9018690000	J.10
H 1,0/15S ZH GE SV	9018650000	J.10
H 1,0/16 GE	9025950000	J.4
H 1,0/16 GE SV	9028320000	J.4
H 1,0/160 R	9019100000	J.6

Type	Order No.	Page
H 1,0/160 R	9019100000	J.8
H 1,0/18 GE	9025930000	J.4
H 1,0/18 GE SV	9028340000	J.4
H 1,0/180 R	9019110000	J.6
H 1,0/180 R	9019110000	J.8
H 1,0/19 ZH GE	9037270000	J.10
H 1,0/19 ZH GE SV	9004910000	J.10
H 1,0/190 ZH R	9037450000	J.11
H 1,0/190 ZH R	9037450000	J.12
H 1,0/190 ZH R SV	9004760000	J.11
H 1,0/190 ZH R SV	9004760000	J.12
H 1,0/220S R ZH	9036330000	J.11
H 1,0/25 ZH GE	9037280000	J.10
H 1,0/250 ZH R	9037460000	J.11
H 1,0/250 ZH R	9037460000	J.12
H 1,0/6	0372600000	J.15
H 1,0/6	0186500000	J.15
H 1,5/12	9004060000	J.15
H 1,5/12S R	9025690000	J.14
H 1,5/14 R	0463100000	J.4
H 1,5/14 R BD	9004340000	J.5
H 1,5/14 R BD GSP	9005840000	J.5
H 1,5/14 R SV	9026090000	J.4
H 1,5/140 SW	9019120000	J.6
H 1,5/140 SW	9019120000	J.8
H 1,5/140 SW BD	9004350000	J.6
H 1,5/140 SW BD	9004350000	J.8
H 1,5/140 SW BD GSP	9005890000	J.7
H 1,5/140 SW BD GSP	9005890000	J.9
H 1,5/140 SW SV	9019430000	J.6
H 1,5/140 SW SV	9019430000	J.8
H 1,5/140S SW SV	9028360000	J.14
H 1,5/14S R	9025980000	J.14
H 1,5/14S R SV	9025720000	J.14
H 1,5/14S SW	9025240000	J.14
H 1,5/16 R	0635100000	J.4
H 1,5/16 R SV	9028350000	J.4
H 1,5/16 ZH R	9037290000	J.10
H 1,5/16 ZH R SV	9004410000	J.10
H 1,5/160 SW	9019130000	J.6
H 1,5/160 SW	9019130000	J.8
H 1,5/160 ZH W	9037470000	J.11
H 1,5/160 ZH W SV	9037470000	J.12
H 1,5/160 ZH SW	9004420000	J.11
H 1,5/160 ZH SW SV	9004420000	J.12
H 1,5/17,5X SW SV	9006590000	J.13
H 1,5/18 W	9004070000	J.15
H 1,5/180 SW	9019140000	J.6
H 1,5/180 SW	9019140000	J.8
H 1,5/19,5X SW SV	9006630000	J.13
H 1,5/20 ZH R	9037300000	J.10
H 1,5/20 ZH R SV	9004920000	J.10
H 1,5/200 SW ZH SV	9004750000	J.11
H 1,5/200 SW ZH SV	9004750000	J.12
H 1,5/200 ZH SW	9037480000	J.11
H 1,5/200 ZH SW	9037480000	J.12
H 1,5/24 R	0565600000	J.4
H 1,5/24 XS SW	9202870000	J.13
H 1,5/240 SW	9019150000	J.6
H 1,5/240 SW	9019150000	J.8
H 1,5/26 ZH R	9037310000	J.10
H 1,5/260 ZH SW	9037490000	J.11
H 1,5/260 ZH SW	9037490000	J.12
H 1,5/7	0372700000	J.15
H 10,0/12	0282900000	J.15
H 10,0/15	0124800000	J.15
H 10,0/18	0379300000	J.15
H 10,0/22 EB	0534200000	J.4
H 10,0/220 R	9019240000	J.6
H 10,0/22T BR	9021150000	J.8
H 10,0/24 ZH EB	9037340000	J.10
H 10,0/24 ZH EB SV	9004940000	J.10
H 10,0/24,0X R SV	9006830000	J.13
H 10,0/240 ZH R	9037570000	J.11
H 10,0/240S ZH R	9018880000	J.11
H 10,0/24T ZH BR	9037710000	J.12
H 10,0/260 ZH SV	9004710000	J.11
H 10,0/26T ZH BR SV	9005170000	J.12
H 10,0/28 EB	0565800000	J.4
H 10,0/280 R	9019250000	J.6
H 10,0/28T BR	9021160000	J.8
H 10,0/30 ZH EB	9037350000	J.10
H 10,0/300 ZH R	9037580000	J.11
H 10,0/30T ZH BR	9037720000	J.12
H 10,0/24S ZH EB	9018860000	J.10
H 10,0/30DS ZH R	9018890000	J.11
H 10,0/30S ZH EB	9018870000	J.10
H 120,0/32	9036240000	J.15
H 120,0/50 BL	9028220000	J.4
H 150,0/32	9036250000	J.15
H 150,0/54 GE		





Type	Order No.	Page
KQN-M2/0,5	1493670000	K.21
KQN-M2/-1	1493720000	K.21
KQN-M20/120	1493360000	K.22
KQN-M20/150	1493410000	K.22
KQN-M20/185	1493450000	K.22
KQN-M20/35	1493520000	K.22
KQN-M20/50	1493530000	K.22
KQN-M20/70	1493250000	K.22
KQN-M20/95	1493310000	K.22
KQN-M3,5/-1	1493750000	K.21
KQN-M3,5/2,5	1493830000	K.21
KQN-M3/0,5	1493680000	K.21
KQN-M3/-1	1493740000	K.21
KQN-M3/2,5	1493820000	K.21
KQN-M4/0,5	1493690000	K.21
KQN-M4/-1	1493770000	K.21
KQN-M4/10	1494010000	K.22
KQN-M4/2,5	1493850000	K.22
KQN-M4/6	1493950000	K.21
KQN-M4/S/-1	1493760000	K.21
KQN-M4/S/2,5	1493840000	K.21
KQN-M5/0,5	1493700000	K.21
KQN-M5/-1	1493790000	K.21
KQN-M5/10	1494020000	K.22
KQN-M5/16	1494070000	K.22
KQN-M5/2,5	1493890000	K.21
KQN-M5/25	1494120000	K.22
KQN-M5/6	1493960000	K.21
KQN-M5/S/-1	1493780000	K.21
KQN-M5/S/2,5	1493870000	K.21
KQN-M6/-1	1493800000	K.21
KQN-M6/10	1494030000	K.22
KQN-M6/16	1494080000	K.22
KQN-M6/25	1493900000	K.21
KQN-M6/35	1494130000	K.22
KQN-M6/50	1494170000	K.22
KQN-M6/6	1493951000	K.21
KQN-M6/70	1493190000	K.22
KQN-M8/-1	1493810000	K.21
KQN-M8/10	1494040000	K.22
KQN-M8/120	1493320000	K.22
KQN-M8/16	1494090000	K.22
KQN-M8/2,5	1493910000	K.21
KQN-M8/25	1494140000	K.22
KQN-M8/35	1494180000	K.22
KQN-M8/50	1493150000	K.22
KQN-M8/6	1493980000	K.21
KQN-M8/70	1493210000	K.22
KQN-M8/95	1493260000	K.22
KRN-M10/10	1496940000	K.9
KRN-M10/120	1495650000	K.10
KRN-M10/120 S	1494920000	K.11
KRN-M10/150	1495710000	K.10
KRN-M10/150 S	1494950000	K.11
KRN-M10/16	1497000000	K.9
KRN-M10/185	1495430000	K.10
KRN-M10/185 S	1494980000	K.11
KRN-M10/240	1495490000	K.10
KRN-M10/240 S	1494340000	K.11
KRN-M10/25	1496510000	K.9
KRN-M10/300	1495530000	K.10
KRN-M10/300 S	1494380000	K.11
KRN-M10/35	1496570000	K.10
KRN-M10/50	1496610000	K.10
KRN-M10/50 S	1494840000	K.11
KRN-M10/6	1497200000	K.9
KRN-M10/70	1496670000	K.10
KRN-M10/70 S	1494870000	K.11
KRN-M10/95	1495610000	K.10
KRN-M10/95 S	1494900000	K.11
KRN-M12/10	1496950000	K.9
KRN-M12/120	1495670000	K.10
KRN-M12/120 S	1494930000	K.11
KRN-M12/150	1495720000	K.10
KRN-M12/150 S	1494970000	K.11
KRN-M12/16	1497010000	K.9
KRN-M12/185	1495440000	K.10
KRN-M12/185 S	1494990000	K.11
KRN-M12/240	1495500000	K.10
KRN-M12/240 S	1494350000	K.11
KRN-M12/25	1496520000	K.9
KRN-M12/300	1495540000	K.10
KRN-M12/300 S	1494390000	K.11
KRN-M12/35	1496580000	K.10
KRN-M12/50	1496620000	K.10
KRN-M12/6	1497210000	K.9
KRN-M12/70	1495570000	K.10
KRN-M12/70 S	1494880000	K.11
KRN-M12/95	1495620000	K.10
KRN-M12/95 S	1494910000	K.11
KRN-M14/120	1495800000	K.10
KRN-M14/150	1495810000	K.10
KRN-M14/185	1497250000	K.10
KRN-M14/240	1497270000	K.10
KRN-M14/25	1496530000	K.9
KRN-M14/300	1497280000	K.10
KRN-M14/50	1495750000	K.10
KRN-M14/70	1495770000	K.10

Type	Order No.	Page
KRN-M14/95	1495780000	K.10
KRN-M16/120	1495680000	K.10
KRN-M16/150	1495730000	K.10
KRN-M16/185	1495450000	K.10
KRN-M16/185 S	1495000000	K.11
KRN-M16/240	1495510000	K.10
KRN-M16/240 S	1494370000	K.11
KRN-M16/300	1495550000	K.10
KRN-M16/300 S	1494400000	K.11
KRN-M16/50	1496630000	K.10
KRN-M16/70	1495580000	K.10
KRN-M16/95	1495630000	K.10
KRN-M20/120	1495690000	K.10
KRN-M20/150	1495740000	K.10
KRN-M20/185	1495470000	K.10
KRN-M20/240	1495520000	K.10
KRN-M20/300	1497240000	K.10
KRN-M20/50	1495840000	K.10
KRN-M20/70	1495590000	K.10
KRN-M20/95	1495640000	K.10
KRN-M3/0,75	1495010000	K.9
KRN-M3/1,5	1495040000	K.9
KRN-M4/0,75	1495020000	K.9
KRN-M4/1,5	1495050000	K.9
KRN-M4/10	1496900000	K.9
KRN-M4/2,5	1495090000	K.9
KRN-M4/4	1495130000	K.9
KRN-M4/6	1495150000	K.9
KRN-M5/0,75	1495030000	K.9
KRN-M5/1,5	1495070000	K.9
KRN-M5/10	1496910000	K.9
KRN-M5/16	1496970000	K.9
KRN-M5/2,5	1495100000	K.9
KRN-M5/25	1495830000	K.9
KRN-M5/4	1495140000	K.9
KRN-M5/6	1495170000	K.9
KRN-M6/1,5	1495080000	K.9
KRN-M6/10	1496920000	K.9
KRN-M6/120 S	1494410000	K.11
KRN-M6/150 S	1494440000	K.11
KRN-M6/16	1496980000	K.9
KRN-M6/2,5	1495110000	K.9
KRN-M6/25	1496490000	K.9
KRN-M6/35	1496540000	K.10
KRN-M6/35 S	1494790000	K.11
KRN-M6/4	1495150000	K.9
KRN-M6/50	1496590000	K.10
KRN-M6/50 S	1494820000	K.11
KRN-M6/6	1497180000	K.9
KRN-M6/70	1496640000	K.10
KRN-M6/70 S	1494850000	K.11
KRN-M6/95	1495820000	K.10
KRN-M6/95 S	1494430000	K.11
KRN-M8/10	1496830000	K.9
KRN-M8/120	1495790000	K.10
KRN-M8/120 S	1494420000	K.11
KRN-M8/150	1495700000	K.10
KRN-M8/150 S	1494940000	K.11
KRN-M8/16	1496990000	K.9
KRN-M8/185	1497290000	K.10
KRN-M8/2,5	1495120000	K.9
KRN-M8/240	1495480000	K.10
KRN-M8/25	1496500000	K.9
KRN-M8/35	1496550000	K.10
KRN-M8/35 S	1494810000	K.11
KRN-M8/4	1495170000	K.9
KRN-M8/50	1496600000	K.10
KRN-M8/50 S	1494830000	K.11
KRN-M8/6	1497190000	K.9
KRN-M8/70	1496650000	K.10
KRN-M8/70 S	1494860000	K.11
KRN-M8/95	1495600000	K.10
KRN-M8/95 S	1494890000	K.11
KSE 160	9046410000	E.4
KSE 200	9046420000	E.4
KSI/0,1-0,5	1491370000	K.29
KSI/1,5-2,5	1491410000	K.29
KSI/-10	1491430000	K.29
KSI/-16	1491430000	K.29
KSI/-16	1491440000	K.29
KSI/0,4-0,6	1491420000	K.29
KSN/0,1-0,5	1492720000	K.24
KSN/0,5-1,0	1492730000	K.24
KSN/1,5-2,5	1492740000	K.24
KSN/-10	1492780000	K.24
KSN/-16	1492790000	K.24
KSN/2,5	1492750000	K.24
KSN/25	1492800000	K.24
KSN/35	1492810000	K.24
KSN/50	1492820000	K.24
KSN/6,0	1492770000	K.24
KSN/70	1492830000	K.24
KSN/95	1492840000	K.24
KT 12	9002660000	B.4
KT 14	1157820000	B.5
KT 22	1157830000	B.5
KT 45 R	9202040000	B.7
KT 55	9202060000	B.7

Type	Order No.	Page
KT 8	9002650000	B.4
KT 80	9202080000	B.8
KT 20V	9002170000	B.10
KTF 25	9002180000	B.6
KTF 36	9002190000	B.6
KWN-M10/10 45	1496840000	K.14
KWN-M10/10 90	1497050000	K.12
KWN-M10/120 45	1496400000	K.14
KWN-M10/120 90	1494450000	K.13
KWN-M10/150 45	1496440000	K.14
KWN-M10/150 90	1494500000	K.13
KWN-M10/16 45	1496890000	K.14
KWN-M10/16 90	1497110000	K.12
KWN-M10/185 45	1495340000	K.14
KWN-M10/185 90	1494540000	K.13
KWN-M10/240 90	1494590000	K.13
KWN-M10/25 45	1496200000	K.14
KWN-M10/25 90	1495880000	K.12
KWN-M10/35 45	1496240000	K.14
KWN-M10/35 90	1495930000	K.12
KWN-M10/50 45	1496290000	K.14
KWN-M10/50 90	1495980000	K.13
KWN-M10/6 90	1496150000	K.12
KWN-M10/70 45	1496320000	K.14
KWN-M10/70 90	1496030000	K.13
KWN-M10/95 45	1496350000	K.14
KWN-M10/95 90	1496090000	K.13
KWN-M12/10 90	1497070000	K.12
KWN-M12/120 45	1496410000	K.14
KWN-M12/120 90	1494470000	K.13
KWN-M12/150 90	1494510000	K.13
KWN-M12/16 90	1497120000	K.12
KWN-M12/185 45	1495350000	K.14
KWN-M12/185 90	1494550000	K.13
KWN-M12/240 45	1495400000	K.14
KWN-M12/240 90	1494610000	K.13
KWN-M12/25 90	1496210000	K.14
KWN-M12/25 90	1495890000	K.12
KWN-M12/300 90	1497300000	K.13
KWN-M12/35 45	1496250000	K.14
KWN-M12/35 90	1495940000	K.12
KWN-M12/50 45	1496300000	K.14
KWN-M12/50 90	1495990000	K.13
KWN-M12/6 90	1496170000	K.12
KWN-M12/70 45	1496330000	K.14
KWN-M12/70 90	1496040000	K.13
KWN-M12/95 45	1496370000	K.14
KWN-M12/95 90	1496100000	K.13
KWN-M14/25 90	1495900000	K.12
KWN-M14/35 90	1496440000	K.12
KWN-M14/50 90	1494650000	K.13
KWN-M14/70 90	1494660000	K.13
KWN-M14/95 90	1494670000	K.13
KWN-M16/120 45	1496420000	K.14
KWN-M16/120 90	1494480000	K.13
KWN-M16/150	1496470000	K.14
KWN-M16/150 45	1496450000	K.14
KWN-M16/150 90	1494520000	K.13
KWN-M16/185 45	1495370000	K.14
KWN-M16/185 90	1494570000	K.13
KWN-M16/240 45	1495410000	K.14
KWN-M16/240 90	1494620000	K.13
KWN-M16/300 90	1497310000	K.13
KWN-M16/35 90	1494690000	K.12
KWN-M16/50 90	1496000000	K.13
KWN-M16/70 90	1496050000	K.13
KWN-M16/95 45	1496380000	K.14
KWN-M16/95 90	1496110000	K.13
KWN-M20/150 45	1496480000	K.14
KWN-M20/150 90	1494530000	K.13
KWN-M20/185 45	1495380000	K.14
KWN-M20/185 90	1494580000	K.13
KWN-M20/240 45	1495420000	K.14
KWN-M20/240 90	1494630000	K.13
KWN-M20/300 90	1497320000	K.13
KWN-M20/50 90	1494710000	K.13
KWN-M20/70 90	1496070000	K.13
KWN-M3/0,75 90	1495180000	K.12
KWN-M3/1,5 90	1495210000	K.12
KWN-M4/0,75 90	1495190000	K.12
KWN-M4/1,5 90	1495220000	K.12
KWN-M4/2,5 90	1495250000	K.12
KWN-M4/4 90	1495300000	K.12
KWN-M5/0,75 90	1495200000	K.12
KWN-M5/1,5 90	1495230000	K.12
KWN-M5/10 45	1496810000	K.14
KWN-M5/10 90	1497020000	K.14
KWN-M5/16 45	1496850000	K.12
KWN-M5/16 90	1497080000	K.12
KWN-M5/2,5 90	1495270000	K.12
KWN-M5/4 90	1495310000	K.12
KWN-M5/6	1496120000	K.12
KWN-M5/6 90	1497220000	K.12
KWN-M6/1,5 90	1495240000	K.12
KWN-M6/10 45	1496820000	K.14
KWN-M6/10 90	1497030000	K.12
KWN-M6/16 45	1496870000	K.14
KWN-M6/16 90	1497090000	K.12
KWN-M6/2,5 90	1495280000	K.12

Type	Order No.	Page
KWN-M6/25 45	1496180000	K.14
KWN-M6/25 90	14	

Type	Order No.	Page
LIS 2,5M5 V	9200380000	J.18
LIS 2,5M6 V	9200390000	J.18
LIS 6M10 V	9200450000	J.18
LIS 6M4 V	9200410000	J.18
LIS 6M5 V	9200420000	J.18
LIS 6M6 V	9200430000	J.18
LIS 6M8 V	9200440000	J.18
LSP 4B	9205060000	G.10
LSP 4L	9205050000	G.10

## M

MASTER CHECK	9918880000	G.9
Master Check ZMM	9201260000	G.9
M-D-STRIPAX	9001280000	C.6
M-D-STRIPAX +6 MEHA	9003550000	C.6
M-D-STRIPAX AWG 18	9003740000	C.6
M-D-STRIPAX AWG 20-22	9003730000	C.6
M-D-STRIPAX AWG 24	9003720000	C.6
M-D-STRIPAX AWG 26-28	9003710000	C.6
M-D-STRIPAX AWG 30-32	9003700000	C.6
M-D-STRIPAX LWL	9003750000	D.54
MEHA KP BL M-D-SPX	9003630000	C.6
MEHA KP GE M-D-SPX	9003600000	C.6
MEHA KP GN M-D-SPX	9003620000	C.6
MEHA KP RT M-D-SPX	9003610000	C.6
MEHA KP SW M-D-SPX	9003640000	C.6
MEHA KP WS M-D-SPX	9006970000	C.6
MESSEREINSAZG CST VARIO	9005730000	C.15
MESSERHALTER CST VARIO	9005740000	C.15
MG KIT CA 600	9427460000	G.14
MTR 110	9018020000	D.36
MTR 110	9018020000	K.6
MTR 110	9018020000	K.7
MTR 160	9017250000	D.39
MTR 300	9021390000	D.39
MTR 35	9017500000	D.33
MTR 35	9017500000	K.6
MTR 35	9017500000	K.7
MULTI CHECK	9918920000	G.7
Multi Check 2MM	9201570000	G.7
MULTIMETER 1037	9423580000	G.15
MULTIMETER 125S	9425830000	G.13
MULTIMETER C 2606	9427370000	G.15
multi-stripax 0.25-1.5S	9204540000	C.10
multi-stripax 0.75-4°SL	9203610000	C.10
multi-stripax 1.5-6.0S	9204560000	C.10
multi-stripax 16 SL	9202220000	C.10
multi-stripax 6-16	9202210000	C.10
multi-stripax ASI	9202250000	C.10
multi-stripax AWG	9202230000	C.10
multi-stripax GWK LW	9205760000	C.10
multi-stripax IE-POF	1208880000	C.10
multi-stripax PV	1190490000	C.10

## P

PB LWL/POF	9020400000	D.54
POWERSTRIPPER 16,0	9028480000	L.6
POWERSTRIPPER 6,0	9028510000	L.6
Powerstripper AM 12	1534740000	L.8
POWERSTRIPPER ao 16-20	9027290000	I.7
POWERSTRIPPER ao 2,5-20	9027270000	I.7
Pro Case Insta	9203160000	H.4
Pro Case leer	9202470000	H.4
Pro Case leer	9202470000	H.4
Pro Case Premium	9202460000	H.4
PRSPSU	1332420000	G.6
PRSPSU	1332420000	G.6
PRSPSU	1332420000	G.7
PRSPSU	1332420000	G.8
PRSPSU	1332420000	G.8
PRSPSU	1332420000	G.9
PRSPSU	1332420000	G.9
PS LWL/POF	9020390000	D.54
PS_ZQV	1121740000	G.16
PS_ZQV_SET	1116710000	G.16
PUNCH DOWN TOOL PDT	9013970000	D.51
PV SET WM4	1257780000	H.11
PZ 1.5	9005990000	D.7
PZ 1.5	9005990000	D.4
PZ 1.5	9005990000	D.4
PZ 1.5	9005990000	J.3
PZ 1.5 ZERT	9005990000	J.3
PZ 1.5 ZERT	9017310000	D.7
PZ 10 HEX	1445070000	D.10
PZ 10 HEX ZERT	1989320000	D.10
PZ 10 SDR	1445080000	D.10
PZ 10 SDR ZERT	1989310000	D.10
PZ 16	9012600000	D.11
PZ 16	9012600000	D.4
PZ 16	9012600000	J.3
PZ 16 ZERT	9017340000	D.11
PZ 3	0567300000	D.7
PZ 3	0567300000	D.4
PZ 3	0567300000	D.4
PZ 3	0567300000	J.3
PZ 3	0567300000	J.3
PZ 3 ZERT	9017360000	D.7
PZ 4	9012500000	D.8

Type	Order No.	Page
PZ 4	9012500000	D.4
PZ 4	9012500000	D.4
PZ 4	9012500000	J.3
PZ 4	9012500000	J.3
PZ 4 ZERT	9017300000	D.8
PZ 50	9006450000	D.12
PZ 50	9006450000	D.4
PZ 50	9006450000	J.3
PZ 50 ZERT	9017400000	D.12
PZ 6 Roto	9014350000	D.9
PZ 6 Roto	9014350000	D.4
PZ 6 Roto	9014350000	D.4
PZ 6 Roto	9014350000	J.3
PZ 6 Roto	9014350000	J.3
PZ 6 ROTD L	1444050000	D.9
PZ 6 ROTD L ZERT	1527230000	D.9
PZ 6 ROTD ZERT	9017440000	D.9
PZ 6/5	9011460000	D.8
PZ 6/5	9011460000	D.4
PZ 6/5	9011460000	D.4
PZ 6/5	9011460000	J.3
PZ 6/5	9011460000	J.3
PZ 6/5 ZERT	9017900000	D.8
PZ PK 10/120	1500480000	D.32
PZ PK 6/70	1500470000	D.31
PZ RK 10/120	1500450000	D.32
PZ RK 6/70	1500440000	D.31
PZ ZH 16	9013600000	D.11
PZ ZH 16	9013600000	D.4
PZ ZH 16	9013600000	J.3
PZ ZH 16 ZERT	9013610000	D.11

## R

Removal Tool AFK	1866760000	D.52
Removal Tool CM 20	1866740000	D.52
Removal Tool CM 3	1866710000	D.52
Removal Tool CM 5	1866720000	D.52
REMOVAL TOOL HD	1866730000	D.52
Removal Tool HE	1866750000	D.52
RUNDPRESSEINS 120SM150SE	9016380000	D.40
RUNDPRESSEINS 150SM185SE	9016390000	D.40
RUNDPRESSEINS 185SM240SE	9016440000	D.40
RUNDPRESSEINS 25SM35SE	9016260000	D.40
RUNDPRESSEINS 35SM50SE	9016270000	D.40
RUNDPRESSEINS 60SM70SE	9016280000	D.40
RUNDPRESSEINS 70SM95SE	9016290000	D.40
RUNDPRESSEINS 95SM120SE	9016370000	D.40
RZ 160	9046360000	E.6

## S

SCHA CST	9032060000	C.14
SCHRAUBENDREHER CST	9005720000	C.14
SCHRAUBENDREHER CST	9005720000	C.15
SCISSOR 1 K	9918690000	B.16
SCISSOR 2 K	9918230000	B.17
SCISSORS KEVLAR	1208910000	B.17
Screwty-M12	1900000000	F.15
Screwty-M12 F	1900020000	F.15
Screwty M12 KO a. SD	1900100000	F.15
Screwty M12 KO o. SD	1900120000	F.15
Screwty M23	1998156000	F.15
Screwty-M8	1900010000	F.15
Screwty-M8 F	1900030000	F.15
Screwty M8 KO a. SD	1900110000	F.15
Screwty M8F KO o. SD	1900130000	F.15
Screwty Set	1910000000	F.15
Screwty Set -DM	1920000000	F.15
Screwty-M12-FDM	1900021000	F.15
Screwty-M12-DM	1900001000	F.15
Screwty-M8-FDM	1900031000	F.15
Screwty-M8-DM	1900011000	F.15
SD Set S2.0-5.5	9205560000	F.24
SD Set S2.5-5.5/PH1/2	9009740000	F.24
SD TH10	9009180000	F.23
SD TH15	9009170000	F.23
SD TH20	9009160000	F.23
SD TO 0,6X3,0	1323880000	F.24
SDI Set S2.0-5.5	9205550000	F.22
SDI Set S2.5-5.5/PH1/2	9009730000	F.22
SDI Set S2.5-5.5/PZ1/2	1128540000	F.22
SDI SL S3.5-6.5/PH1/2	1274750000	F.19
SDI SL/PH 1	1318330000	F.21
SDI SL/PH 2	1318340000	F.21
SDIK PH0	9008560000	F.21
SDIK PH1	9008570000	F.21
SDIK PH1 SL	1274710000	F.19
SDIK PH2	9008580000	F.21
SDIK PH2 SL	1274720000	F.19
SDIK PH3	9008590000	F.21
SDIK PZ1	9008900000	F.21
SDIK PZ1 SL	1274730000	F.19
SDIK PZ2	9008890000	F.21
SDIK PZ2 SL	1274740000	F.19
SDIS 0.4X2.0X60	9205690000	F.21
SDIS 0.4X2.5X75	9008370000	F.21
SDIS 0.5X3.0X100	9008380000	F.21
SDIS 0.6X3.5X100	9008390000	F.21

Type	Order No.	Page
SDIS 0.8X4.0X100	9008400000	F.21
SDIS 1.0X4.5X125	9008910000	F.21
SDIS 1.0X4.5X175	9205700000	F.21
SDIS 1.0X5.5X125	9008410000	F.21
SDIS 1.0X5.5X175	9205710000	F.21
SDIS 1.2X6.5X150	9008420000	F.21
SDIS 1.6X8.0X175	9008430000	F.21
SDIS SL 0.6X3.5X100	1274660000	F.19
SDIS SL 0.8X4.0X100	1274670000	F.19
SDIS SL 1.0X5.5X125	1274680000	F.19
SDIS SL 1.2X6.5X150	1274690000	F.19
SDIZ 0.8X5.5 150/248	9008640000	F.21
SDIZ 0.6X3.5X100	9008450000	F.21
SDIZ 0.8X4.0X100	9008460000	F.21
SDK PH0	9008470000	F.23
SDK PH1	9008480000	F.23
SDK PH2	9008490000	F.23
SDK PH3	9008500000	F.23
SDK PZ1	9008530000	F.23
SDK PZ2	9008540000	F.23
SDK PZ3	9008550000	F.23
SDQ T15	1318390000	F.28
SDQ T20	1318400000	F.28
SDQ T40	1318410000	F.28
SDS 0.4X2.0X60	9037160000	F.23
SDS 0.4X2.5X75	9009030000	F.23
SDS 0.5X3.0X80	9008320000	F.23
SDS 0.6X3.5X100	9008330000	F.23
SDS 0.6X3.5X200	9010110000	F.23
SDS 0.8X4.0X100	9008340000	F.23
SDS 0.8X4.5X125	9009020000	F.23
SDS 1.0X5.5X150	9008350000	F.23
SDS 1.2X6.5X150	9009010000	F.23
SE HD 140	9046310000	E.4
SE HD 160	9046320000	E.4
SE HD 180	9046330000	E.4
SE TOP	9046340000	E.4
SEE ESD 120	9205130000	E.8
SEE ESD 125	9204750000	E.8
SK 10,0x125	9009070000	F.23
SK WSDS-1.5-10,0	9008850000	F.25
SKAI TASCHKE	9201520000	G.6
SKAI TASCHKE	9201520000	G.6
SKAI TASCHKE	9201520000	G.7
SKAI TASCHKE	9201520000	G.8
SKAI TASCHKE	9201520000	G.8
SKAI TASCHKE	9201520000	G.9
SKAI TASCHKE	9201520000	G.11
SKAI TASCHKE	9201520000	G.11
SKAI TASCHKE	9201520000	G.16
SKS 2.0-8.0	9008860000	F.25
SKS 2.0-8.0 MR	9008870000	F.25
SLICER 1K	9918160000	B.16
SLICER 2K	9041600000	B.16
SLICER NO 16	9918070000	C.17
SLICER NO 27	9918080000	C.17
STEMPEL 10-70QMM	9022990000	D.40
STEMPEL 95-150QMM	9023110000	D.40
STRIPAX	9005000000	C.4
STRIPAX 16	9005610000	C.4
STRIPAX PLUS 2.5	9020000000	D.6
STRIPAX PLUS 2.5	9020000000	D.4
STRIPAX PLUS 2.5	9020000000	J.3
STRIPAX PLUS 2.5 ZERT	9011980000	D.6
STRIPAX ULTIMATE	1468880000	C.5
STRIPAX ULTIMATE XL	1512780000	C.5
STRIPAX ZERT	9017330000	C.4
STRIPPER COAX	9918030000	C.18
STRIPPER PC	9918060000	C.18
Stripper round	9918040000	C.16
STRIPPER ROUND TOP	9918050000	C.16
SUPER CUT	9205150000	E.9
SVSE ESD 130	9205140000	E.8
SWIFTY	9006020000	F.17
SYSTEM 11+1	9009750000	F.26
SZE ESD 130	9204770000	E.8

## T

TB 110	9201330000	G.18
TB 130	9201390000	G.18
TEMPHASER	9427300000	G.13
TH-S 9-40	9008880000	F.25
TOOL SET IE-POF	1208930000	H.11
TOP CASE	1345330000	H.5
TOP CASE	1345330000	H.5
TOP CASE INSTA	1345310000	H.5
TOP CASE PREMIUM	1345320000	H.5
TRAGEKASTEN MTR 110	9018040000	D.36
TRAGEKASTEN MTR 300	9021420000	D.39
TRAGEKASTEN MTR 35	9017840000	D.33
TRAGETASCHE MTR 160	9017270000	D.39
TSD 35	1318510000	B.12
TSLD 5	9918700000	B.11
TSLD C	1270310000	B.11
TT 1064 RS	9008190000	D.29
TT 164 RS	9008190000	D.5
TT 8 RS MP 8	9202800000	D.28
TT 8 RS MP 8	9202800000	D.5

Type	Order No.	Page
TT 864 RS	9008120000	D.29
TT 864 RS	9008120000	D.5

## U

UBH 1/4 E6.3	9009520000	F.9
UBH SWH 1/4 EC 6.3	9205680000	F.9

## V

VEI/1,5-2,5	1491580000	K.30
VEI/10	1491610000	K.30</

Type	Order No.	Page
VSTN/25	1494730000	K.15
VSTN/35	1493060000	K.25
VSTN/35	1494740000	K.15
VSTN/4	1497370000	K.15
VSTN/4-6	1493020000	K.25
VSTN/50	1493070000	K.25
VSTN/50	1494750000	K.15
VSTN/6	1494720000	K.15
VSTN/70	1493080000	K.25
VSTN/70	1494760000	K.15
VSTN/95	1493090000	K.25
VSTN/95	1494770000	K.15
VSTN-M0,5/0,75	1497330000	K.15
VSTN-M1/1,5	1497340000	K.15
VSTV/0,5-1,0	1491770000	K.32
VSTV/1,5-2,5	1491780000	K.32

## W

WAW 1 NEUTRAL	9004500000	B.9
WAW 2	9004510000	B.9
WFSKHV/0,5-1,05	1491960000	K.33
WFSKHV/1,5-2,5	1491970000	K.33
WK 1/4 C6,3 E6,3	9202510000	F.11
WK IK PH0	9918460000	F.12
WK IK PH1	9918470000	F.12
WK IK PH2	9918480000	F.12
WK IK PZ0	9918490000	F.12
WK IK PZ1	9918500000	F.12
WK IK PZ2	9918510000	F.12
WK IK SL/PH1	1318130000	F.12
WK IK SL/PH2	1318140000	F.12
WK K PH0	9918570000	F.11
WK K PH1	9918580000	F.11
WK K PH2	9918590000	F.11
WK K PZ0	9918600000	F.11
WK K PZ1	9918610000	F.11
WK K PZ2	9918620000	F.11
WK S 0,4x2,5	9918520000	F.11
WK S 0,5x3,0	9918530000	F.11
WK S 0,6x3,5	9918540000	F.11
WK S 0,8x4,0	9918550000	F.11
WK S 1,0x5,5	9918560000	F.11
WK SI 0,4x2,5	9918410000	F.12
WK SI 0,5x3,0	9918420000	F.12
WK SI 0,6x3,5	9918430000	F.12
WK SI 0,8x4,0	9918440000	F.12
WK SI 1,0x5,5	9918450000	F.12
WK-1/4(Screwty)	1862200000	F.15
WSM TOOL AUTOMATIK	1774470000	D.55
WSM TOOL MANUELL	1774480000	D.56

## Z

ZH-BOX 0,5-2,50MM	9025390000	J.16
ZUB MULTI 1037	9205460000	G.15
ZUB MULTI 1037	9205460000	G.16
ZUB MULTIMETER	9205270000	G.13
ZUB MULTIMETER	9205270000	G.15
ZUB MULTIMETER	9205270000	G.16
ZUB SLICER NO16-35	9201430000	C.17
ZUB SLICER NO16-35	9201430000	C.17
ZUB TEMPHASER	9205260000	G.13
ZUB TEMPHASER	9205260000	G.14
ZUB TEMPHASER	9205260000	G.16

Order No.	Type	Page
-----------	------	------

## 012000000

0124300000	H16,0/15	J.15
0124400000	H25,0/15	J.15
0124700000	H6,0/15	J.15
0124800000	H10,0/15	J.15

## 018000000

0186100000	H2,5/12	J.15
0186500000	H1,5/10	J.15

## 019000000

0191900000	H6,0/12	J.15
------------	---------	------

## 023000000

0235000000	IS 8 DIN 6911	F.28
------------	---------------	------

## 024000000

0244100000	H4,0/12	J.15
------------	---------	------

## 028000000

0282600000	H0,5/6	J.15
0282700000	H0,75/6	J.15
0282800000	H1,0/10	J.15
0282900000	H10,0/12	J.15

## 031000000

0317000000	H25,0/30 BR	J.4
0317100000	H25,0/36 BR	J.4
0317200000	H35,0/30 BE	J.4
0317300000	H35,0/39 BE	J.4

## 036000000

0368900000	H35,0/18	J.15
------------	----------	------

## 037000000

0372600000	H1,0/6	J.15
0372700000	H1,5/7	J.15
0373000000	H2,5/7	J.15
0373100000	H4,0/9	J.15
0375200000	H16,0/18	J.15
0375300000	H25,0/18	J.15
0379300000	H10,0/18	J.15

## 040000000

0407900000	IS 6 DIN 6911	F.28
0409500000	H0,5/12 OR	J.4
0409600000	H0,75/12 W	J.4
0409700000	H1,0/12 GE	J.4

## 044000000

0444200000	H50/36 OLIV	J.4
------------	-------------	-----

## 046000000

0462900000	H0,75/14 W	J.4
0463000000	H1,0/14 GE	J.4
0463100000	H1,5/14 R	J.4

## 048000000

0485100000	IS 4 DIN 6911	F.28
------------	---------------	------

## 049000000

0492500000	H16,0/12	J.15
------------	----------	------

## 053000000

0533500000	H6,0/20 SW	J.4
0534200000	H10,0/22 EB	J.4

## 054000000

0542500000	H0,75/10	J.15
------------	----------	------

## 056000000

0565600000	H1,5/24 R	J.4
0565700000	H6,0/26 SW	J.4
0565800000	H10,0/28 EB	J.4
0565900000	H16,0/22 GN	J.4
0566000000	H16,0/28 GN	J.4
0567300000	PZ 3	D.7
0567300000	PZ 3	D.7
0567300000	PZ 3	D.4
0567300000	PZ 3	J.3
0567300000	PZ 3	J.3

Order No.	Type	Page
-----------	------	------

## 063000000

0635100000	H1,5/16 R	J.4
------------	-----------	-----

## 069000000

0690700000	H0,5/14 OR	J.4
------------	------------	-----

## 104000000

1044080000	HÜLSE REMOVAL TOOL CM 3	D.53
1044090000	HÜLSE REMOVAL TOOL CM 5	D.53
1044100000	HÜLSE REMOVAL TOOL HD	D.53

## 107000000

1076980000	H0,5/18 OR	J.4
1076990000	H0,5/18D W	J.6
1077010000	CTF 63 ZERT	D.16

## 111000000

1116710000	PS_ZOV_SET	G.16
1119030000	ERME 10° SPX 4	C.4
1119040000	ERME 16° SPX 4	C.4

## 112000000

1121740000	PS_ZOV	G.16
1128540000	SDI Set S2.5-5.5/P21/2	F.22

## 113000000

1135240000	IE-KOK-V14	B.15
1137530000	VKSW	B.10
1139070000	H0,34/14 ZH TK	J.10

## 115000000

1157820000	KT 14	B.5
1157830000	KT 22	B.5

## 119000000

1190490000	multi-stripax PV	C.10
------------	------------------	------

## 120000000

1204280000	AIE MULTI-STRIPAX PV	C.11
1208870000	HTX-IE-POF	D.23
1208880000	multi-stripax IE-POF	C.10
1208910000	SCISSORS KEVLAR	B.17
1208930000	TOOL SET IE-POF	H.11

## 121000000

1212770000	AIE MULTI-STRIPAX POF	C.11
1216230000	HBT 6,0 - 4,6 GE	K.35

## 122000000

1222870000	CTF PV WM4	D.24
------------	------------	------

## 123000000

1233330000	HBT 2,5 - 4,6 BL	K.35
1233340000	HBT 1,5 - 4,6 RT	K.35

## 125000000

1251270000	ERME VKSW	B.10
1257780000	PV SET WM4	H.11

## 127000000

1270310000	TSLD C	B.11
1270320000	CTX CM 3.6 ZERT	D.20
1274660000	SDIS SL 0.6X3.5X100	F.19
1274670000	SDIS SL 0.8X4.0X100	F.19
1274680000	SDIS SL 1.0X5.5X125	F.19
1274690000	SDIS SL 1.2X6.5X150	F.19
1274710000	SDIK PH1 SL	F.19
1274720000	SDIK PH2 SL	F.19
1274730000	SDIK PZ1 SL	F.19
1274740000	SDIK PZ2 SL	F.19
1274750000	SDI SL S3.5-6.5/PH1/2	F.19
1279330000	COMBI CHECK PRO	G.8
1279550000	COMBI CHECK PRO 2MM	G.8

## 129000000

1292870000	CTN 25 D5 ZERT	D.19
1292880000	CTI 6 G ZERT	D.17
1296000000	KABELBINDERZANGE RT-1	D.55

## 130000000

1309580000	KOF CARRYLITE 80	H.14
------------	------------------	------

Order No.	Type	Page
-----------	------	------

## 131000000

1312440000	HBT 1,5 - 3,0 RT	K.35
1312450000	HBT 2,5 - 3,0 BL	K.35
1312470000	HBT 6,0 - 3,0 GE	K.35
1318130000	WK IK SL/PH1	F.12
1318140000	WK IK SL/PH2	F.12
1318330000	SDI SL/PH 1	F.21
1318340000	SDI SL/PH 2	F.21
1318350000	BIT E6,3 T15	F.8
1318370000	BIT E6,3 T20	F.8
1318380000	BIT E6,3 T40	F.8
1318390000	SDQ T15	F.28
1318400000	SDQ T20	F.28
1318410000	SDQ T40	F.28
1318510000	TSD 35	B.12

## 132000000

1323880000	SD TO 0,6X3,0	F.24
------------	---------------	------

## 133000000

1332420000	PRSPSU	G.6
1332420000	PRSPSU	G.6
1332420000	PRSPSU	G.7
1332420000	PRSPSU	G.8
1332420000	PRSPSU	G.8
1332420000	PRSPSU	G.9
1333100000	H2,5/14S BL	J.14

## 134000000

1345310000	TOP CASE INSTA	H.5
1345320000	TOP CASE PREMIUM	H.5
1345330000	TOP CASE	H.5
1345330000	TOP CASE	H.5

## 144000000

1444050000	PZ 6 ROTO L	D.9
1445070000	PZ 10 HEX	D.10
1445080000	PZ 10 SQR	D.10

## 146000000

1468880000	STRIPAX ULTIMATE	C.5
------------	------------------	-----

## 147000000

1471390000	ERME SPX UL	C.5
1477030000	CRIMPFIX RS	I.9
1479110000	AKKU DMS PRO	F.6
1479120000	DMS PRO	F.6

## 149000000

1491260000	KQIG-M6/2,5	K.28
1491270000	KQIG-M4/6	K.28
1491280000	KQIG-M5/6	K.28
1491290000	KQIG-M6/6	K.28
1491310000	KQIG-M8/6	K.28
1491320000	KQIG-M10/6	K.28
1491330000	KQIG-M5/10	K.28
1491340000	KQIG-M6/10	K.28
1491350000	KQIG-M6/16	K.28
1491360000	KQIG-M8/16	K.28
1491370000	KS/I,0-1,0,5	K.29
1491410000	KS/I,1,5-2,5	K.29
1491420000	KS/I,4,0-6,0	K.29
1491430000	KS/I,10	K.29
1491430000	KS/I,10	K.29
1491440000	KS/I,16	K.29
1491440000	KS/I,16	K.29
1491450000	VPL/0,1-0,5	K.30
1491460000	VPL/0,5-1,0	K.30
1491470000	VPL/1,5-2,5	K.30
1491480000	VPL/4,0-6,0	K.30
1491490000	VSRI/0,1-0,5	K.29
1491510000	VSRI/0,5-1,0	K.29
1491520000	VSRI/1,5-2,5	K.29
1491530000	VSRI/4,0-6,0	K.29
1491540000	VST/0,1-0,5	K.29
1491550000	VST/0,5-1,0	K.29
1491560000	VST/1,5-2,5	K.29
1491570000	VST/4,0-2,5	K.29
1491580000	VEI/1,5-2,5	K.30
1491590000	VEI/4-6	K.30
1491610000	VEI/10	K.30
1491640000	VFSKH/0,5-1,0/285	K.31
1491650000	VFSKH/0,5-1,0/288	K.31
1491660000	VFSKH/0,5-1,0/485	K.31
1491670000	VFSKH/0,5-1,0/488	K.31
1491680000	VFSKH/0,5-1,0/638	K.31
1491690000	VFSKH/1,5-2,5/485	K.31
1491710000	VFSKH/1,5-2,5/488	K.31
1491720000	VFSKH/1,5-2,5/638	K.31
1491730000	VFSKH/1,5-2,5/285	K.31
1491740000	VFSKH/1,5-2,5/288	K.31

Order No.	Type	Page
-----------	------	------

1491750000	VFSKH/4,0-6,0/638	K.31
1491760000	VFSKH/4,0-6,0/9512	K.31
1491770000	VSTV/0,5-1,0	K.32
1491780000	VSTV/1,5-2,5	



Order No.	Type	Page	Order No.	Type	Page	Order No.	Type	Page	Order No.	Type	Page
1492840000	KSN/95	K.24	1493910000	KQN-M8/2,5	K.21	1495130000	KRN-M4/4	K.9	1496240000	KWN-M10/35 45	K.14
1492850000	VPLN/0,1-0,5	K.25	1493930000	KQN-M10/2,5	K.21	1495140000	KRN-M5/4	K.9	1496250000	KWN-M12/35 45	K.14
1492860000	VPLN/0,5-1,0	K.25	1493940000	KQN-M12/2,5	K.21	1495150000	KRN-M6/4	K.9	1496270000	KWN-M6/50 45	K.14
1492870000	VPLN/1,5-2,5	K.25	1493950000	KQN-M4/6	K.21	1495170000	KRN-M8/4	K.9	1496280000	KWN-M8/50 45	K.14
1492880000	VPLN/4-6,0	K.25	1493960000	KQN-M5/6	K.21	1495180000	KWN-M3/0,75 90	K.12	1496290000	KWN-M10/50 45	K.14
1492890000	VPLN/10	K.25	1493970000	KQN-M6/6	K.21	1495190000	KWN-M4/0,75 90	K.12	1496300000	KWN-M12/50 45	K.14
1492900000	VPLN/16	K.25	1493980000	KQN-M8/6	K.21	1495200000	KWN-M5/0,75 90	K.12	1496310000	KWN-M8/70 45	K.14
1492910000	VPLN/25	K.25	1493990000	KQN-M10/6	K.21	1495210000	KWN-M3/1,5 90	K.12	1496320000	KWN-M10/70 45	K.14
1492920000	VPLN/35	K.25	1494000000	KQN-M12/6	K.21	1495220000	KWN-M4/1,5 90	K.12	1496330000	KWN-M12/70 45	K.14
1492930000	VPLN/50	K.25	1494010000	KQN-M4/10	K.22	1495230000	KWN-M5/1,5 90	K.12	1496340000	KWN-M8/95 45	K.14
1492940000	VPLN/70	K.25	1494020000	KQN-M5/10	K.22	1495240000	KWN-M6/1,5 90	K.12	1496350000	KWN-M10/95 45	K.14
1492950000	VPLN/95	K.25	1494030000	KQN-M6/10	K.22	1495250000	KWN-M4/2,5 90	K.12	1496370000	KWN-M12/95 45	K.14
1492960000	VPLN/120	K.25	1494040000	KQN-M8/10	K.22	1495270000	KWN-M5/2,5 90	K.12	1496380000	KWN-M16/95 45	K.14
1492970000	VPLN/150	K.25	1494050000	KQN-M10/10	K.22	1495280000	KWN-M6/2,5 90	K.12	1496390000	KWN-M8/120 45	K.14
1492980000	VSTN/0,1-0,5	K.25	1494060000	KQN-M12/10	K.22	1495290000	KWN-M8/2,5 90	K.12	1496400000	KWN-M10/120 45	K.14
1492990000	VSTN/0,5-10	K.25	1494070000	KQN-M5/16	K.22	1495300000	KWN-M4/4 90	K.12	1496410000	KWN-M12/120 45	K.14
1493010000	VSTN/1,5-5,5	K.25	1494080000	KQN-M6/16	K.22	1495310000	KWN-M5/4 90	K.12	1496420000	KWN-M16/120 45	K.14
1493020000	VSTN/4-6	K.25	1494090000	KQN-M8/16	K.22	1495320000	KWN-M6/4 90	K.12	1496430000	KWN-M8/150 45	K.14
1493030000	VSTN/10	K.25	1494100000	KQN-M10/16	K.22	1495330000	KWN-M8/4 90	K.12	1496440000	KWN-M10/150 45	K.14
1493040000	VSTN/16	K.25	1494110000	KQN-M12/16	K.22	1495340000	KWN-M10/185 45	K.14	1496450000	KWN-M16/150 45	K.14
1493050000	VSTN/25	K.25	1494120000	KQN-M5/25	K.22	1495350000	KWN-M12/185 45	K.14	1496470000	KWN-M16/150 45	K.14
1493060000	VSTN/35	K.25	1494130000	KQN-M6/25	K.22	1495370000	KWN-M16/185 45	K.14	1496480000	KWN-M20/150 45	K.14
1493070000	VSTN/50	K.25	1494140000	KQN-M8/25	K.22	1495380000	KWN-M20/185 45	K.14	1496490000	KRN-M6/25	K.9
1493080000	VSTN/70	K.25	1494150000	KQN-M10/25	K.22	1495400000	KWN-M12/240 45	K.14	1496500000	KRN-M8/25	K.9
1493090000	VSTN/95	K.25	1494160000	KQN-M12/25	K.22	1495410000	KWN-M16/240 45	K.14	1496510000	KRN-M10/25	K.9
1493110000	VSTN/120	K.25	1494170000	KQN-M6/35	K.22	1495420000	KWN-M20/240 45	K.14	1496520000	KRN-M12/25	K.9
1493120000	VSTN/150	K.25	1494180000	KQN-M8/35	K.22	1495430000	KRN-M10/185	K.10	1496530000	KRN-M14/25	K.9
1493130000	KQN-M12/35	K.22	1494190000	KQN-M10/35	K.22	1495440000	KRN-M12/185	K.10	1496540000	KRN-M6/35	K.10
1493140000	KQN-M16/35	K.22	1494200000	KRN-M10/240 S	K.11	1495450000	KRN-M16/185	K.10	1496550000	KRN-M8/35	K.10
1493150000	KQN-M8/50	K.22	1494210000	KRN-M12/240 S	K.11	1495470000	KRN-M20/185	K.10	1496570000	KRN-M10/35	K.10
1493160000	KQN-M10/50	K.22	1494220000	KRN-M16/240 S	K.11	1495480000	KRN-M8/240	K.10	1496580000	KRN-M12/35	K.10
1493170000	KQN-M12/50	K.22	1494230000	KRN-M10/300 S	K.11	1495490000	KRN-M10/240	K.10	1496590000	KRN-M6/50	K.10
1493180000	KQN-M16/50	K.22	1494240000	KRN-M12/300 S	K.11	1495500000	KRN-M12/240	K.10	1496600000	KRN-M8/50	K.10
1493190000	KQN-M6/70	K.22	1494250000	KRN-M16/300 S	K.11	1495510000	KRN-M16/240	K.10	1496610000	KRN-M10/50	K.10
1493200000	KQN-M8/70	K.22	1494260000	KRN-M6/120 S	K.11	1495520000	KRN-M20/240	K.10	1496620000	KRN-M12/50	K.10
1493210000	KQN-M10/70	K.22	1494270000	KRN-M8/120 S	K.11	1495530000	KRN-M10/300	K.10	1496630000	KRN-M16/50	K.10
1493220000	KQN-M12/70	K.22	1494280000	KRN-M6/95 S	K.11	1495540000	KRN-M12/300	K.10	1496640000	KRN-M6/70	K.10
1493230000	KQN-M16/70	K.22	1494290000	KRN-M6/150 S	K.11	1495550000	KRN-M16/300	K.10	1496650000	KRN-M8/70	K.10
1493240000	KQN-M20/70	K.22	1494300000	KWN-M10/120 90	K.13	1495570000	KRN-M12/70	K.10	1496670000	KRN-M10/70	K.10
1493250000	KQN-M8/95	K.22	1494310000	KWN-M12/120 90	K.13	1495580000	KRN-M16/70	K.10	1496680000	KWN-M5/10 45	K.14
1493260000	KQN-M10/95	K.22	1494320000	KWN-M16/120 90	K.13	1495590000	KRN-M20/70	K.10	1496690000	KWN-M6/10 45	K.14
1493270000	KQN-M12/95	K.22	1494330000	KWN-M8/150 90	K.13	1495600000	KRN-M8/95	K.10	1496700000	KWN-M8/10 45	K.14
1493280000	KQN-M16/95	K.22	1494340000	KWN-M10/150 90	K.13	1495610000	KRN-M10/95	K.10	1496710000	KWN-M10/10 45	K.14
1493290000	KQN-M20/95	K.22	1494350000	KWN-M12/150 90	K.13	1495620000	KRN-M12/95	K.10	1496720000	KWN-M5/16 45	K.14
1493300000	KQN-M8/120	K.22	1494360000	KWN-M16/150 90	K.13	1495630000	KRN-M16/95	K.10	1496730000	KWN-M6/16 45	K.14
1493310000	KQN-M10/120	K.22	1494370000	KWN-M20/150 90	K.13	1495640000	KRN-M20/95	K.10	1496740000	KWN-M8/16 45	K.14
1493320000	KQN-M12/120	K.22	1494380000	KWN-M10/185 90	K.13	1495650000	KRN-M10/120	K.10	1496750000	KWN-M10/16 45	K.14
1493330000	KQN-M16/120	K.22	1494390000	KWN-M12/185 90	K.13	1495660000	KRN-M12/120	K.10	1496760000	KRN-M4/10	K.9
1493340000	KQN-M20/120	K.22	1494400000	KWN-M16/185 90	K.13	1495670000	KRN-M16/120	K.10	1496770000	KRN-M5/10	K.9
1493350000	KQN-M10/150	K.22	1494410000	KWN-M20/185 90	K.13	1495680000	KRN-M10/150	K.10	1496780000	KRN-M6/10	K.9
1493360000	KQN-M12/150	K.22	1494420000	KWN-M8/240 90	K.13	1495690000	KRN-M12/150	K.10	1496790000	KRN-M8/10	K.9
1493370000	KQN-M16/150	K.22	1494430000	KWN-M10/240 90	K.13	1495700000	KRN-M16/150	K.10	1496800000	KRN-M10/10	K.9
1493380000	KQN-M8/185	K.22	1494440000	KWN-M12/240 90	K.13	1495710000	KRN-M10/185	K.10	1496810000	KRN-M12/10	K.9
1493390000	KQN-M10/185	K.22	1494450000	KWN-M16/240 90	K.13	1495720000	KRN-M12/185	K.10	1496820000	KRN-M16/10	K.9
1493400000	KQN-M12/185	K.22	1494460000	KWN-M20/240 90	K.13	1495730000	KRN-M16/185	K.10	1496830000	KRN-M8/10 45	K.14
1493410000	KQN-M16/185	K.22	1494470000	KWN-M14/35 90	K.12	1495740000	KRN-M20/150	K.10	1496840000	KRN-M10/10 45	K.14
1493420000	KQN-M185	K.22	1494480000	KWN-M14/50 90	K.13	1495750000	KRN-M14/50	K.10	1496850000	KRN-M8/16	K.9
1493430000	KQN-M20/185	K.22	1494490000	KWN-M14/70 90	K.13	1495760000	KRN-M14/70	K.10	1496860000	KRN-M10/16	K.9
1493440000	KQN-M10/240	K.22	1494500000	KWN-M14/95 90	K.13	1495770000	KRN-M14/95	K.10	1496870000	KRN-M12/16	K.9
1493450000	KQN-M12/240	K.22	1494510000	KWN-M8/120 90	K.13	1495780000	KRN-M14/120	K.10	1496880000	KRN-M16/45	K.14
1493460000	KQN-M16/240	K.22	1494520000	KWN-M16/35 90	K.12	1495790000	KRN-M8/120	K.10	1496890000	KRN-M10/16 45	K.14
1493470000	KQN-M185	K.22	1494530000	KWN-M10/50 S	K.11	1495800000	KRN-M14/120	K.10	1496900000	KRN-M4/10	K.9
1493480000	KQN-M20/185	K.22	1494540000	KRN-M10/70 S	K.11	1495810000	KRN-M16/120	K.10	1496910000	KRN-M5/10	K.9
1493490000	KQN-M16/25	K.22	1494550000	KRN-M12/70 S	K.11	1495820000	KRN-M8/150	K.10	1496920000	KRN-M6/10	K.9
1493500000	KQN-M8/50	K.22	1494560000	KRN-M16/70 S	K.11	1495830000	KRN-M10/150	K.10	1496930000	KRN-M8/10	K.9
1493510000	KQN-M10/35	K.22	1494570000	KRN-M20/70 S	K.11	1495840000	KRN-M12/150	K.10	1496940000	KRN-M10/10	K.9
1493520000	KQN-M20/35	K.22	1494580000	KRN-M8/95 S	K.11	1495850000	KRN-M16/150	K.10	1496950000	KRN-M12/10	K.9
1493530000	KQN-M20/50	K.22	1494590000	KRN-M6/120 S	K.11	1495860000	KRN-M10/185	K.10	1496960000	KRN-M16/10	K.9
1493540000	KQNG-M3/1	K.23	1494600000	KRN-M4/150 S	K.11	1495870000	KRN-M12/185	K.10	1496970000	KRN-M8/16	K.9
1493550000	KQNG-M3,5/1	K.23	1494610000	KRN-M6/150 S	K.11	1495880000	KRN-M16/185	K.10	1496980000	KRN-M6/16	K.9
1493560000	KQNG-M4/S/1	K.23	1494620000	KRN-M8/50 S	K.11	1495890000	KRN-M10/25 90	K.12	1496990000	KRN-M8/16	K.9
1493570000	KQNG-M4/S/1	K.23	1494630000	KRN-M10/50 S	K.11	1495900000	KWN-M12/25 90	K.12	1497000000	KRN-M10/16	K.9
1493580000	KQNG-M5/1	K.23	1494640000	KRN-M12/50 S	K.11	1495910000	KWN-M16/25 90	K.12	1497010000	KRN-M12/16	K.9
1493590000	KQNG-M6/1	K.23	1494650000	KRN-M16/50 S	K.11	1495920000	KWN-M8/35 90	K.12	1497020000	KRN-M16/10 90	K.12
1493600000	KQNG-M3/2,5	K.23	1494660000	KRN-M20/50 S	K.11	1495930000	KWN-M6/25 90	K.12	1497030000	KRN-M5/10 90	K.12
1493610000	KQNG-M3,5/2,5	K.23	1494670000	KRN-M8/70 S	K.11	1495940000	KWN-M8/25 90	K.12	1497040000	KRN-M6/10 90	K.12
1493620000	KQNG-M4/S/2,5	K.23	1494680000	KRN-M10/70 S	K.11	1495950000	KWN-M10/25 90	K.12	1497050000	KRN-M8/10 90	K.12
1493630000	KQNG-M4/2,5	K.23	1494690000	KRN-M12/70 S	K.11	1495960000	KWN-M12/25 90	K.12	1497060000	KRN-M10/10 90	K.12
1493640000	KQNG-M5/2,5	K.23	1494700000	KRN-M16/70 S	K.11	1495970000	KWN-M16/25 90	K.12	1497070000	KRN-M12/10 90	K.12
1493650000	KQNG-M6/2,5	K.23	1494710000	KRN-M8/95 S	K.11	1495980000	KWN-M8/35 90	K.12	1497080000	KRN-M5/16 90	K.12
1493660000	KQNG-M4/6	K.23	1494720000	KRN-M10/95 S	K.11	1495990000	KWN-M6/35 90	K.12	1497090000	KRN-M6/16 90	K.12
1493670000	KQN-M2/0,5	K.21	1494730000	KRN-M12/95 S	K.11	1496000000	KWN-M8/25 90	K.12	1497100000	KRN-M8/16 90	K.12
1493680000	KQN-M3/										

Order No.	Type	Page
1497920000	KP-M5/-16	K.17
1497930000	KP-M6/-16	K.17
1497940000	KP-M8/-16	K.17
1497950000	KP-M10/-16	K.17
1497960000	KP-M12/-16	K.17
1497970000	KP-M6/-25	K.17
1497980000	KP-M8/-25	K.17
1497990000	KP-M10/-25	K.17
1498000000	KP-M12/-25	K.17
1498010000	KP-M16/-25	K.17
1498020000	KP-M6/-35	K.17
1498030000	KP-M8/-35	K.17
1498040000	KP-M10/-35	K.17
1498050000	KP-M12/-35	K.17
1498060000	KP-M16/-35	K.17
1498070000	KP-M8/-50	K.17
1498080000	KP-M10/-50	K.17
1498090000	KP-M12/-50	K.17
1498110000	KP-M16/-50	K.17
1498120000	KP-M20/-50	K.17
1498130000	KP-M8/-70	K.17
1498140000	KP-M10/-70	K.17
1498150000	KP-M12/-70	K.17
1498160000	KP-M16/-70	K.17
1498170000	KP-M20/-70	K.17
1498180000	KP-M8/-95	K.17
1498190000	KP-M10/-95	K.17
1498210000	KP-M12/-95	K.17
1498220000	KP-M16/-95	K.17
1498230000	KP-M20/-95	K.17
1498240000	KP-M10/-120	K.18
1498250000	KP-M12/-120	K.18
1498270000	KP-M16/-120	K.18
1498280000	KP-M20/-120	K.18
1498290000	KP-M8/-150	K.18
1498310000	KP-M10/-150	K.18
1498320000	KP-M12/-150	K.18
1498330000	KP-M16/-150	K.18
1498340000	KP-M20/-150	K.18
1498350000	KP-M10/-185	K.18
1498360000	KP-M12/-185	K.18
1498370000	KP-M16/-185	K.18
1498380000	KP-M20/-185	K.18
1498390000	KP-M10/-240	K.18
1498410000	KP-M12/-240	K.18
1498420000	KP-M16/-240	K.18
1498430000	KP-M20/-240	K.18
1498440000	KP-M10/-300	K.18
1498450000	KP-M12/-300	K.18
1498460000	KP-M16/-300	K.18
1498470000	KP-M20/-300	K.18
1498480000	KP-M8/-120	K.18
1498490000	KP-M14/-120	K.18
1498510000	KP-M6/-50	K.17
1498520000	KP-M14/95	K.17
1498530000	KP-M14/-240	K.18
1498540000	KP-M8/-185	K.18
1498550000	KP-M14/-300	K.18
1498560000	KP-M14/-70	K.17
1498570000	KP-M14/-150	K.17
1498580000	KP-M14/-185	K.18
1498590000	KP-M14/-185	K.18
1498610000	VPN-/6	K.19
1498620000	VPN-/10	K.19
1498630000	VPN-/16	K.19
1498640000	VPN-/25	K.19
1498650000	VPN-/35	K.19
1498660000	VPN-/50	K.19
1498670000	VPN-/70	K.19
1498680000	VPN-/95	K.19
1498690000	VPN-/120	K.19
1498710000	VPN-/150	K.19
1498720000	VPN-/185	K.19
1498730000	VPN-/240	K.19
1498740000	VPN-/300	K.19

## 1500000000

1500440000	PZ RK 6/70	D.31
1500450000	PZ RK 10/120	D.32
1500470000	PZ PK 6/70	D.31
1500480000	PZ PK 10/120	D.32
1500490000	ES MTR35 WM 6	D.34
1500500000	ES MTR35 WM 10	D.34
1500520000	ES MTR35 WM 16	D.34
1500530000	ES MTR35 WM 25	D.34
1500540000	ES MTR35 WM 35	D.34
1500550000	ES MTR35 WM 50	D.34
1500580000	ES MTR35 HEX 6	D.34
1500590000	ES MTR35 HEX 10	D.34
1500600000	ES MTR35 HEX 16	D.34
1500620000	ES MTR35 HEX 25	D.34
1500630000	ES MTR35 HEX 35	D.34
1500640000	ES MTR35 HEX 50	D.34
1500650000	ES MTR35 DIN 6	D.34
1500670000	ES MTR35 DIN 10	D.34
1500680000	ES MTR35 DIN 16	D.34
1500690000	ES MTR35 DIN 25	D.34
1500700000	ES MTR35 DIN 35	D.34

Order No.	Type	Page
1500720000	ES MTR35 ISO 10	D.34
1500730000	ES MTR35 ISO 16	D.34
1500740000	ES MTR35 ISO 25	D.34
1500750000	ES MTR35 AEH 6	D.34
1500770000	ES MTR35 AEH 10	D.34
1500780000	ES MTR35 AEH 16	D.34
1500790000	ES MTR35 AEH 25	D.34
1500800000	ES MTR35 AEH 35	D.34
1500820000	ES MTR35 AEH 50	D.34
1500830000	EPG 45	D.35
1500840000	AKKU EPG 45	D.35
1500840000	AKKU EPG 45	D.49
1500850000	ES MTR110 WM 6	D.37
1500870000	ES MTR110 WM 10/70	D.37
1500880000	ES MTR110 WM 25/50	D.37
1500890000	ES MTR110 WM 95	D.37
1500900000	ES MTR110 WM 120	D.37
1500920000	ES MTR110 WM 16/35	D.37
1500930000	ES MTR110 HEX 6	D.37
1500940000	ES MTR110 HEX 10/70	D.37
1500950000	ES MTR110 HEX 16/35	D.37
1500970000	ES MTR110 HEX 25/50	D.37
1500980000	ES MTR110 HEX 95	D.37
1500990000	ES MTR110 HEX 120	D.37
1501000000	ES MTR110 ISO 10	D.37
1501020000	ES MTR110 ISO 16	D.37
1501030000	ES MTR110 AEH 6	D.37
1501040000	ES MTR110 AEH 10	D.37
1501050000	ES MTR110 AEH 16	D.37
1501070000	ES MTR110 AEH 25	D.37
1501170000	ES MTR110 AEH 35	D.37
1501180000	ES MTR110 AEH 50	D.37
1501190000	ES MTR110 RUND 10	D.38
1501200000	ES MTR110 RUND 16	D.38
1501220000	ES MTR110 RUND 25/35	D.38
1501230000	ES MTR110 RUND 35/50	D.38
1501240000	ES MTR110 RUND 50/70	D.38
1501250000	ES MTR110 RUND 70/95	D.38
1501270000	ES MTR110 RUND 95/120	D.38
1501280000	ES MTR110 RUND 120/150	D.38
1501290000	ES MTR110 DIN 6	D.37
1501320000	ES MTR110 DIN 10	D.37
1501330000	ES MTR110 DIN 16	D.37
1501340000	ES MTR110 DIN 25	D.37
1501350000	ES MTR110 DIN 35	D.37
1501370000	ES MTR110 DIN 50	D.37
1501380000	ES MTR110 DIN 70	D.37
1501390000	APG 55	D.41
1501400000	HPG 55	D.42
1501420000	ES APG/HPG55 WM 6	D.43
1501430000	ES APG/HPG55 WM10/70	D.43
1501440000	ES APG/HPG55 WM 16/35	D.43
1501450000	ES APG/HPG55 WM 25/50	D.43
1501470000	ES APG/HPG55 WM 95	D.43
1501480000	ES APG/HPG55 WM 120	D.43
1501490000	ES APG/HPG55 WM 150	D.43
1501500000	ES APG/HPG55 WM 185	D.43
1501520000	ES APG/HPG55 WM 240	D.43
1501530000	ES APG/HPG55 HEX 6	D.43
1501540000	ES APG/HPG55 HEX 10/70	D.43
1501550000	ES APG/HPG55 HEX 16/35	D.43
1501570000	ES APG/HPG55 HEX 25/50	D.43
1501580000	ES APG/HPG55 HEX 95	D.43
1501590000	ES APG/HPG55 HEX 120	D.43
1501600000	ES APG/HPG55 HEX 150	D.43
1501620000	ES APG/HPG55 HEX 185	D.43
1501630000	ES APG/HPG55 DIN 6	D.43
1501640000	ES APG/HPG55 DIN 10	D.43
1501650000	ES APG/HPG55 DIN 16	D.43
1501670000	ES APG/HPG55 DIN 25	D.43
1501680000	ES APG/HPG55 DIN 35	D.43
1501690000	ES APG/HPG55 DIN 50	D.43
1501700000	ES APG/HPG55 DIN 70	D.43
1501720000	ES APG/HPG55 DIN 95	D.43
1501730000	ES APG/HPG55 DIN 120	D.43
1501740000	ES APG/HPG55 ISO 10	D.43
1501750000	ES APG/HPG55 ISO 16	D.43
1501770000	ES APG/HPG55 ISO 25	D.43
1501780000	ES APG/HPG55 ISO 35	D.43
1501790000	ES APG/HPG55 ISO 50	D.43
1501800000	ES APG/HPG80 DIN 185	D.46
1501820000	ES APG/HPG80 DIN 240	D.46
1501830000	ES APG/HPG80 ISO 10	D.46
1501840000	ES APG/HPG80 ISO 16	D.46
1501850000	ES APG/HPG80 RD 10	D.47
1501870000	ES APG/HPG80 RD 16	D.47
1501880000	ES APG/HPG80 RD 25/35	D.47
1501890000	ES APG/HPG80 RD 35/50	D.47
1501900000	ES APG/HPG80 RD 50/70	D.47
1501920000	ES APG/HPG80 RD 70/95	D.47
1501930000	ES APG/HPG80 RD 95/120	D.47
1501940000	ES APG/HPG80 RD 120/150	D.47
1501970000	ES APG/HPG80 RD 150/185	D.47
1501980000	ES APG/HPG80 RD 185/240	D.47
1501990000	ES APG/HPG80 RD 240/300	D.47
1502000000	ES APG/HPG80 AEH 10	D.47
1502020000	ES APG/HPG80 AEH 16	D.47
1502030000	ES APG/HPG80 AEH 25	D.47
1502040000	ES APG/HPG80 AEH35	D.47

Order No.	Type	Page
1502050000	ES APG/HPG80 AEH 50	D.47
1502070000	ES APG/HPG80 AEH 70	D.47
1502080000	ES APG/HPG80 AEH 95	D.47
1502090000	ES APG/HPG80 AEH 120	D.47
1502100000	ES APG/HPG80 AEH 150	D.47
1502120000	ES APG/HPG80 AEH 185	D.47
1502130000	ES APG/HPG80 AEH 240	D.47
1502140000	AKKU APG/AKT	D.41
1502140000	AKKU APG/AKT	D.44
1502140000	AKKU APG/AKT	D.49
1502170000	LADEGERAET APG/AKT	D.41
1502170000	LADEGERAET APG/AKT	D.44
1502170000	LADEGERAET APG/AKT	D.49
1502190000	AKT 50	D.48
1502250000	ES APG/HPG55 ISO 70	D.43
1502270000	ES APG/HPG55 AEH 6	D.43
1502280000	ES APG/HPG55 AEH 10	D.43
1502290000	ES APG/HPG55 AEH 16	D.43
1502300000	ES APG/HPG55 AEH 25	D.43
1502320000	ES APG/HPG55 AEH35	D.43
1502330000	ES APG/HPG55 AEH 50	D.43
1502340000	ES APG/HPG55 AEH 70	D.43
1502370000	ES APG/HPG55 AEH 95	D.43
1502380000	ES APG/HPG55 AEH 120	D.43
1502390000	APG 80	D.44
1502420000	HPG 80	D.45
1502430000	ES APG/HPG80 WM 6	D.46
1502440000	ES APG/HPG80 WM10	D.46
1502470000	ES APG/HPG80 WM 16	D.46
1502480000	ES APG/HPG80 WM 25	D.46
1502490000	ES APG/HPG80 WM 35	D.46
1502500000	ES APG/HPG80 WM 50	D.46
1502520000	ES APG/HPG80 WM 70	D.46
1502530000	ES APG/HPG80 WM 95	D.46
1502540000	ES APG/HPG80 WM 120	D.46
1502550000	ES APG/HPG80 WM 150	D.46
1502570000	ES APG/HPG80 WM 185	D.46
1502580000	ES APG/HPG80 WM 240	D.46
1502590000	ES APG/HPG80 WM 300	D.46
1502600000	ES APG/HPG80 HEX 6	D.46
1502620000	ES APG/HPG80 HEX 10	D.46
1502630000	ES APG/HPG80 HEX 16	D.46
1502640000	ES APG/HPG80 HEX 25	D.46
1502650000	ES APG/HPG80 HEX 35	D.46
1502670000	ES APG/HPG80 HEX 50	D.46
1502680000	ES APG/HPG80 HEX 70	D.46
1502690000	ES APG/HPG80 HEX 95	D.46
1502700000	ES APG/HPG80 HEX 120	D.46
1502720000	ES APG/HPG80 HEX 150	D.46
1502730000	ES APG/HPG80 HEX 185	D.46
1502740000	ES APG/HPG80 HEX 240	D.46
1502750000	ES APG/HPG80 HEX 300	D.46
1502780000	ES APG/HPG80 HEX 300AL	D.46
1502790000	ES APG/HPG80 DIN 120	D.46
1502800000	ES APG/HPG80 DIN 150	D.46
1502820000	ES APG/HPG80 DIN 6	D.46
1502830000	ES APG/HPG80 DIN 10	D.46
1502840000	ES APG/HPG80 DIN 16	D.46
1502850000	ES APG/HPG80 DIN 25	D.46
1502870000	ES APG/HPG80 DIN 35	D.46
1502880000	ES APG/HPG80 DIN 50	D.46
1502890000	ES APG/HPG80 DIN 70	D.46
1502900000	ES APG/HPG80 DIN 95	D.46
1508820000	APG 80 120V	D.44
1509370000	LADEGERAET EPG 45	D.35
1509380000	LADEGERAET EPG 45	D.49
1509380000	LADEGERAET EPG 45 120V	D.35
1509380000	LADEGERAET EPG 45 120V	D.49
1509390000	LADEGERAET APG/AKT 120 V	D.41
1509390000	LADEGERAET APG/AKT 120 V	D.44
1509390000	LADEGERAET APG/AKT 120 V	D.49

## 1510000000

1512780000	STRIPAX ULTIMATE XL	C.5
1512790000	ERME SPX UL XL	C.5

## 1520000000

1527230000	PZ 6 ROTO L ZERT	D.9
------------	------------------	-----

## 1530000000

1534740000	Powerstripper AM 12	I.8
------------	---------------------	-----

## 1770000000

Order No.	Type	Page
9004190000	H35,0/25	J.15
9004200000	H35,0/32	J.15
9004210000	H50,0/18	J.15
9004220000	H50,0/32	J.15
9004230000	H70,0/25	J.15
9004240000	H70,0/32	J.15
9004250000	H95,0/25	J.15
9004260000	H95,0/32	J.15
9004270000	H0,5/14 OR BD	J.5
9004280000	H0,5/14D W BD	J.6
9004280000	H0,5/14D W BD	J.8
9004290000	H0,75/14 W BD	J.6
9004300000	H0,75/14D GR BD	J.5
9004310000	H0,75/14T HBL BD	J.8
9004320000	H1,0/14 GE BD	J.5
9004330000	H1,0/14D R BD	J.6
9004330000	H1,0/14D R BD	J.8
9004340000	H1,5/14 R BD	J.5
9004350000	H1,5/14D SW BD	J.6
9004350000	H1,5/14D SW BD	J.8
9004360000	H2,5/14D BL BD	J.5
9004360000	H2,5/14D BL BD	J.6
9004370000	H2,5/14T GR BD	J.8
9004390000	H0,34/12 TK BD GSP	J.5
9004410000	H1,5/16 ZH R SV	J.10
9004420000	H1,5/16D ZH SW SV	J.11
9004420000	H1,5/16D ZH SW SV	J.12
9004430000	H2,5/19D ZH BL SV	J.10
9004430000	H2,5/19D ZH BL SV	J.11
9004440000	H0,5/14 ZH GR SV	J.10
9004500000	WAW 1 NEUTRAL	B.9
9004510000	WAW 2	B.9
9004530000	DW RSV 1.6	D.52
9004560000	H0,5/14S OR	J.14
9004590000	H0,5/14S W	J.14
9004710000	H10,0/26D R ZH SV	J.11
9004720000	H6,0/23D ZH GE SV	J.11
9004730000	H4/22D ZH GR SV	J.10
9004730000	H4/22D ZH GR SV	J.11
9004740000	H2,5/21D ZH BL SV	J.10
9004740000	H2,5/21D ZH BL SV	J.11
9004750000	H1,5/20D SW ZH SV	J.11
9004750000	H1,5/20D SW ZH SV	J.12
9004760000	H1,0/19D ZH R SV	J.11
9004760000	H1,0/19D ZH R SV	J.12
9004770000	H0,75/16D ZH GR SV	J.11
9004780000	H0,5/14D ZH W SV	J.11
9004810000	BLOCKBATTERIE 9V	G.13
9004810000	BLOCKBATTERIE 9V	G.13
9004810000	BLOCKBATTERIE 9V	G.14
9004810000	BLOCKBATTERIE 9V	G.15
9004810000	BLOCKBATTERIE 9V	G.15
9004900000	H0,75/16 ZH W SV	J.10
9004910000	H1,0/19 ZH GE SV	J.10
9004920000	H1,5/20 ZH R SV	J.10
9004930000	H6,0/23 ZH SW SV	J.10
9004940000	H10,0/24 ZH EB SV	J.10
9005000000	STRIPAX	C.4
9005140000	H0,75/16T ZH HBL SV	J.12
9005150000	H2,5/21 ZH GR SV	J.12
9005160000	H6,0/23T ZH GN SV	J.12
9005170000	H10,0/26T ZH BR SV	J.12
9005180000	H0,14/10 GR SV	J.4
9005610000	STRIPAX 16	C.4
9005700000	CST VARIO	C.15
9005720000	SCHRAUBENDREHER CST	C.14
9005720000	SCHRAUBENDREHER CST	C.15
9005730000	MESSEREINSATZ CST VARIO	C.15
9005740000	MESSERHALTER CST VARIO	C.15
9005800000	EINSTELLBLOCK CST	C.14
9005810000	H0,5/14 OR BD GSP	J.5
9005820000	H0,75/14 W BD GSP	J.5
9005830000	H1,0/14 GE BD GSP	J.5
9005840000	H1,5/14 R BD GSP	J.5
9005850000	H2,5/14D BL BD GSP	J.5
9005850000	H2,5/14D BL BD GSP	J.7
9005860000	H0,5/14D W BD GSP	J.7
9005860000	H0,5/14D W BD GSP	J.9
9005870000	H0,75/14D GR	J.7
9005880000	H1,0/14D R BD GSP	J.7
9005880000	H1,0/14D R BD GSP	J.9
9005890000	H1,5/14D SW BD GSP	J.7
9005890000	H1,5/14D SW BD GSP	J.9
9005900000	H0,75/14T BL BD GSP	J.9
9005910000	H2,5/14T GR BD GSP	J.9
9005990000	PZ 1.5	D.7
9005990000	PZ 1.5	D.4
9005990000	PZ 1.5	D.4
9005990000	PZ 1.5	D.4
9005990000	PZ 1.5	J.3
9005990000	PZ 1.5	J.3
9006020000	SWIFTY	F.17
9006120000	CTI 6	D.17
9006120000	CTI 6	D.5
9006120000	CTI 6	J.3
9006220000	CTN 25 D4	D.19
9006220000	CTN 25 D4	D.5
9006230000	CTN 25 D5	D.19
9006230000	CTN 25 D5	D.5
9006320000	CTX 500	D.26

Order No.	Type	Page
9006320000	CTX 500	D.5
9006370000	CTX 501	D.26
9006370000	CTX 501	D.5
9006380000	CTX 502	D.26
9006380000	CTX 502	D.5
9006450000	PZ 50	D.12
9006450000	PZ 50	D.4
9006450000	PZ 50	J.3
9006590000	H1,5/17,5X SW SV	J.13
9006630000	H1,5/19,5X SW SV	J.13
9006670000	H2,5/17,5X BL SV	J.13
9006710000	H2,5/21,5X BL SV	J.13
9006750000	H4,0/19,5X GR SV	J.13
9006790000	H6,0/23,0X GE SV	J.13
9006830000	H10,0/24,0X R SV	J.13
9006870000	H16,0/25,5X BL SV	J.13
9006970000	MEHA KP WS M-D-SPX	C.6
9007440000	DMS 3	F.7
9007450000	AKKU DMS 3	F.7
9007460000	LG DMS PRO/ DMS 3	F.6
9007460000	LG DMS PRO/ DMS 3	F.7
9008120000	TT 864 RS	D.29
9008120000	TT 864 RS	D.5
9008130000	ERSATZMESSERSATZ TT864	D.29
9008130000	ERSATZMESSERSATZ TT864	D.29
9008190000	TT 1064 RS	D.29
9008190000	TT 1064 RS	D.5
9008320000	SDS 0.5X3.0X80	F.23
9008330000	SDS 0.6X3.5X100	F.23
9008340000	SDS 0.8X4.0X100	F.23
9008350000	SDS 1.0X5.5X150	F.23
9008370000	SDIS 0.4X2.5X75	F.21
9008380000	SDIS 0.5X3.0X100	F.21
9008390000	SDIS 0.6X3.5X100	F.21
9008400000	SDIS 0.8X4.0X100	F.21
9008410000	SDIS 1.0X5.5X125	F.21
9008420000	SDIS 1.2X6.5X150	F.21
9008430000	SDIS 1.6X8.0X175	F.21
9008450000	SDIZ 0.6X3.5X100	F.21
9008460000	SDIZ 0.8X4.0X100	F.21
9008470000	SDK PH0	F.23
9008480000	SDK PH1	F.23
9008490000	SDK PH2	F.23
9008500000	SDK PH3	F.23
9008530000	SDK PZ1	F.23
9008540000	SDK PZ2	F.23
9008550000	SDK PZ3	F.23
9008560000	SDK PH0	F.21
9008570000	SDK PH1	F.21
9008580000	SDK PH2	F.21
9008590000	SDK PH3	F.21
9008640000	SDIZ 0.8X5.5 150/248	F.21
9008850000	SK WSD-S 1.5-10,0	F.25
9008860000	SKS 2,0-8,0	F.25
9008870000	SKS 2,0-8,0 MR	F.25
9008880000	THS 9-40	F.25
9008890000	SDK PZ2	F.21
9008900000	SDK PZ1	F.21
9008910000	SDIS 1.0X4.5X125	F.21
9009010000	SDS 1.2X6.5X150	F.23
9009020000	SDS 0.8X4.5X125	F.23
9009030000	SDS 0.4X2.5X75	F.23
9009070000	SK 10,0x125	F.23
9009160000	SK TH20	F.23
9009170000	SD TH15	F.23
9009180000	SK TH10	F.23
9009520000	UBH 1/4 E6,3	F.9
9009630000	BHS 1/4	F.9
9009730000	SDI Set S2.5-5.5/PH1/2	F.22
9009740000	SD Set S2.5-5.5/PH1/2	F.24
9009750000	SYSTEM 11+1	F.26

## 9010000000

9010110000	SDS 0.6X3.5X200	F.23
9010950000	HTX-HDC/POF	D.54
9011360000	HTX LWL	D.5
9011360000	HTX LWL	D.21
9011360000	HTX LWL	D.5
9011460000	PZ 6/5	D.8
9011460000	PZ 6/5	D.4
9011460000	PZ 6/5	J.3
9011460000	PZ 6/5	D.4
9011460000	PZ 6/5	J.3
9011980000	STRIPAX PLUS 2.5 ZERT	D.6
9011990000	HTX 188	D.25
9011990000	HTX 188	D.5
9012000000	HTG 58	D.25
9012000000	HTG 58	D.5
9012010000	HTG 59	D.25
9012010000	HTG 59	D.5
9012020000	HTG 58/59	D.25
9012020000	HTG 58/59	D.5
9012400000	HTX 138	D.25
9012400000	HTX 138	D.5
9012410000	HTG 174	D.25
9012410000	HTG 174	D.5
9012500000	PZ 4	D.8
9012500000	PZ 4	D.4

Order No.	Type	Page
9012500000	PZ 4	D.4
9012500000	PZ 4	J.3
9012500000	PZ 4	J.13
9012600000	PZ 16	D.11
9012600000	PZ 16	D.4
9012600000	PZ 16	J.3
9013080000	HTF 48	D.16
9013080000	HTF 48	D.5
9013090000	HTF 28	D.16
9013090000	HTF 28	D.5
9013260000	HTF SUB-D	D.26
9013260000	HTF SUB-D	D.5
9013400000	HTF 63	D.16
9013400000	HTF 63	D.5
9013550000	HTF RSV 12	D.27
9013550000	HTF RSV 12	D.4
9013560000	HTF RSV 16 WI	D.27
9013560000	HTF RSV 16 WI	D.4
9013600000	PZ ZH 16	D.11
9013600000	PZ ZH 16	D.4
9013600000	PZ ZH 16	J.3
9013610000	PZ ZH 16 ZERT	D.11
9013690000	CTX CM 1.6/2.5 ZERT	D.20
9013960000	ERME 110 PDT	D.51
9013970000	PUNCH DOWN TOOL PDT	D.51
9013980000	ERME 66 PDT	D.51
9013990000	ERME 630 PDT	D.51
9014000000	ERME LSA PLUS STANDARD	D.51
9014050000	ERME LSA PLUS SCHERE	D.51
9014100000	HTN 21 M. AN	D.18
9014100000	HTN 21 M. AN	D.5
9014140000	HTF OFF	D.27
9014140000	HTF OFF	D.4
9014210000	DFC-ENTRIEGELUNGSWZ.	D.52
9014350000	PZ 6 Roto	D.8
9014350000	PZ 6 Roto	D.4
9014350000	PZ 6 Roto	D.4
9014350000	PZ 6 Roto	J.3
9014400000	HTI 15	D.18
9014400000	HTI 15	D.5
9014400000	HTI 15	J.3
9014610000	HTN 21	D.18
9014610000	HTN 21	D.5
9014840000	HTF ZRV	D.27
9014840000	HTF ZRV	D.4
9015900000	FLECAFIX 11/24	F.16
9015980000	FLECAFIX 24/36	F.16
9016180000	EINSATZPAAR ISO 100MM	D.40
9016190000	EINSATZPAAR ISO 160MM	D.40
9016200000	EINSATZPAAR ISO 250MM	D.40
9016210000	EINSATZPAAR ISO 350MM	D.40
9016220000	EINSATZPAAR ISO 500MM	D.40
9016230000	EINSATZPAAR ISO 700MM	D.40
9016260000	RUNDPRESSEINS 25SM35SE	D.40
9016270000	RUNDPRESSEINS 35SM50SE	D.40
9016280000	RUNDPRESSEINS 50SM70SE	D.40
9016290000	RUNDPRESSEINS 70SM95SE	D.40
9016370000	RUNDPRESSEINS 95SM120SE	D.40
9016380000	RUNDPRESSEINS 120SM150SE	D.40
9016390000	RUNDPRESSEINS 150SM185SE	D.40
9016440000	RUNDPRESSEINS 185SM240SE	D.40
9017170000	HTN 21 M. AN ZERT	D.18
9017240000	HTF 63 ZERT	D.16
9017250000	MTR 160	D.39
9017260000	HTF 48 ZERT	D.16
9017270000	TRAGETASCHE MTR 160	D.39
9017290000	CTI 6 ZERT	D.17
9017300000	PZ 4 ZERT	D.8
9017310000	PZ 1.5 ZERT	D.7
9017330000	STRIPAX ZERT	C.4
9017340000	PZ 16 ZERT	D.11
9017350000	CTN 25 D4 ZERT	D.19
9017360000	PZ 3 ZERT	D.7
9017380000	HTN 21 ZERT	D.18
9017400000	PZ 50 ZERT	D.12
9017410000	HTF 28 ZERT	D.16
9017430000	HTI 15 ZERT	D.18
9017440000	PZ 6 ROTO ZERT	D.9
9017500000	MTR 35	D.33
9017500000	MTR 35	K.6
9017500000	MTR 35	K.7
9017840000	TRAGEKASTEN MTR 35	D.33
9017870000	DMS 3 ZERT	F.7
9017880000	HTF RSV 16 ZERT	D.27
9017890000	HTF-RSV 12 ZERT	D.27
9017900000	PZ 6/5 ZERT	D.8
9018020000	MTR 110	D.36
9018020000	MTR 110	K.6
9018020000	MTR 110	K.7
9018040000	TRAGEKASTEN MTR 110	D.36
9018480000	CTX CM 3.6	D.20
9018480000	CTX CM 3.6	D.4
9018490000	CTX CM 1.6/2.5	D.20
9018490000	CTX CM 1.6/2.5	D.4
9018510000	H0,75/14 ZH W SV	J.10
9018520000	H0,75/14D ZH GR SV	J.11
9018530000	H1,0/15 ZH GE SV	J.10
9018540000	H1,0/15D ZH R SV	J.11

Order No.	Type
-----------	------



Order No.	Type	Page
9021140000	H6/26T GN	J.8
9021150000	H10,0/22T BR	J.8
9021160000	H10,0/28T BR	J.8
9021170000	H16,0/22T W	J.8
9021180000	H16,0/28T W	J.8
9021190000	H25,0/30T SW	J.8
9021200000	H25,0/36T SW	J.8
9021210000	H0,25/10T GE SV	J.8
9021220000	H0,25/12T GE SV	J.8
9021230000	H0,75/14T HBL SV	J.8
9021240000	H2,5/15T GR SV	J.8
9021250000	H4,0/18T OR SV	J.8
9021300000	EINSATZ MTR 160 10DIN	0.40
9021310000	EINSATZ MTR 160 16DIN	0.40
9021320000	EINSATZ MTR 160 25DIN	0.40
9021330000	EINSATZ MTR 160 35DIN	0.40
9021340000	EINSATZ MTR 160 50DIN	0.40
9021350000	EINSATZ MTR 160 70DIN	0.40
9021360000	EINSATZ MTR 160 95DIN	0.40
9021370000	EINSATZ MTR 160 120DIN	0.40
9021380000	EINSATZ MTR 160 150DIN	0.40
9021390000	MTR 300	0.39
9021420000	TRAGEKASTEN MTR 300	D.39
9021430000	EINSATZP.HEX100MM	0.40
9021440000	EINSATZP.HEX160MM	0.40
9021450000	EINSATZP.HEX250MM	0.40
9021460000	EINSATZP.HEX350MM	0.40
9021470000	EINSATZP.HEX500MM	0.40
9021480000	EINSATZP.HEX700MM	0.40
9021750000	EINSATZ MTR 160 10+25WM	0.40
9021760000	EINSATZ MTR 160 16+35WM	0.40
9021770000	EINSATZ MTR 160 50WM	0.40
9021780000	EINSATZ MTR 160 70WM	0.40
9021790000	EINSATZ MTR 160 95WM	0.40
9021800000	EINSATZ MTR 160 120WM	0.40
9021810000	EINSATZ MTR 160 150WM	0.40
9021820000	EINSATZ MTR 160 185WM	0.40
9021830000	EINSATZ MTR 160 240WM	0.40
9022290000	EINSATZP.HEX950MM	0.40
9022300000	EINSATZP.HEX1200MM	0.40
9022310000	EINSATZP.HEX1500MM	0.40
9022320000	EINSATZP.HEX1850MM	0.40
9022330000	EINSATZP.HEX2400MM	0.40
9022340000	EINSATZP.HEX3000MM	0.40
9022350000	GESENK 10+700QMM	0.40
9022360000	GESENK 16+350QMM	0.40
9022370000	GESENK 25+500QMM	0.40
9022380000	GESENK 950QMM	0.40
9022390000	GESENK 1200QMM	0.40
9022400000	GESENK 1500QMM	0.40
9022990000	STEMPEL 10-700QMM	0.40
9023090000	H-BOX 0.5-2.5QMM T	J.16
9023100000	CUTFIX 8	I.5
9023110000	STEMPEL 95-1500MM	0.40
9024000000	BIT E6,3 0,5x3,0x7,0	F.8
9024010000	EINSATZP.WM 10+250MM	0.40
9024020000	BIT E6,3 0,6x3,5x7,0	F.8
9024030000	BIT E6,3 0,8x4,0x7,0	F.8
9024040000	BIT E6,3 1,0x5,5x7,0	F.8
9024080000	BIT E6,3 PH1x7,0	F.8
9024090000	BIT E6,3 PH2x7,0	F.8
9024100000	BIT E6,3 PZ1x7,0	F.8
9024110000	BIT E6,3 PZ2x7,0	F.8
9024400000	EINSATZP.WM 16+350QMM	0.40
9024410000	EINSATZP.WM 50QMM	0.40
9024420000	EINSATZP.WM 70QMM	0.40
9024430000	EINSATZP.WM 95QMM	0.40
9024970000	Bit-Box WI DMS 3	F.9
9025210000	EINSATZP.WM 120QMM	0.40
9025220000	EINSATZP.WM 150QMM	0.40
9025230000	EINSATZP.WM 185QMM	0.40
9025240000	H1,5/14S SW	J.14
9025390000	ZH-BOX 0,5-2,50MM	I.16
9025400000	H-BOX 4,0-16,0QMM DIN	J.17
9025410000	H-BOX 0,14-0,75QMM	J.16
9025420000	H-LEERBOX 4 TRENNSTEGE	J.17
9025430000	H-BOX 0,5-2,50QMM DIN	J.16
9025440000	CCM ABLAENGAUTOMAT	I.5
9025680000	H-LEERBOX 5 TRENNSTEGE	J.17
9025690000	H1,5/12S R	J.14
9025700000	H0,75/14S W SV	J.14
9025710000	H1,0/14S GE SV	J.14
9025720000	H1,5/14S R SV	J.14
9025740000	H0,25/10 HBL	J.4
9025750000	H0,34/10 TK	J.4
9025760000	H0,25/12 HBL	J.4
9025770000	H0,34/12 TK	J.4
9025780000	H0,25/12 HBL SV	J.4
9025790000	H0,34/12 TK SV	J.4
9025800000	CRIMP-SET PZ 4	H.6
9025850000	CRIMP-SET PZ 16	H.7
9025860000	H0,75/16 W	J.4
9025870000	H0,5/16 OR	J.4
9025880000	H50,0/22S	J.15
9025900000	H-BOX 0,5-2,50QMM	J.16
9025910000	H0,75/18 W	J.4
9025920000	H-BOX 4,0-16,0QMM	J.17
9025930000	H1,0/18 GE	J.4
9025940000	H-LEERBOX 5 EINSATZP	J.17

Order No.	Type	Page
9025950000	H1,0/16 GE	J.4
9025960000	H0,75/14S W	J.14
9025970000	H1,0/14S GE	J.14
9025980000	H1,5/14S R	J.14
9026010000	H4,0/18 GR SV	J.4
9026020000	H4,0/18 GR SV	J.6
9026030000	H0,34/10 TK SV	J.4
9026050000	H0,25/10 HBL SV	J.4
9026060000	H0,5/14 OR SV	J.4
9026070000	H0,75/14 W SV	J.4
9026080000	H1,0/14 GE SV	J.4
9026090000	H1,5/14 R SV	J.4
9026100000	H2,5/15 BL SV	J.4
9026100000	H2,5/15 BL SV	J.6
9027270000	POWERSTRIPPER ao 2,5-20	I.7
9027290000	POWERSTRIPPER ao 16-20	L.7
9027310000	CRIMPFIX LZ	I.10
9028020000	EINSATZP.WM 240QMM	D.40
9028200000	H70,0/37 GE	J.4
9028210000	H95,0/44 R	J.4
9028220000	H120,0/50 BL	J.4
9028230000	H150,0/54 GE	J.4
9028240000	H0,14/12 GR SV	J.4
9028250000	H0,14/10T BR SV	J.8
9028260000	H0,5/12 OR SV	J.4
9028270000	H0,5/16 OR SV	J.4
9028280000	H0,75/12 W SV	J.4
9028290000	H0,75/16 W SV	J.4
9028300000	H0,75/18 W SV	J.4
9028310000	H1,0/12 GE SV	J.4
9028320000	H1,0/16 GE SV	J.4
9028340000	H1,0/18 GE SV	J.4
9028350000	H1,5/16 R SV	J.4
9028360000	H1,5/14DS SW SV	J.14
9028420000	EINSATZ A8-2 CL55	H.12
9028450000	EINSATZ A7-1 CL55	H.12
9028460000	EINSATZ A8-1 CL55	H.12
9028480000	POWERSTRIPPER 16,0	I.6
9028490000	H2,5/12DS BL	J.14
9028500000	CRIMPFIX R	I.9
9028510000	POWERSTRIPPER 6,0	I.6
9028530000	CRIMPFIX L	I.10
9028540000	CRIMPFIX LS	I.10
9028580000	H0,75/14DS GR	J.14
9028630000	CRIMP-SET PZ 4 D	H.6
9028640000	CRIMP-SET PZ 4 T	H.6
9028650000	CRIMP-SET PZ 3	H.6
9028660000	CRIMP-SET PZ 3 D	H.6
9028670000	CRIMP-SET PZ 3 T	H.6
9028680000	CRIMP-SET PZ 6 ROTO L	H.6
9028690000	CRIMP-SET PZ 6 ROTO L D	H.6
9028700000	CRIMP-SET PZ 6 ROTO LT	H.6
9028740000	CRIMP-SET PZ 6/5	H.7
9028750000	CRIMP-SET PZ 6/5 D	H.7
9028760000	CRIMP-SET PZ 6/5 T	H.7
9028770000	CRIMP-SET STRIPAX PLUS	H.7
9028780000	CRIMP-SET STRIPAX PLUS D	H.7
9028790000	CRIMP-SET STRIPAX PLUS T	H.7
9028800000	CRIMP-SET PZ 16 D	H.7
9028810000	CRIMP-SET PZ 16 T	H.7
9028820000	CRIMP-SET PZ ZH 16	H.8
9028830000	CRIMP-SET PZ ZH 16 D	H.8
9028840000	CRIMP-SET PZ ZH 16 T	H.8
9028850000	CRIMP-SET PZ 50	H.8
9028860000	KOFFER PSCA-01	H.14
9028870000	CRIMP-SET PZ 50 D	H.8
9028880000	CRIMP-SET PZ 50 T	H.8

## 9030000000

9030060000	AM 12	C.12
9030500000	CST	C.14
9032060000	SCHA CST	C.14
9036200000	H2,5/12TS GR	J.14
9036220000	H2,5/16DS BL	J.14
9036240000	H120,0/32	J.15
9036250000	H150,0/32	J.15
9036260000	H185,0/32	J.15
9036290000	HOOKBLA 0,25-1,5 SW	J.18
9036300000	HOOKBLA 1,0-2,5 SW	J.18
9036330000	H1,0/22DS R ZH	J.11
9037160000	SDS 0.4X2.0X60	F.23
9037200000	H0,5/14 ZH OR	J.10
9037200000	H0,5/14 ZH OR	J.12
9037210000	H0,5/16 ZH OR	J.10
9037210000	H0,5/16 ZH OR	J.12
9037220000	H0,5/18 ZH OR	J.10
9037220000	H0,5/18 ZH OR	J.12
9037230000	H0,75/14 ZH W	J.10
9037240000	H0,75/16 ZH W	J.10
9037250000	H0,75/24 ZH W	J.10
9037260000	H1,0/15 ZH GE	J.10
9037270000	H1,0/19 ZH GE	J.10
9037280000	H1,0/25 ZH GE	J.10
9037290000	H1,5/16 ZH R	J.10
9037300000	H1,5/20 ZH R	J.10
9037310000	H1,5/26 ZH R	J.10
9037320000	H6,0/23 ZH SW	J.10
9037330000	H6,0/29 ZH SW	J.10

Order No.	Type	Page
9037340000	H10,0/24 ZH EB	J.10
9037350000	H10,0/30 ZH EB	J.10
9037360000	H16,0/29 ZH GN	J.10
9037370000	H16,0/38 ZH GN	J.10
9037380000	H0,5/14D ZH W	J.11
9037390000	H0,5/16D ZH W	J.11
9037400000	H0,5/18D ZH W	J.11
9037410000	H0,75/14D ZH GR	J.11
9037420000	H0,75/16D ZH GR	J.11
9037430000	H0,75/24D ZH GR	J.11
9037440000	H1,0/15D ZH R	J.11
9037440000	H1,0/15D ZH R	J.12
9037450000	H1,0/19D ZH R	J.11
9037450000	H1,0/19D ZH R	J.12
9037460000	H1,0/25D ZH R	J.11
9037460000	H1,0/25D ZH R	J.12
9037470000	H1,5/16D ZH SW	J.11
9037470000	H1,5/16D ZH SW	J.12
9037480000	H1,5/20D ZH SW	J.11
9037480000	H1,5/20D ZH SW	J.12
9037490000	H1,5/26D ZH SW	J.11
9037490000	H1,5/26D ZH SW	J.12
9037500000	H2,5/19D ZH BL	J.10
9037500000	H2,5/19D ZH BL	J.11
9037510000	H2,5/21D ZH BL	J.10
9037510000	H2,5/21D ZH BL	J.11
9037520000	H2,5/27D ZH BL	J.10
9037520000	H2,5/27D ZH BL	J.11
9037530000	H4,0/22D ZH GR	J.10
9037530000	H4,0/22D ZH GR	J.11
9037540000	H4,0/28D ZH GR	J.10
9037540000	H4,0/28D ZH GR	J.11
9037550000	H6,0/23D ZH GE	J.11
9037560000	H6,0/29D ZH GE	J.11
9037570000	H10,0/24D ZH R	J.10
9037580000	H10,0/30D ZH R	J.11
9037590000	H16,0/29D ZH BL	J.11
9037600000	H16,0/38D ZH BL	J.11
9037610000	H0,75/14T ZH HBL	J.12
9037620000	H0,75/16T ZH HBL	J.12
9037630000	H0,75/24T ZH HBL	J.12
9037640000	H2,5/19T ZH GR	J.12
9037650000	H2,5/21T ZH GR	J.12
9037660000	H2,5/27T ZH GR	J.12
9037670000	H4,0/22T ZH GR	J.12
9037680000	H4,0/28T ZH OR	J.12
9037690000	H6,0/23T ZH GN	J.12
9037700000	H6,0/29T ZH GN	J.12
9037710000	H10,0/24T ZH BR	J.12
9037720000	H10,0/30T ZH BR	J.12
9037730000	H16,0/29T ZH W	J.12
9037740000	H16,0/38T ZH W	J.12

## 9040000000

9041600000	SLICER 2K	B.16
9046280000	KBZ 160	E.3
9046290000	KBZ 180	E.3
9046300000	KBZ 200	E.3
9046310000	SE HD 140	E.4
9046320000	SE HD 160	E.4
9046330000	SE HD 180	E.4
9046340000	SE TOP	E.4
9046350000	FZ 160	E.6
9046360000	RZ 160	E.6
9046370000	FRZ S 160	E.5
9046380000	FRZ S 200	E.5
9046390000	FRZ SG 160	E.5
9046400000	FRZ SG 200	E.5
9046410000	KSE 160	E.4
9046420000	KSE 200	E.4
9046430000	KBZI 200	E.3

## 9050000000

9050340000	ERSATZMESSER STRIPAX PL	D.6
------------	-------------------------	-----

## 9200000000

9200070000	LIR 1,5M3 V	J.18
9200080000	LIR 1,5M3,5 V	J.18
9200090000	LIR 1,5M4 V	J.18
9200100000	LIR 1,5M5 V	J.18
9200110000	LIR 1,5M6 V	J.18
9200120000	LIR 1,5M8 V	J.18
9200150000	LIR 2,5M3 V	J.18
9200160000	LIR 2,5M3,5 V	J.18
9200170000	LIR 2,5M4 V	J.18
9200180000	LIR 2,5M5 V	J.18
9200190000		







# Addresses worldwide



## Let's connect.

- AE United Arab Emirates**  
Weidmüller Middle East FZE  
Warehouse Q3-79  
SAIF-Zone  
P.O. BOX 8591  
Sharjah  
Tel. +971 65572723  
Fax +971 65727224  
wme.info@weidmuller.com
- AO Angola**  
Please contact  
Phambili Interface  
South Africa
- AR Argentina**  
CPI SA  
Bauness 2660  
C1431DOF Buenos Aires  
Tel. +54 11 4523 8008  
Fax +54 11 4522 0546  
info@cpi.com.ar  
www.cpi.com.ar
- AT Austria**  
Weidmüller GmbH  
IZ NOE Süd Straße 2b, Obj  
M 59  
2355 Wiener Neudorf  
Tel. +43 2236 67080  
Fax +43 2236 6708-899  
office.at@weidmuller.com  
www.weidmuller.com
- AU Australia**  
Weidmüller Pty. Ltd.  
PO BOX 6944  
Huntingwood 2148  
Huntingwood Drive 43  
Huntingwood NSW 2148  
Tel. +61 2 9671 9999  
Fax +61 2 9671 9911  
info@weidmuller.com.au  
www.weidmuller.com.au
- AZ Azerbaijan**  
Representative Office  
Rashad Mahmudov  
Demirchi Tower, 4th floor  
37, Khojali ave.  
AZ 1025 Baku  
Tel. +994 12 488 80 36  
Fax +994 12 488 80 37  
rashad.mahmudov@  
weidmuller.com
- BA Bosnia and Herzegovina**  
Please contact  
our Representative Office  
Weidmüller Interface GmbH  
& Co. KG  
Serbia  
  
or  
  
BIG electric d.o.o  
Mladena Stojanovica 117A  
78000 Banja Luka  
Tel. +387 51926277  
Fax +387 51926277  
bigelectric@blic.net  
www.bigelectric.ba
- BE Belgium**  
Weidmüller Benelux B. V.  
Mechelsesteenweg 519 bus  
6 en 7  
1930 Nossegem  
Tel. +32 2 752 40 70  
Fax +32 2 751 36 06  
info@weidmuller.be  
www.weidmuller.be
- BG Bulgaria**  
Weid-Bul EOOD  
Bul. „Kliment Ohridski“ 13  
1756 Sofia  
Tel. +359 2 963 2560  
Fax +359 2 963 1098  
sofia@weidbul.com  
www.weidbul.com
- BH Bahrain**  
Khayber Trading Company  
P.O. Box 1976  
Manama  
Tel. +973 720747  
Fax +973 720331  
khayber@batelco.com.bh
- BR Brazil**  
Weidmüller Conexel do Brasil  
Conexões Elétricas Ltda.  
Av. Presidente Juscelino, 642  
- Piraporinha  
Diadema, São Paulo  
09950-370  
Tel. +55 (11) 4366-9600  
Fax +55 (11) 4362-1677  
vendas@weidmuller.com.br  
www.weidmuller.com.br
- BW Botswana**  
Please contact  
Phambili Interface  
South Africa
- BY Belarus**  
TECHNIKON Ltd.  
Nezavisimosti pr. 177-9  
220125 Minsk  
Tel. +375 17 393-11-77  
Fax +375 17 3930080  
wm@technikon.by
- CA Canada**  
W Interconnections Canada  
Inc.  
10 Spy Court  
Markham Ontario L3R 5H6  
Tel. +1 (905) 475-1507  
Ext. 9836  
Fax +1 (905) 475-2798  
support@weidmuller.ca  
www.weidmuller.ca
- CG Congo**  
Please contact  
Phambili Interface  
South Africa
- CH Switzerland**  
Weidmüller Schweiz AG  
Rundbuckstraße 2  
8212 Neuhausen am  
Rheinfall SH  
Tel. +41 52 674 07 07  
Fax +41 52 674 07 08  
info@weidmuller.ch  
www.weidmuller.ch
- CL Chile**  
ATS-INTECH  
María Luisa Santander 0475  
Santiago  
Providencia 7500859  
Tel. +56 2 341 1271  
Fax +56 2 341 1275  
felipe@atsintech.com  
www.atsintech.com  
  
CPI CHILE LTDA  
Av. Presidente Frei Montalva  
6001, 47 complejo el cortijo  
Santiago - Conchalí  
Tel. +562 963 8440  
Fax +562 963 8440  
cpi@cpichile.cl  
www.cpicichile.cl
- CN China**  
Weidmüller Interface  
(Shanghai) Co. Ltd.  
100 Yutong Road  
25 F, BM Intercontinental  
Business Center  
200070 Shanghai  
Tel. +86 21-22195008  
Fax +86 512-68417505  
customer.hotline@  
weidmuller.com.cn  
www.weidmuller.com.cn
- CO Colombia**  
Automatización Avanzada  
S. A.  
Carrera 97 No., 24 c- 23  
Bodega 4  
110911 Bogotá-D.C.  
Tel. +57 (1) 547-8510  
Fax +57 (1) 422-3044  
comercial@  
automatizacionavanzada.com  
www.  
automatizacionavanzada.com
- CR Costa Rica**  
ELVATRON S. A.  
la Uruca 400 Norte Banco  
Costa Rica  
San Jose Costa Rica  
Tel. +506 2961-060  
Fax +506 5200-609  
dirk.haase@elvatron.com  
www.elvatron.com
- CZ Czech Republic**  
Weidmüller s.r.o.  
Lomnického 5/1705  
140 00 Praha 4  
Tel. +420 244 001 400  
Fax +420 244 001 499  
office@weidmuller.cz  
www.weidmuller.cz
- DE Germany**  
Weidmüller GmbH & Co. KG  
Ohmstraße 9  
32758 Detmold  
Postfach 30 54  
32720 Detmold  
Tel. +49 5231 1428-0  
Fax +49 5231 14-292083  
weidmuller@weidmuller.de  
www.weidmuller.de
- DK Denmark**  
Weidmüller Danmark  
Vallensbækvej 18A  
2605 Brøndby  
Tel. +45 27747800  
kundeservice@weidmuller.dk  
www.weidmuller.dk
- EC Ecuador**  
Elsystec S. A., Electricidad  
Sistemas y Tecnología  
Vasco de Contreras N35-25 1  
y Mañosca  
Quito - Pichincha  
Tel. +593 22456510  
Fax +593 22456755  
Elsystec@uio.satnet.net
- EE Estonia**  
Please contact  
our Representative Office  
Weidmüller Interface GmbH  
& Co. KG  
Latvia  
  
or  
  
Soots Interface OÜ  
Pärnu mnt 142  
11317 Tallinn  
Tel. +372 609 6933  
Fax  
info@sootsinterface.ee  
www.sootsinterface.ee
- EG Egypt**  
Standard Electric (OMEGA)  
1, Abdelhamid Badawy Street  
Heliopolis  
Cairo  
Tel. +202 21805111  
Fax +202 21805600  
stdelec@rite.com
- ES Spain**  
Weidmüller, S. A.  
Narcis Monturiol 11-13, Pol.  
Ind. Sudoeste  
8960 Sant Just  
Desvern - Barcelona  
Tel. +34 934 803 386  
Fax +34 933 718 055  
weidmuller@weidmuller.es  
www.weidmuller.es
- FI Finland**  
Weidmüller Suomi,  
Weidmüller Aktiebolagetin  
sivulike  
Koy Plaza Vivace  
Äyritie 8C  
FI 1510 Vantaa  
Tel. +358 20 7351300  
Fax +358 800 114 667  
asiakaspalvelu@weidmuller.fi  
www.weidmuller.fi
- FR France**  
Weidmüller E. U. R. L.  
12, Chaussée Jules César  
BP 263 Osny  
95623 Cergy-Pontoise Cedex  
Tel. +33 1 34 24 65 00  
Fax +33 1 34 24 65 01  
mail@weidmuller.fr
- GB Great Britain**  
Weidmüller Ltd.  
Klippon House  
Centurion Court Office Park,  
Meridian East, Meridian  
Business Park  
Leicester  
LE19 1TP  
Tel. +44 116 282 3470  
Fax +44 116 289 3582  
marketing@weidmuller.co.uk  
www.weidmuller.co.uk
- GE Georgia**  
Please contact  
our Representative Office  
Rashad Mahmudov  
Azerbaijan.
- GH Ghana**  
Please contact  
Weidmüller Interface GmbH  
& Co. KG  
South Africa
- GR Greece**  
G.A. Solutions  
Ippokratous 11 Metamorfosi  
144 52 Athen  
Tel. +30 210 2823233  
Fax +30 210 2823233  
info@weidmuller.gr  
www.weidmuller.gr
- GT Guatemala**  
Prestelectro, Prestegard  
Electro, S.A.  
Avenida Petapa 44-22,  
Zona 12  
Guatemala City  
Tel. +502 2442-3346  
Fax +502 2476-8945  
ventas@prestelectro.com
- HK Hong Kong**  
Weidmüller (Hong Kong)  
Limited Co., Ltd.  
Unit 1617, Metropolis Tower  
No. 10 Metropolis Drive,  
Hung Hom, Kowloon  
Tel. +852 3154 8088  
Fax +852 31548099  
Info-hk@weidmuller.com.hk
- HR Croatia**  
ElektroPARTNER d.o.o.  
Slavonska avenija 24/6  
HR-10000 Zagreb  
Tel. +385 (1) 6184 793  
Fax +385 (1) 6184 795  
elektropartner@zg-tcom.hr  
www.elektropartner.hr
- HU Hungary**  
Weidmüller Kereskedelmi Kft.  
Budapest  
Gubacsi út 6.  
1097  
Tel. +36 1 382 7700  
Fax +36 1 382 7701  
info@weidmuller.hu  
www.weidmuller.hu
- ID Indonesia**  
PT. Nego Electrindo  
Ruko Mega Grosir Cempaka  
Mas Blok I No. 20 - 22  
Jakarta 10640  
Tel. +62 21 42882255  
Fax +62 21 42882266  
sales@negoelectrindo.co.id
- IE Ireland**  
Please contact  
Weidmüller Ltd.  
Great Britain
- IL Israel**  
A. U. Shay Ltd.  
23/25, Embar Street  
49222 Petach-Tikva  
P.O. Box 1 00 49  
49222 Petach-Tikva  
Tel. +972 3-923-3601  
Fax +972 3-923-4601  
shay@uriel-shay.com  
www.uriel-shay.com
- ATEKA Ltd.**  
4, Ha Tavor lane Industrial  
area Segula  
49691 Petach-Tikva  
P.O. Box 4710  
Petach-Tikva  
Tel. +972 73-200-1311  
Fax +972 3-924 4245  
marketing@ateka.co.il  
www.ateka.co.il
- IN India**  
Representative Office  
Weidmüller Electronics India  
Pvt. Ltd.  
12th Lane North Avenue, Opp  
Joggers Park,  
Kalyani Nagar, Pune  
411 006  
Tel. +91 20-41290090  
wmi.pune@weidmuller.in  
www.weidmuller.com
- IS Iceland**  
Samey Automation Center  
Lyngas 13  
210 Garabaer  
Tel. +354 510 5200  
Fax +354 510 5201  
Samey@samey.is  
www.samey.is
- IT Italy**  
Weidmüller S. r.l.  
Via Albert Einstein 4  
20092 Cinisello  
Balsamo Milano  
Tel. +39 02 660681  
Fax +39 02 6124945  
weidmuller@weidmuller.it  
www.weidmuller.it
- JM Jamaica**  
Please contact  
W Interconnections Inc.  
United States
- JO Jordan**  
Trans Jordan for Electro  
PO Box 33 06 07  
Amman  
Tel. +962 6 533 2020  
Fax +962 6 533 5800  
transjordan@batelco.jo
- JP Japan**  
Nihon Weidmüller Co. Ltd.  
Sphere Tower Tennoz 2-2-8  
Higashi-Shinagawa  
Shinagawa-ku  
Tokyo  
140-0002  
Tel. +81 3 6711 5300  
Fax +81 3 6711 5333  
weidmullerjapan@weidmuller.  
co.jp  
www.weidmuller.co.jp
- KE Kenya**  
Please contact  
Phambili Interface  
South Africa
- KR Korea**  
Weidmüller Korea Co. Ltd.  
9th floor, Wonbang B/D  
Samseong 2-Dong, Gangnam-Gu  
Seoul 143-42  
Tel. +82 2-516-0003  
Fax +82 2-516-0090  
info@weidmuller.co.kr  
www.weidmuller.co.kr
- KZ Kazakhstan**  
Please contact  
Weidmüller Group  
Russia
- LT Lithuania**  
Please contact  
our Representative Office  
Weidmüller Interface GmbH  
& Co. KG  
Latvia  
  
or  
  
ELEKTROS IRANGA  
Tinklų g. 29 a  
LT-5319 Panevėžys  
Tel. +370 (45) 582 828  
Fax  
info@eliranga.lt
- LU Luxembourg**  
Please contact  
Weidmüller Benelux B. V.  
Netherlands
- LV Latvia**  
SIA Abi4  
Daugavgrīvas 31b  
Rīga, LV-1007  
Petach-Tikva  
Tel. +371 674 70999  
Fax +371 674 24562  
abi\_4@tvnet.lv  
  
Representative Office  
Weidmüller Interface GmbH  
& Co. KG  
Udens str. 12-118  
Rīga, LV-1007  
Tel. +371 29254766  
Fax +371 674 65637  
Ilgonis.rudaks@weidmuller.  
com  
www.weidmuller.com



You can find all Weidmüller addresses and your local contact on the internet at: [www.weidmuller.com/countries](http://www.weidmuller.com/countries)

Let's connect.

Sales company   
Representation abroad   
without representation abroad 

- MD Moldova**  
BERHORD A & D srl  
79/1, str. Milescu Spartaru  
MD-2075 Chisinau  
Moldova  
Tel. +373 (22) 815002  
Fax +373 (22) 815007  
atiuleanu@berhord.com  
www.ad.berhord.com
- ME Montenegro**  
Please contact  
our Representative Office  
Weidmüller Interface GmbH  
& Co. KG  
Serbia.
- MG Madagascar**  
Please contact  
Phambili Interface  
South Africa
- MK Macedonia**  
Please contact  
our Representative Office  
Weidmüller Interface GmbH  
& Co. KG  
Serbia  
or  
ELEKTRO - SMK dool  
UL. III Makedonska brigada  
b.b.  
1000 Skopje  
Tel. +389 22460295  
Fax  
Elektro-smk@telekabel.net.mk
- MT Malta**  
E. S. S., Electrical Supplies &  
Services Ltd.  
San Gwakkim Road  
Mriehel  
Tel. +356 2 1255777  
Fax +356 2 1255999  
robert.agius@ess.com.mt
- MU Mauritius**  
Mubelo Electrical Ltd.  
Office 26, Gateway building,  
St Jean Road  
Quatre Bornes  
Mauritius  
Tel. +230 4670989  
Fax +230 4654051  
richard.mubelo@orange.mu
- MW Malawi**  
Please contact  
Phambili Interface  
South Africa
- MX Mexico**  
W Interconnections S. A.  
DE C. V.  
Blvd. Hermanos Serdán 698,  
Col. San Rafael Oriente  
72029 Puebla  
Tel. +52 (222) 268 6227  
Fax +52 (222) 286 6242  
clientes@weidmuller.com.mx
- MY Malaysia**  
Connect Plus Technology  
Sdn Bhd  
No. 43, Jalan PJS 11/22,  
Bandar Sunway  
46150 Petaling Jaya  
Selangor Darul Ehsan  
Tel. +60 3 5633 7363  
Fax +60 3 5633 6562  
paul@cptech.com.my  
www.cptech.com.my
- MZ Mozambique**  
Please contact  
Phambili Interface  
South Africa
- NA Namibia**  
Please contact  
Phambili Interface  
South Africa
- NG Nigeria**  
Please contact  
Weidmüller Interface GmbH  
& Co. KG  
South Africa
- NL Netherlands**  
Weidmüller Benelux B. V.  
Franciscusweg 22 I  
1216 SE Hilversum  
P.O. Box 1505  
1200 BM Hilversum  
Tel. +31 35 626 12 61  
Fax +31 35 623 20 44  
info@weidmuller.nl  
www.weidmuller.nl
- NO Norway**  
Sivilingeniør J.F. Knudtzen AS  
Billingstadsletta 97  
1396 Billingstad  
PO Box 160  
1378 Nesbru  
Tel. +47 66 98 33 50  
Fax +47 66 98 09 65  
firmapost@jfkknudtzen.no  
www.jfkknudtzen.no
- NZ New Zealand**  
Cuthbert S. Steward Ltd.  
27 Te Puni Street  
Petone  
PO Box 38496  
Wellington Mail Centre 5054  
Tel. (04) 568 6156  
Fax (09) 489 1752  
csi@cuthbertsteward.co.nz  
Cuthbert S. Steward Ltd  
4 Fred Thomas Drive  
Aon Building, Ground Floor,  
South Entry  
Takapuna  
PO Box 100 338  
North Shore City 745  
Tel. (09) 489 1751  
Fax (04) 568 6056  
cslak@cuthbertsteward.co.nz
- OM Oman**  
DAN INTERNATIONAL LLC.  
Ghala St. 111  
BP 2901  
Seeb  
Tel. +968 5036 77  
Fax +968 5037 55  
yed@danintl.com
- PE Peru**  
IMPEXINCA S.A.C.  
Calle Ortiz de Zavallos No.  
105, Urb. San Antonio  
18  
Lima, Miraflores  
Tel. +51 1 447 5608  
info@impexinca.pe  
www.impexinca.pe  
J & W CIA. S. A.  
Calle 6 Mz. D Lte. 23, Urb.  
Ind. Grimanesa  
01  
Callao  
Tel. +51 1 572 2539  
Fax +51 1 572 0152  
contacto@jwcia.com  
www.jwcia.com
- PH Philippines**  
Enclosure Systems Specialists  
Inc.  
2276 Don Chino Roces  
Avenue Extension  
Room 103/105 Narra Building  
1231 Makati City  
Tel. +63 2 813 8580  
Fax +63 2 813 8596  
sales\_encsys@pltdtdsl.net  
www.enclosuresystemsph.com
- PK Pakistan**  
Automation Controls (Pak)  
Apartment No. 33 C III,  
Chenab Block, Allama Iqbal  
Town  
Lahore  
Tel. +92 42 37809948  
Fax +92 42 37809950  
nadeem@aepak.com.pk  
www.aepak.com.pk
- PL Poland**  
Weidmüller Sp. z o. o.  
ul. Ogrodowa 58  
00-876 Warszawa  
Tel. +48 22 510 09 40  
Fax +48 22 510 09 41  
biuro@weidmuller.com.pl  
www.weidmuller.pl
- PR Puerto Rico**  
Please contact  
W Interconnections Inc.  
United States
- PT Portugal**  
Weidmüller Sistemas de  
Interface S. A.  
Estrada Outeiro Polima, R.  
Augusto Dias da Silva, Lote  
B - Esc. 2  
São Domingos de Rana  
2785-515 Abóboda  
Tel. +351 214 459 191  
Fax +351 214 455 871  
weidmuller@weidmuller.pt  
www.weidmuller.pt
- PY Paraguay**  
Please contact  
CPI SA  
Argentina
- RO Romania**  
Representative Office  
Weidmüller Interface GmbH  
& Co. KG  
Ionescu Crum Street, No.  
1, 1st Tower, 1st Floor,  
Office 4  
500446 Brasov - Brasov  
Business Park  
Tel. +40 (268) 446 222  
Fax +40 (262) 205 410  
claudiu.totea@weidmuller.com  
www.weidmuller.com
- RS Serbia**  
Representative Office  
Weidmüller Interface GmbH  
& Co. KG  
Ustanicka 189, III sprat  
lokal 7a  
11050 Beograd  
Tel. +381 112885274  
Fax +381 112885274  
zoran.rabrenovic@  
weidmuller.com
- RU Russia**  
Weidmüller Group  
7/10 Khelebozavodskiy  
Passage,  
Moskau  
115230  
Tel. +7 495 280 72 71  
Fax +7 495 280 72 71  
info@weidmuller.ru  
www.weidmuller.ru
- SA Saudi Arabia**  
Please contact  
Weidmüller Middle East FZE  
United Arab Emirates
- SE Sweden**  
Weidmüller AB  
Axel Danielssons väg 27 I  
BOX 31025  
SE-200 49 Malmö  
Tel. +46 77-143 00 44  
Fax +46 40-37 48 60  
info@weidmuller.se  
www.weidmuller.se
- SG Singapore**  
Weidmüller Pte. Ltd.  
70 Bendemeer Road  
# 04-03 Luzerner Building  
Singapore 339940  
Tel. +65 6841 5311  
Fax +65 6841 5377  
info@weidmuller.com.sg  
www.weidmuller.com.sg
- SI Slovenia**  
Elektrospoji d. o. o.  
Stegne 27  
SI- 1000 Ljubljana  
Osrednjėslovenska  
Tel. +386 1 511 3810  
Fax +386 1 511 1604  
info@elektrospoji.si  
www.elektrospoji.si
- SK Slovakia**  
ELEKTRIS s.r.o.  
Elektrárnská 1  
831 04 Bratislava  
Tel. +421 2/4920 0113  
Fax +421 2/4920 0119  
bratislava@elektris.sk
- SV El Salvador**  
Prestegard Electro  
11 Avenida Norte No. 240  
Edificio Salazar No. 2  
San Salvador  
Tel. +503 2271 1690  
Fax +503 2221 3851  
prestegard@navegante.com.sv
- SY Syria**  
Please contact  
Weidmüller Middle East FZE  
United Arab Emirates
- SZ Swaziland**  
Please contact  
Phambili Interface  
South Africa
- TH Thailand**  
Pisanu Engineering Co. Ltd.  
Kwang Dingaeng, Khet  
Dingaeng  
800/2 Soi Trakulsuk, Asoke-  
dindaeng Road  
Dindaeng, Bangkok  
10400  
Tel. +66 2 248 2896  
Fax +662 105 6301  
ecsales@pisanu.co.th  
www.pisanu.co.th  
Representative Office  
Weidmüller Pte. Ltd.  
37/F, Sathorn Square Building  
98 North Sathorn Road  
Bangkok, Silom Bangrak  
10500  
Tel. +66 2 105 6300  
Fax +66 2 642 9220  
info@weidmuller.com.sg
- TN Tunisia**  
Please contact  
Weidmüller E. U. R. L.  
France
- TR Turkey**  
Weidmüller Elektronik Ticaret  
Ltd. Sirketi  
Kavacik Mah. Orhan Veli Kanik  
Caddesi 9/1  
34810 Beykoz / Istanbul  
Tel. +90 (216) 537 10 70  
Fax +90 (216) 537 10 77  
info@weidmuller.com.tr  
www.weidmuller.com.tr
- TW Taiwan**  
Weidmüller (Hong Kong)  
Limited  
No. 3, Lane 89, ChungYang  
N. Rd  
24148 SanChuang City,  
Taipei  
Tel. +886 921 949 751  
roy.lin@weidmuller.com.hk
- TZ Tanzania**  
Please contact  
Phambili Interface  
South Africa
- UA Ukraine**  
LLC WM UKRAINE  
Levanevskogo str. 6  
Kiev  
3058  
Tel. +38 044 490 32 48  
Fax  
info@wm-ua.com.ua  
wm-ua.com.ua/  
Representative Office  
Weidmüller Interface GmbH  
& Co. KG  
Z, office 303  
7-D, Zdolbunivska str.  
Kiev, 2081  
Mobile +38 050 440 25 24  
info.ua@weidmuller.com
- US United States**  
W Interconnections Inc.  
821 Southlake Boulevard  
Richmond Virginia 23236  
Tel. +1 (804) 794-2877  
Fax +1 (804) 379-2593  
info@weidmuller.com  
www.weidmuller.com
- UZ Republic of Uzbekistan**  
Please contact  
Weidmüller Group  
Russia
- VN Vietnam**  
AUMI Industrial Equipment &  
Automation Company Limited  
E1, La Thanh Hotel  
218 Doi Can Street  
Lieu Giai Ward, Ba Dinh  
District  
Hanoi City  
Tel. +84 4 37628601  
Fax +84 4 62661391  
aumi@aumi.com.vn  
www.aumi.com.vn  
Representative Office  
Weidmüller Pte. Ltd.  
Level 16 Saigon Tower  
Building  
29 Le Duan Street  
District 1  
Ho Chi Minh  
Tel. +848 3520 7717  
Fax +848 3520 7604  
info@weidmuller.com.sg
- ZA South Africa**  
Phambili Interface  
PO Box 193  
1609 Johannesburg, Edenvale  
5 Bundo Road, Sebenza  
1610 Johannesburg  
Tel. +27 (11) 4521930  
Fax  
info@weidmuller.co.za  
www.weidmuller.co.za  
Representative Office  
Weidmüller Interface GmbH  
& Co. KG  
210 Amarand  
Avenue, Pegasus Building  
181 Pretoria, waterkloof Glen  
ext 2 -  
Tel. +27 12 003 2906  
Fax +27 (11) 4526455  
Jacques.Vosloo@weidmuller.com  
www.weidmuller.com
- ZM Zambia**  
Please contact  
Phambili Interface  
South Africa
- ZW Zimbabwe**  
Please contact  
Phambili Interface  
South Africa

We cannot guarantee that there are no mistakes in the publications or software provided by us to the customer for the purpose of making orders. We try our best to quickly correct errors in our printed media.

**X**

All orders are based on our general terms of delivery, which can be reviewed on the websites of our group companies where you place your order. On demand we can also send the general terms of delivery to you.





## **Weidmüller – Your partner in Industrial Connectivity**

As experienced experts we support our customers and partners around the world with products, solutions and services in the industrial environment of power, signal and data. We are at home in their industries and markets and know the technological challenges of tomorrow. We are therefore continuously developing innovative, sustainable and useful solutions for their individual needs. Together we set standards in Industrial Connectivity.

Weidmüller Interface GmbH & Co. KG  
Klingenbergstraße 16  
32758 Detmold, Germany  
T +49 5231 14-0  
F +49 5231 14-292083  
info@weidmueller.com  
www.weidmueller.com

Your local Weidmüller partner can  
be found on our website:  
[www.weidmueller.com/countries](http://www.weidmueller.com/countries)

Made in Germany



Order number: 2021630000/06/2015/SMKW