

**P**

**Paulmann**



**2022**







--	--	--	--	--	--	--	--	--	--

Kunden-Nr. / N° client / Klant nr.

Wir arbeiten auf der Grundlage unserer Liefer- und Zahlungsbedingungen.  
Diese erhalten Sie gerne auf Anfrage oder unter [www.paulmann.com](http://www.paulmann.com)

Toute commande implique l'acceptation de nos conditions générales de vente.  
Celles-ci sont à votre disposition sur simple demande ou sous [www.paulmann.com](http://www.paulmann.com).

Wij werken op basis van onze leverings- en betalingsvoorwaarden.  
Deze krijgt u na aanvraag of op [www.paulmann.com](http://www.paulmann.com)

14	Living room	
60	Wall & Ceiling	
72	Panels	
88	Downlights	
144	Spotlights	
150	Rail Systems	
184	Wire Systems CorDuo	
212	LED Strips & Profiles	
268	Assistance	
280	Furniture	
304	Bathroom	
320	Outdoor	
386	Transformers	
392	Lamps	
438	Technical information, indexes	



## Realisiere deine Licht-Ideen

Die Paulmann Licht GmbH mit Sitz im niedersächsischen Springe ist mit über 2500 innovativen Produkten einer der führenden Anbieter in der Lichtbranche und bietet sortimentsübergreifende Kompetenz – von Leuchten über Leuchtensysteme bis hin zum kompletten Leuchtmittelsortiment mit vielen Spezialitäten.

Paulmann-Produkte begeistern Ihre Kunden mit Licht zum Wohlfühlen, aktuellem Design und hoher Energieeffizienz.

Vertriebsniederlassungen und Vertretungen in rund 40 Ländern Europas sorgen dafür, dass die Kunden direkt vor Ort individuell betreut werden.

## Réalisez vos idées d'éclairage

La société Paulmann Licht GmbH implantée à Springe en Basse-Saxe, Allemagne est, avec plus de 2500 produits innovants, l'un des plus grands distributeurs de luminaires et offre une compétence dépassant le simple cadre de sa gamme de produits – depuis les lampes jusqu'aux assortiments complets d'ampoules aux caractéristiques variées en passant par les systèmes lumineux.

Les produits Paulmann séduisent vos clients avec une lumière dans laquelle on se sent bien, des designs actuels et une haute efficacité énergétique.

Les succursales et représentations commerciales, présentes dans environ 40 pays d'Europe permettent aux clients de bénéficier d'une prestation individuelle de conseil et de suivi directement sur place.

## Realiseer jouw lichtideeën

De firma Paulmann Licht GmbH is gevestigd in Springe (Duitse deelstaat Nedersaksen), en is met meer dan 2500 innovatieve producten een van de toonaangevende aanbieders in de lichtbranche. Bovendien staat de firma garant voor een competentie die ver boven het assortiment uitgaat - van armaturen, verlichtingsystemen tot een compleet assortiment verlichtingsmiddelen met vele specialiteiten.

Paulmann inspireert uw klanten met producten die gekenmerkt worden door het sfeervolle licht, het moderne design en de hoge energie-efficiëntie.

Vestigingen en vertegenwoordigingen in ruim 40 landen in Europa zorgen ervoor, dat de klanten direct ter plaatse individueel worden geholpen.



DE Performante Logistik-Power  
FR Performance Logistique  
NL Performante Logistik-Power

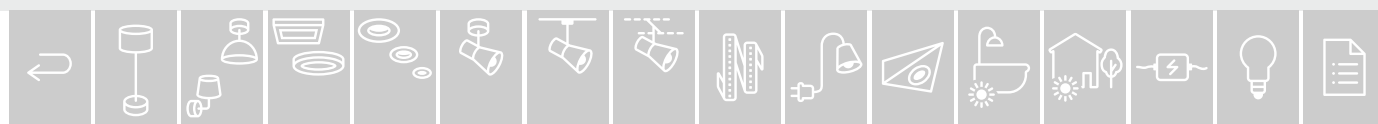



DE Starker Point-of-Sale-Auftritt erhöht Wertschöpfung  
 FR Nombreux points de vente pour encore plus de valeur ajoutée  
 NL Een krachtig Point-of Sale-optreden verhoogt het rendement

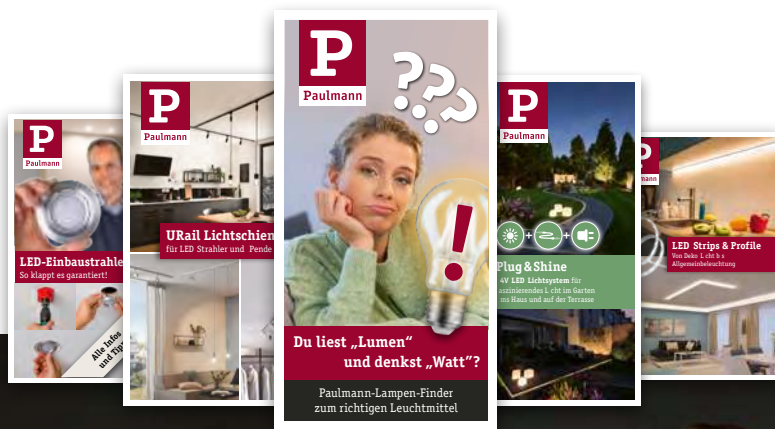

DE Einmalige Content-Komplettpakete  
 FR Packs de contenu complets absolument uniques  
 NL Eenmalige complete content-pakketten

**P Paulmann**  
 LICHTWELT

 **YouTube**

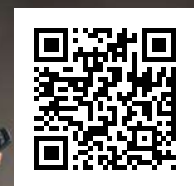

[www.youtube.com/PaulmannLicht](http://www.youtube.com/PaulmannLicht)



New



Panels  
Velora Rainbow  
□ = 78

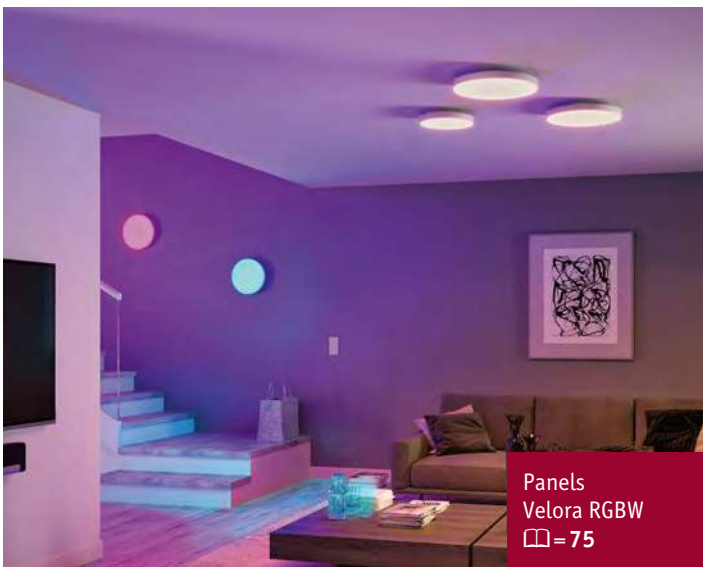

Panels  
Velora RGBW  
○ = 75

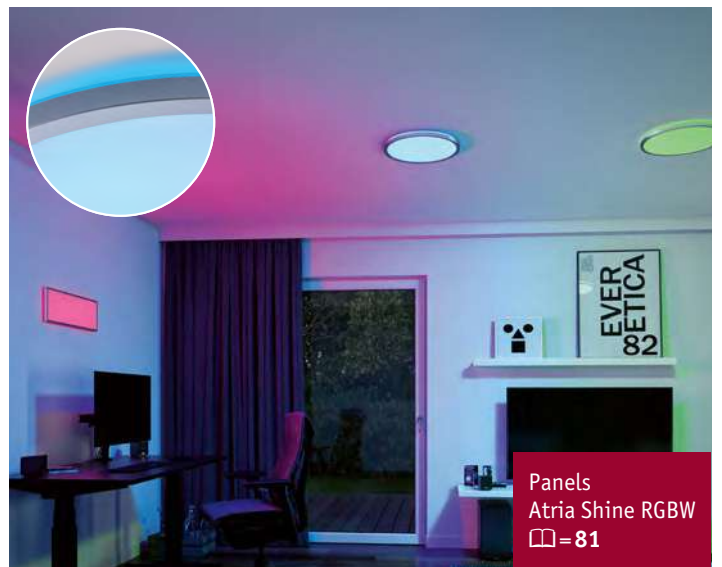

Panels  
Atria Shine RGBW  
○ = 81



Panels  
Atria Shine  
○ = 82

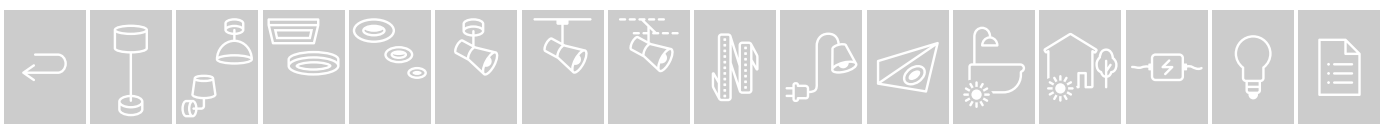



Downlights  
Gil  
☐=119



Living room  
Neordic Hilla  
☐=20



Living room  
Neordic Eldar  
☐=38

Lamps  
LED 1879 Edition Globe  
☐=413

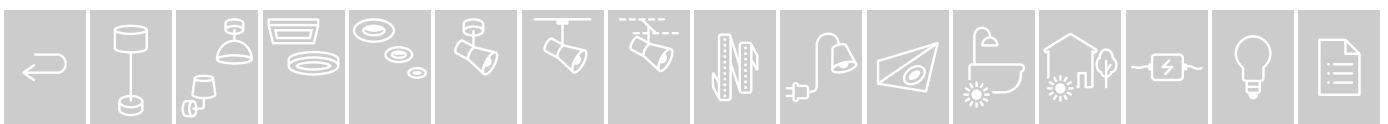







URail  
Spot Cone RGBW Zigbee  
□ = 162



Assistance  
Renan  
□ = 277



Profiles  
Square Profil  
□ = 258

Profiles  
Base Profil  
□ = 259

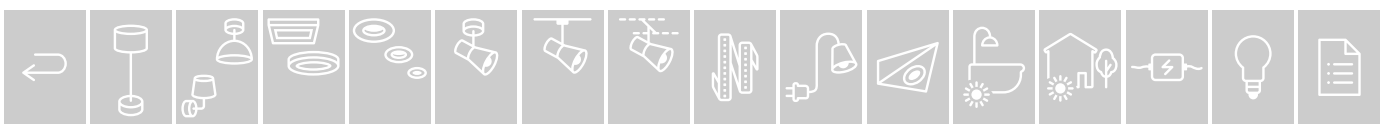

New



Wall/Ceiling  
Rainbow  
☐=61



Outdoor  
Solar Eileen  
☐=371

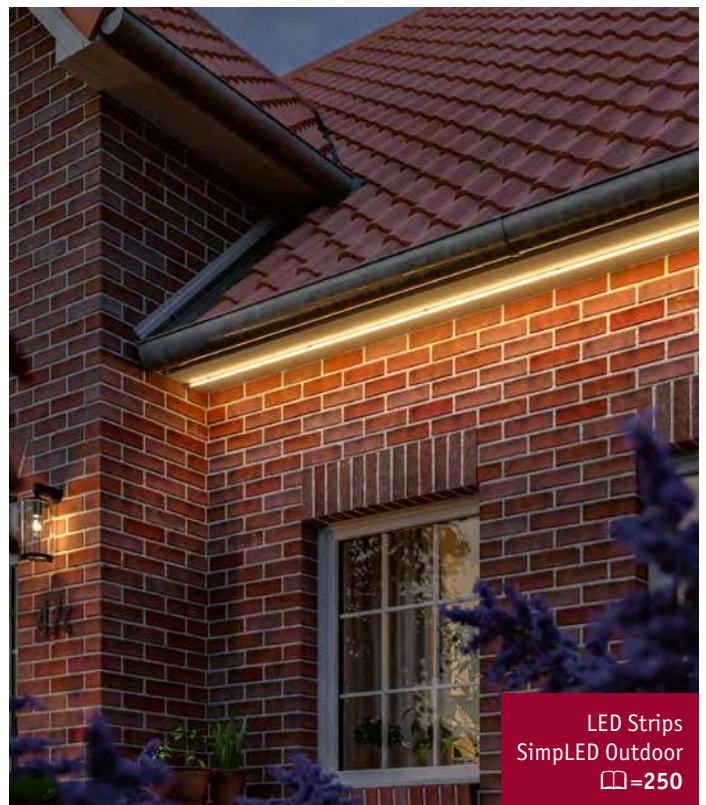

LED Strips  
SimpLED Outdoor  
☐=250





Park + Light

Outdoor  
Park + Light  
☐ = 346

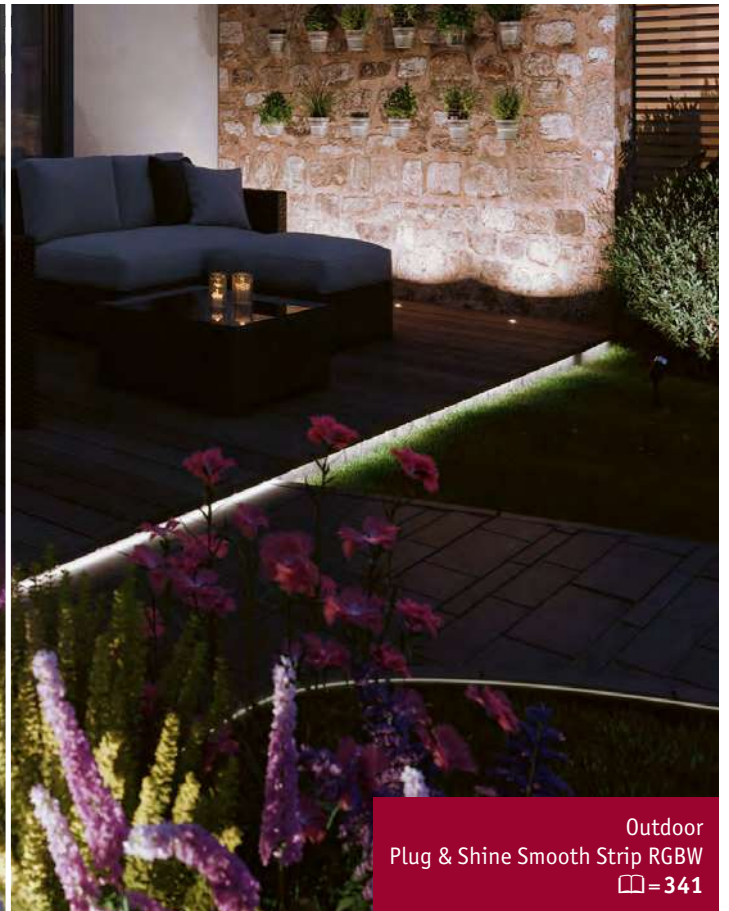

Outdoor  
Plug & Shine Smooth Strip RGBW  
☐ = 341

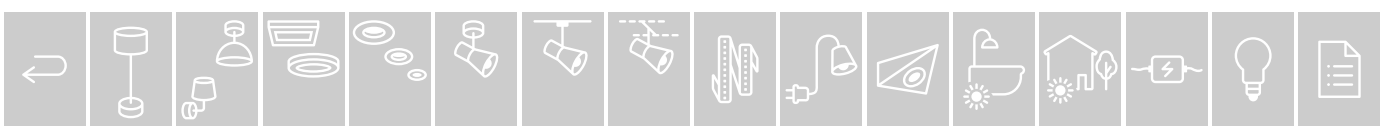

# Smart Home



DE Leuchtmittel FR Ampoules NL Verlichtingsmiddelen

## Smart Home

Durch die große Auswahl an smarten Leuchtmitteln und Leuchten entsteht in jedem Raum und im Garten ein atmosphärisches Lichtelebnis. Ob gemütliches Warmweiß, einstellbares Tunable White oder buntes RGBW, ob hell oder gedimmt – unsere smarten Produkte haben für jede Anwendung das richtige Licht. Lichtszenen lassen sich individuell für Bereiche oder Räume anlegen und komfortabel wieder aufrufen. Selbst bestehende Installationen können durch unsere cleveren Controller smart gesteuert werden. Die Steuerung erfolgt, je nach Technologie, einfach per App, Sprache oder Fernbedienung.

Le vaste choix d'ampoules et de luminaires connectés donne lieu à une expérience d'éclairage pleine d'ambiance dans toutes les pièces et le jardin. Agréable blanc chaud, Tunable White réglable ou RGBW multicolore, clair ou tamisé : nos produits connectés ont l'éclairage adapté à n'importe quelle application. Les scénarios d'éclairage peuvent être créés individuellement pour des zones ou des pièces, et reconfigurés facilement. Même les installations existantes se contrôlent intelligemment à l'aide de nos astucieux contrôleurs. Selon la technologie, la commande se fait facilement par application, commande vocale ou télécommande.

Door het grote aanbod van smart verlichtingsmiddelen en armaturen ontstaat er in elke ruimte en in de tuin een sfeervol lichteffect. Of het nu gezellig warmwit, instelbaar tunable white of kleurrijk RGBW, helder of gedimd is, onze smarte producten hebben voor elke toepassing het juiste licht. Lichtscènes kunnen individueel voor gebieden of voor ruimtes worden aangemaakt en eenvoudig worden opgeroepen. Zelfs bestaande installaties kunnen met behulp van onze intelligente controller smart worden bestuurd. Afhankelijk van de technologie zijn ze gemakkelijk bestuurbaar via app, spraak of afstandsbediening.

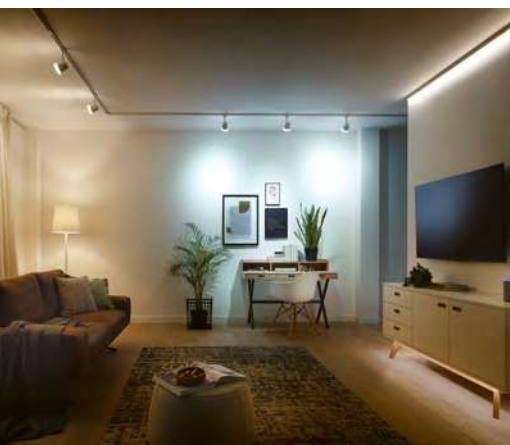

URail



Plug & Shine

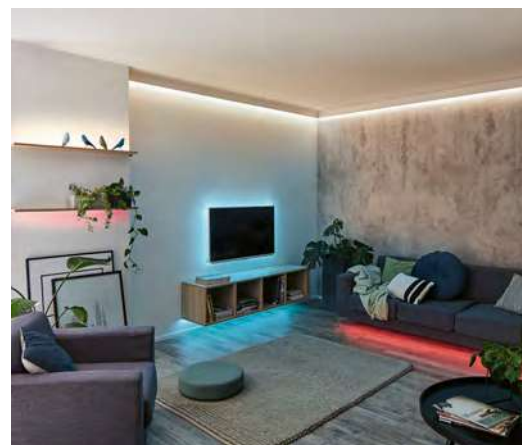

MaxLED Strips

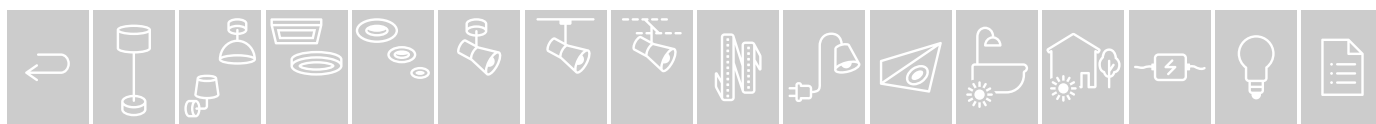



# Bluetooth®

Ganz einfach ohne weiteres Zubehör in die smarte Welt eintauchen und für einen Raum die Lichtatmosphäre individuell per Fernbedienung oder App anpassen. Die Paulmann App gibt es kostenlos zum Download.

Plonger tout simplement dans le monde connecté sans aucun autre accessoire, et adapter l'ambiance d'éclairage à la pièce par télécommande ou via l'application. L'application Paulmann est par ailleurs téléchargeable gratuitement.

Heel eenvoudig zonder verder toebehoren gebruik maken van de intelligente wereld en via afstandsbediening of app de lichtsfeer voor een ruimte individueel aanpassen. De Paulmann app is gratis te downloaden.



-  Living room □□=49
-  Wire Systems □□=186
-  LED Strips & Profiles □□=218, 229, 242-243

# Zigbee

Licht und weitere Smart Home Komponenten komfortabel in Haus und Garten vernetzen. Unsere Zigbee Lampen, Leuchten und Controller können mit Smart Home Zentralen, die über eine Zigbee Schnittstelle verfügen, genutzt oder direkt per Fernbedienung gesteuert werden. Auch eine Steuerung von unterwegs oder die Einbindung in Routinen ist in Abhängigkeit des verwendeten Systems möglich.





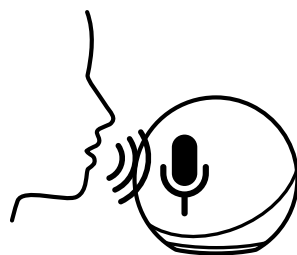

Connecter confortablement la lumière et les autres composants Smart Home à la maison et au jardin. Nos ampoules, luminaires et Controllers Zigbee se commandent et s'utilisent depuis des centrales Smart Home équipées d'une interface Zigbee ou directement à l'aide de la télécommande. Selon le système utilisé, même une commande en déplacement ou l'intégration dans des routines est possible.

Licht en andere Smart Home componenten comfortabel met elkaar verbinden in huis en tuin. Onze Zigbee lampen, armaturen en controllers kunnen met Smart Home centrales, die over een Zigbee interface beschikken, worden gebruikt. Ook kunnen ze rechtstreeks met een afstandsbediening worden bestuurd. Afhankelijk van het toegepaste systeem is ook een besturing op afstand of de integratie in routines mogelijk.

## Ready for

- Amazon Echo Smart Speaker with Zigbee
- Philips Hue Bridge 2 (excl.: Hue Entertainment)
- Paulmann Gent Remote Control 500.67



-  Living room □□=50
-  Panels □□=75, 79
-  Downlights □□=103, 118, 128, 132
-  Rail Systems □□=162, 183
-  LED Strips & Profiles □□=229, 242, 244
-  Outdoor □□=323, 327, 330-331, 338, 341, 343, 349, 359, 368, 370, 379
-  Lamps □□=430-431











- ▶ Zum direkten Steuern von Paulmann Bluetooth-Produkten
- ▶ Ermöglicht die Steuerung von bis zu sechs Licht-Gruppen
- ▶ Pour une commande directe des produits Bluetooth de Paulmann
- ▶ Permet de contrôler jusqu'à six groupes d'éclairage
- ▶ Voor het rechtstreeks besturen van Paulmann Bluetooth-producten
- ▶ Maakt de besturing van maximaal zes lichtgroepen mogelijk



#### Remote Control Boss

2xAAA/1,5V (Micro)  
 ⌀18 ⇄48 ↗110 mm  
 EAN 4000870 500019

**500.01** 

-  Schwarz  Kunststoff
-  Noir  Plastique
-  Zwart  Kunststof







- ▶ Bestehende Installationen nachträglich smart machen
- ▶ Einfach zwischen 230 V Anschluss und Leuchte bzw. Gerät montieren
- ▶ Steuerbar per Paulmann App via Bluetooth 4.0 oder Boss Fernbedienung
- ▶ Connecter ultérieurement les installations en place
- ▶ À monter simplement entre la prise 230 V et le luminaire ou l'appareil
- ▶ Commande par l'appli Paulmann via Bluetooth 4.0 ou télécommande Boss
- ▶ Bestaande installaties achteraf updaten naar een smart systeem
- ▶ Eenvoudig tussen 230 V aansluiting en lamp, resp. apparaat monteren
- ▶ Bestuurbaar met Paulmann app via Bluetooth 4.0 of Boss afstandsbediening



#### Master Switch

max. 500 W  
 220-240 V  
 $\Omega$  max. 500 W, C max. 75 W, I max. 75 W  
 ⌀26 ⇄47 ↗136 mm  
 EAN 4000870 500170

**500.17** 





-  Weiß  Kunststoff
-  Blanc  Plastique
-  Wit  Kunststof



#### Master Switch/Dimm

max. 300 W  
 220-240 V  
 $\Omega$  max. 300 W, I max. 100 W  
 ⌀26 ⇄47 ↗136 mm  
 EAN 4000870 500187

**500.18** 

-  Weiß  Kunststoff
-  Blanc  Plastique
-  Wit  Kunststof

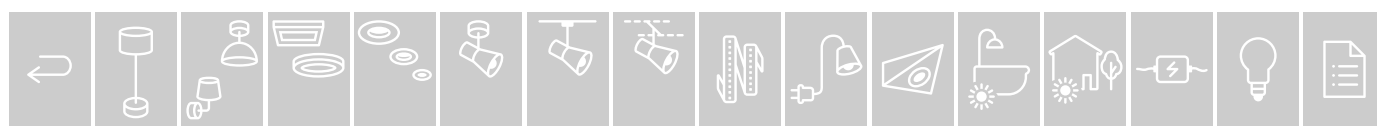



- ▶ Zum direkten Steuern smarter Zigbee Produkte
- ▶ Einfach per Knopdruck Weiß- oder Farbtöne einstellen, dimmen und schalten
- ▶ Produkte lassen sich einzeln oder in bis zu drei Gruppen steuern
- ▶ Pour une commande directe des produits connectés Zigbee
- ▶ Réglage blanc ou couleurs, variation et commutation simplement par pression d'une touche
- ▶ Les produits peuvent être commandés individuellement ou en groupes (jusqu'à trois).
- ▶ Voor het rechtstreeks besturen van smarte Zigbee producten
- ▶ Eenvoudig met een druk op de knop witte kleuren of kleurnuances instellen, dimmen en schakelen
- ▶ Producten kunnen apart of in maximaal drie groepen worden bestuurd



**Gent Remote Control**

2xAAA/1,5V (Micro)  
 ⌀18 ↔55 ↗138 mm  
 EAN 4000870 500675

**500.67**

- 🔗 Schwarz 📦 Kunststoff
- 🔗 Noir 📦 Plastique
- 🔗 Zwart 📦 Kunststof



- ▶ Zigbee Controller zum smarten Nachrüsten unterschiedlichster Geräte von verschiedenen Herstellern
- ▶ Einfach zwischen 230 V Anschluss und Leuchte bzw. Gerät montieren
- ▶ Contrôleur Zigbee pour un rééquipement connecté de divers appareils en provenance de différents fabricants
- ▶ À monter simplement entre la prise 230 V et le luminaire ou l'appareil
- ▶ Zigbee controller om verschillende apparaten van uiteenlopende fabrikanten achteraf smart te updaten
- ▶ Eenvoudig tussen 230 V aansluiting en lamp, resp. apparaat monteren



**Cephei Switch**

max. 1.000 W  
 230 V  
 Ω max. 1.000 W, C max. 75 W, I max. 75 W  
 ⌀28 ↔95 ↗38 mm  
 EAN 4000870 500439

**500.43**

- 🔗 Weiß/Grau 📦 Kunststoff
- 🔗 Blanc/Gris 📦 Plastique
- 🔗 Wit/Grijs 📦 Kunststof



**Cephei Switch/ Dimm**

max. 400 W  
 230 V  
 Ω max. 400 W, C max. 150 W,  
 ⌀53 ↔163 ↗60 mm  
 EAN 4000870 500446

**500.44**

- 🔗 Weiß/Grau 📦 Kunststoff
- 🔗 Blanc/Gris 📦 Plastique
- 🔗 Wit/Grijs 📦 Kunststof

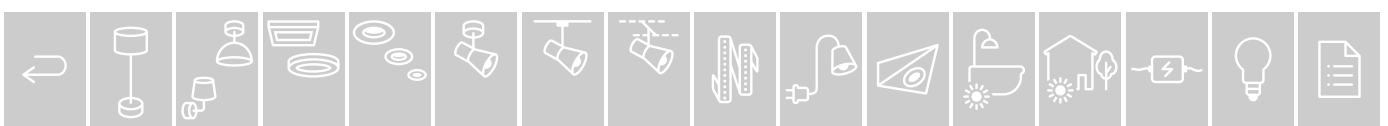

# Living room

18 Neordic

46 Puric

55 Classic

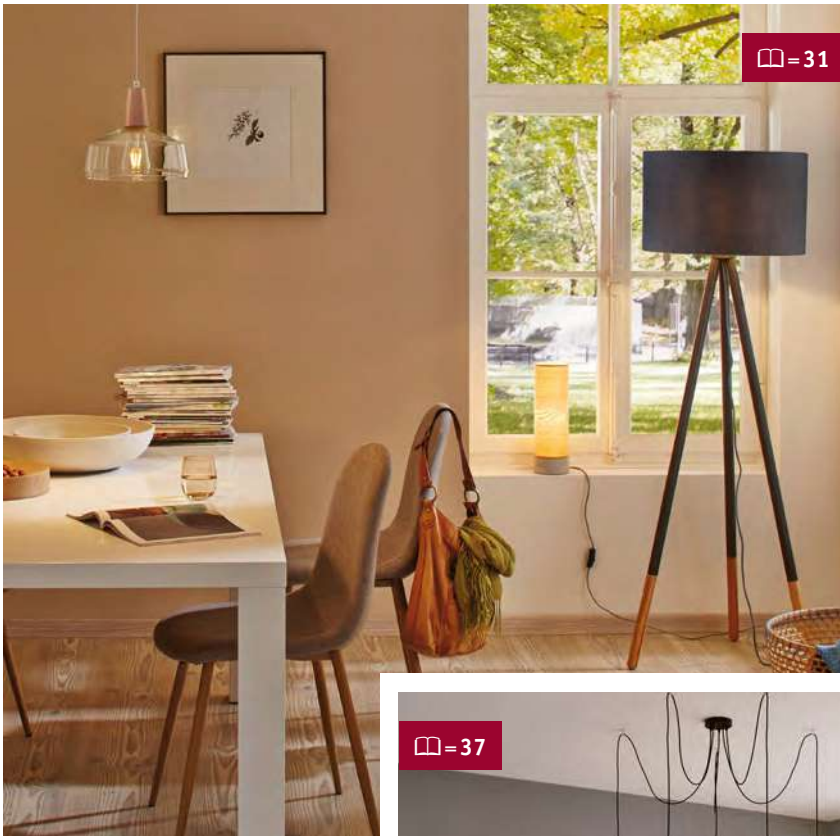

☰=31

## Neordic

DE Skandinavische, moderne und natürliche Leuchten aus Echtholz, echtem Beton und echtem Marmor

FR Luminaires scandinaves, modernes et naturels en bois véritable, béton et marbre authentique

NL Scandinavische, moderne en natuurlijke armaturen van echt hout, echt beton en echt marmer



☰=37

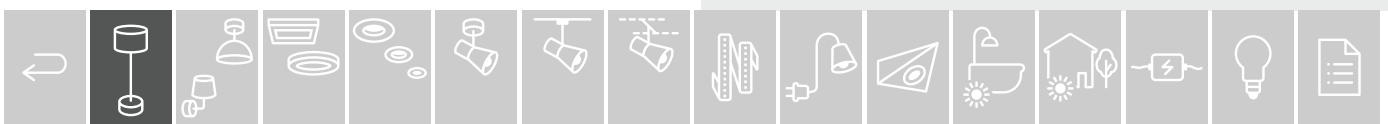



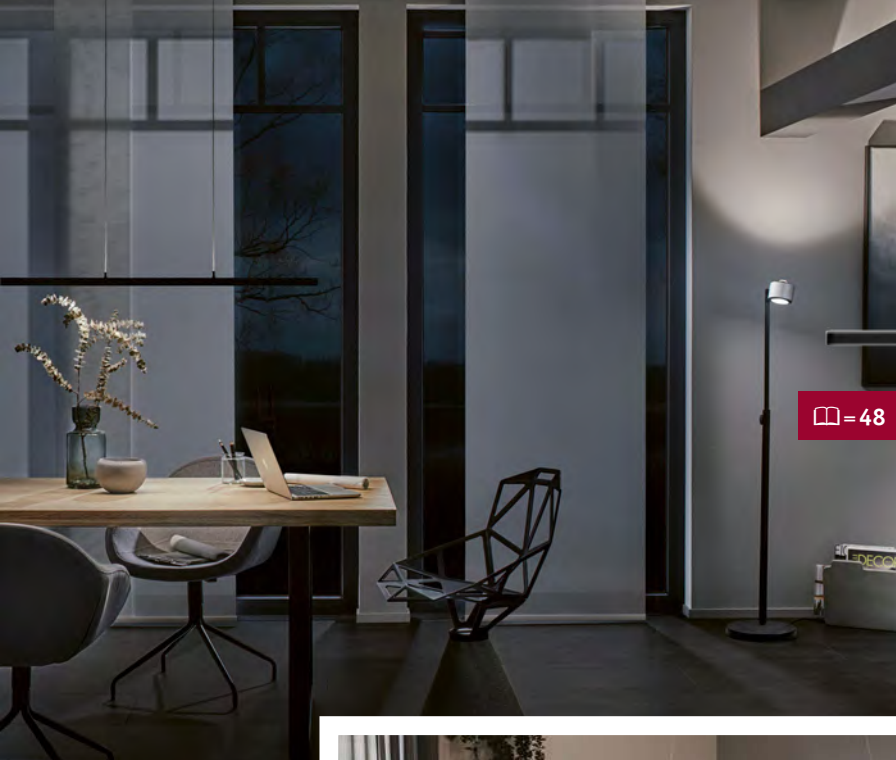

☑ = 48

## Puric

DE Leuchten in reduziertem Design mit moderner Technik und faszinierenden Lichteffekten

FR Luminaires au style minimaliste alliant technique moderne et de fascinants effets lumineux

NL Armaturen in minimalistisch design met moderne technologie en fascinerende lichteffecten



☑ = 50

## Classic

DE Klassisch und zeitlos designte Leuchten

FR Designs de luminaires classiques et intemporels

NL Armaturen in klassiek en tijdloos design



☑ = 55





795.21 □ = 18



797.60 □ = 19



797.64 □ = 20



797.68 □ = 21



797.48 □ = 23



797.30 □ = 24



797.56 □ = 24



797.43 □ = 25



797.24 □ = 26



797.39 □ = 27

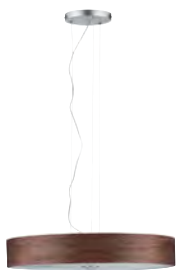

796.86 □ = 28



796.64 □ = 29



796.50 □ = 29



796.40 □ = 29



796.34 □ = 30



796.46 □ = 30



796.33 □ = 31



796.51 □ = 32



796.29 □ = 33



796.44 □ = 33



796.58 □ = 34



796.90 □ = 35



796.82 □ = 35



503.82 □ = 36



503.89 □ = 37





503.86 □ = 38



503.85 □ = 38



796.09 □ = 40



796.12 □ = 40



797.51 □ = 40



796.15 □ = 41



503.88 □ = 43



796.21 □ = 43



796.63 □ = 44



796.17 □ = 44



796.22 □ = 44



796.24 □ = 45



796.65 □ = 45



797.17 □ = 47

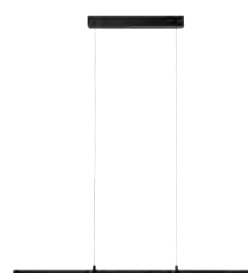

796.93 □ = 49



798.15 □ = 50



797.21 □ = 51



797.69 □ = 53



709.29 □ = 54



709.28 □ = 55



709.25 □ = 55



709.23 □ = 57



770.58 □ = 58



770.56 □ = 59



770.57 □ = 59

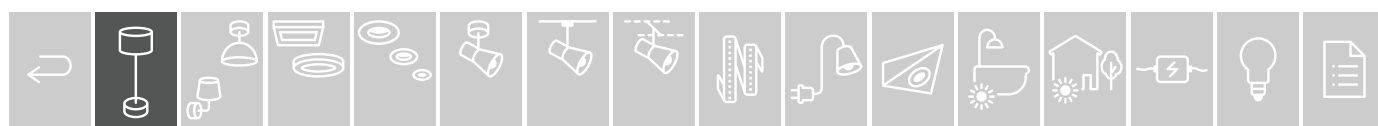

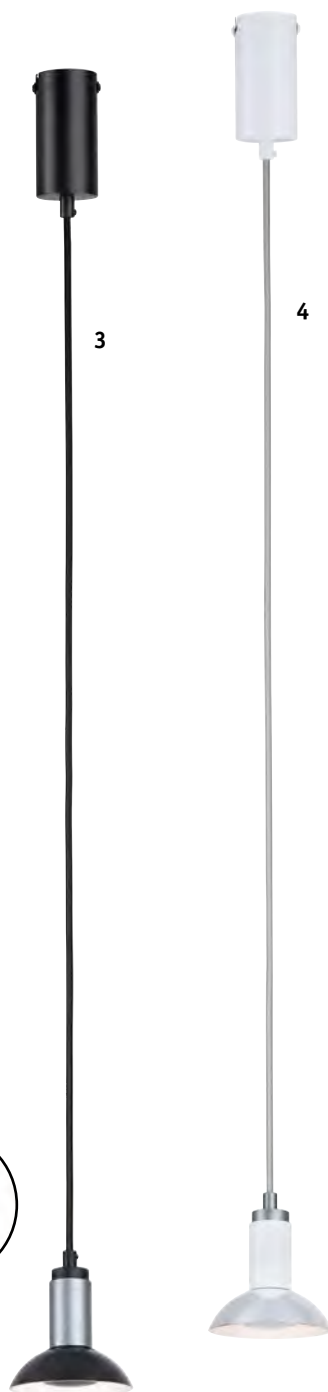

**1 Runa**  
 max. 20W, GU10  
 230V  
 ⚡164 ↔55 ↗50 mm  
 EAN 4000870 795200  
**795.20** **new**  
 ⚡ Schwarz/Anthrazit Metall  
 ⚡ Noir/Anthracite Métal  
 ⚡ Zwart/Antraciet Metaal

**2 Runa**  
 max. 20W, GU10  
 230V  
 ⚡164 ↔55 ↗50 mm  
 EAN 4000870 795231  
**795.23** **new**  
 ⚡ Weiß/Grau Metall  
 ⚡ Blanc/Gris Métal  
 ⚡ Wit/Grijs Metaal

**3 Runa**  
 max. 20W, GU10  
 230V  
 ⚡200 cm ø55 mm  
 EAN 4000870 795194  
**795.19** **new**  
 ⚡ Schwarz/Anthrazit Metall  
 ⚡ Noir/Anthracite Métal  
 ⚡ Zwart/Antraciet Metaal

**4 Runa**  
 max. 20W, GU10  
 230V  
 ⚡200 cm ø55 mm  
 EAN 4000870 795224  
**795.22** **new**  
 ⚡ Weiß/Grau Metall  
 ⚡ Blanc/Gris Métal  
 ⚡ Wit/Grijs Metaal

**5 Runa**  
 max. 20W, GU10  
 230V  
 ⚡164 ↔55 mm  
 EAN 4000870 795217  
**795.21** **new**  
 ⚡ Schwarz/Anthrazit Metall  
 ⚡ Noir/Anthracite Métal  
 ⚡ Zwart/Antraciet Metaal

**6 Runa**  
 max. 20W, GU10  
 230V  
 ⚡164 ↔55 mm  
 EAN 4000870 795248  
**795.24** **new**  
 ⚡ Weiß/Grau Metall  
 ⚡ Blanc/Gris Métal  
 ⚡ Wit/Grijs Metaal





**1 Kine**  
 max. 20 W, E27  
 230 V  
 ⚡ 150 cm ø100 mm  
 EAN 4000870 797570  
**797.57**

🔗 Schwarz Metall  
 🔗 Noir Métal  
 🔗 Zwart Metaal

**2 Malja**  
 max. 20 W, E27  
 230 V  
 ⚡ 125 ø100 mm  
 EAN 4000870 797600  
**797.60**

🔗 Schwarz Metall  
 🔗 Noir Métal  
 🔗 Zwart Metaal

**3 Skogen**  
 max. 3×20 W, E27  
 230 V  
 ⚡ 145 ø240 mm  
 EAN 4000870 797617  
**797.61**

🔗 Schwarz Metall  
 🔗 Noir Métal  
 🔗 Zwart Metaal

**4 Aik**  
 max. 20 W, E27  
 230 V  
 ⚡ 120 ø45 ⇄45  
 ⚡ 150 mm  
 EAN 4000870 797624  
**797.62**

🔗 Schwarz Metall  
 🔗 Noir Métal  
 🔗 Zwart Metaal

**5 Haldor**  
 max. 20 W, E27  
 230 V  
 ⚡ 95 ø120 mm  
 EAN 4000870 797587  
**797.58**

🔗 Schwarz Metall  
 🔗 Noir Métal  
 🔗 Zwart Metaal

**6 Haldor**  
 max. 20 W, E27  
 230 V  
 ⚡ 95 ø120 mm  
 EAN 4000870 797594  
**797.59**

🔗 Eisen gebürstet Metall  
 🔗 Acier brossé Métal  
 🔗 Staal geborsteld Metaal

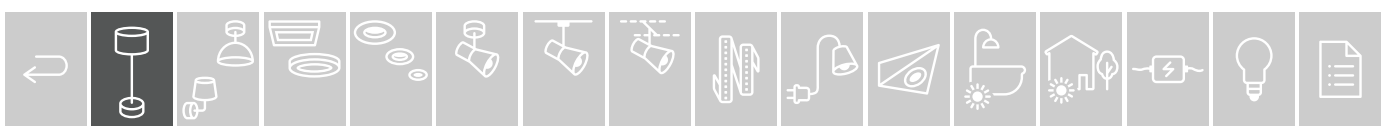



Perfect match

□ = 409-411  
432

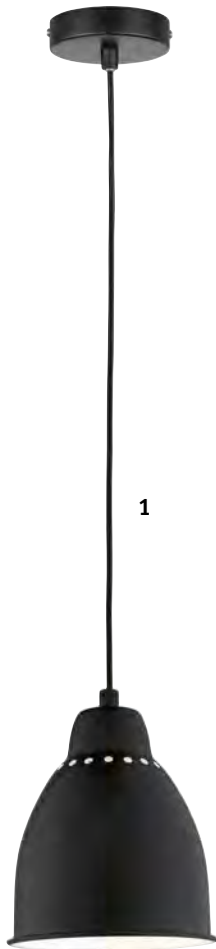

1

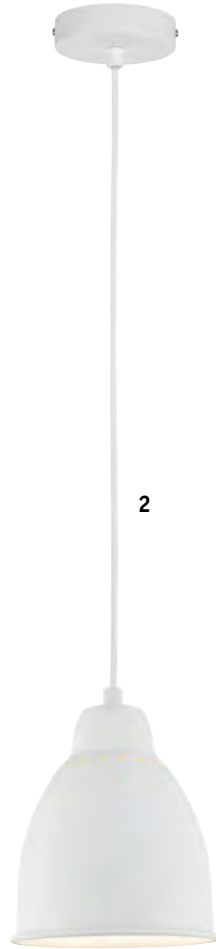

2

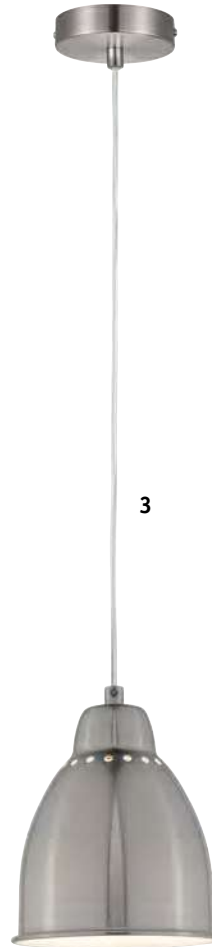

3

**1 Hilla**  
max. 40W, E27  
230V  
⌀180 cm ø145 mm  
EAN 4000870 797631  
**797.63** **new**  
🔧 Schwarz Metall  
🔧 Noir Métal  
🔧 Zwart Metaal

**2 Hilla**  
max. 40W, E27  
230V  
⌀180 cm ø145 mm  
EAN 4000870 797648  
**797.64** **new**  
🔧 Weiß Metall  
🔧 Blanc Métal  
🔧 Wit Metaal

**3 Hilla**  
max. 40W, E27  
230V  
⌀180 cm ø145 mm  
EAN 4000870 797655  
**797.65** **new**  
🔧 Eisen gebürstet Metall  
🔧 Acier brossé Métal  
🔧 Staal geborsteld Metaal

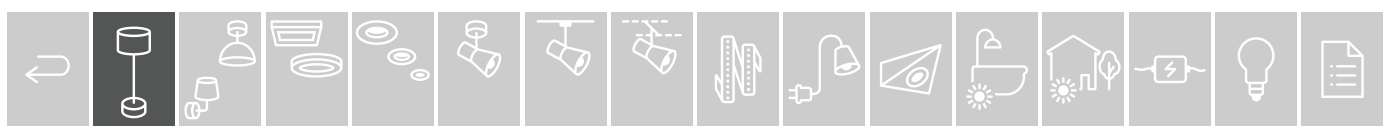



**1 Lavea**  
max. 15 W, E27  
230 V  
⇆ 180 cm ø 100 mm  
EAN 4000870 797662  
**797.66** new  
↳ Schwarz Metall  
↳ Noir Métal  
↳ Zwart Metaal

**2 Lavea**  
max. 15 W, E27  
230 V  
⇆ 180 cm ø 100 mm  
EAN 4000870 797679  
**797.67** new  
↳ Weiß Metall  
↳ Blanc Métal  
↳ Wit Metaal

**3 Lavea**  
max. 15 W, E27  
230 V  
⇆ 180 cm ø 100 mm  
EAN 4000870 797686  
**797.68** new  
↳ Eisen gebürstet Metall  
↳ Acier brossé Métal  
↳ Staal geborsteld Metaal



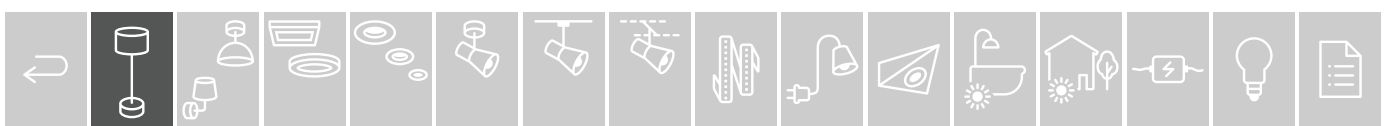





**1 Tasja**

max. 20 W, E27  
230 V  
↑4,35-110 cm  
↔300 ↗120 mm  
EAN 4000870 797488



**797.48**

- 🔧 Schwarz/Kupfer ☒ Metall
- 🔧 Noir/Cuivre ☒ Métal
- 🔧 Zwart/Koper ☒ Metaal

**2 Fanja**

max. 20 W, GU10  
230 V  
↑38-110 cm ø115 mm  
EAN 4000870 797495



**797.49**

- 🔧 Schwarz/Kupfer ☒ Metall
- 🔧 Noir/Cuivre ☒ Métal
- 🔧 Zwart/Koper ☒ Metaal

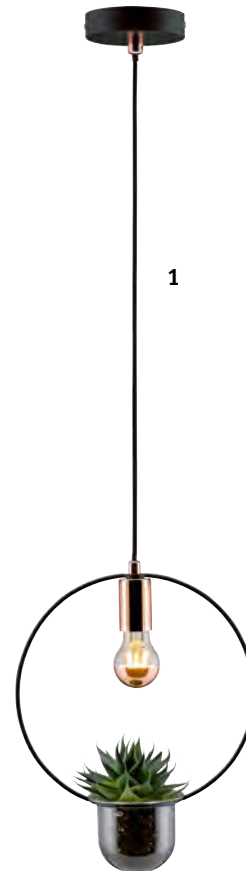

1



2

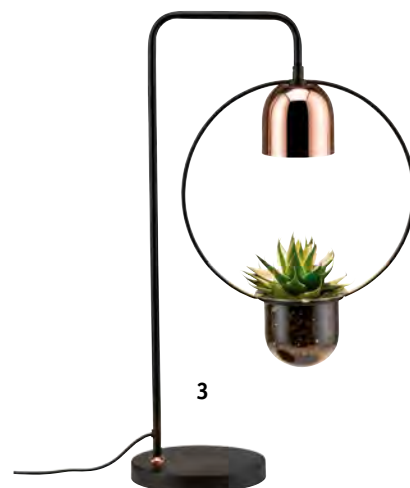

3

**3 Fanja**

max. 20 W, GU10  
230 V  
↑625 ↔370 ↗180 mm  
EAN 4000870 797464



**797.46**

- 🔧 Schwarz/Kupfer ☒ Metall
- 🔧 Noir/Cuivre ☒ Métal
- 🔧 Zwart/Koper ☒ Metaal

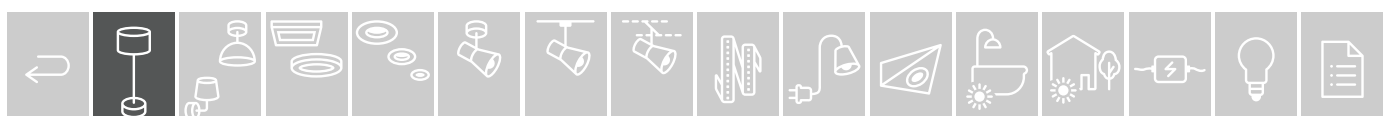



**Dilja**  
 max. 20 W, E27  
 230 V  
 ⚡85 ↔85 ⚡85 mm  
 EAN 4000870 797280  
**797.28**  
 ✎ Messing gebürstet 🗇 Metall  
 ✎ Laiton brossé 🗇 Métal  
 ✎ Messing geborsteld 🗇 Metaal



**Kura**  
 max. 20 W, E27  
 230 V  
 ⚡85 ↔85 ⚡85 mm  
 EAN 4000870 797303  
**797.30**  
 ✎ Eisen gebürstet 🗇 Metall  
 ✎ Acier brossé 🗇 Métal  
 ✎ Staal geborsteld 🗇 Metaal



**1 Stian**  
 max. 20 W, E27  
 230 V  
 ⚡150 cm ⚡155 mm  
 EAN 4000870 797556  
**797.55**  
 ✎ Messing gebürstet 🗇 Metall  
 ✎ Laiton brossé 🗇 Métal  
 ✎ Messing geborsteld 🗇 Metaal



**2 Kine**  
 max. 20 W, E27  
 230 V  
 ⚡150 cm ⚡100 mm  
 EAN 4000870 797563  
**797.56**  
 ✎ Messing gebürstet 🗇 Metall  
 ✎ Laiton brossé 🗇 Métal  
 ✎ Messing geborsteld 🗇 Metaal





**1 Linja**

max. 20W, E27  
230V  
110 cm ø165 mm  
EAN 4000870 797433



**797.43**

- ☞ Rauchglas/Messing gebürstet
- ☞ Spiegel/Glas/Metall
- ☞ Verre fumé/Laiton brossé
- ☞ Miroir/Verre/Métal
- ☞ Rookglas/Messing geborsteld
- ☞ Spiegel/Glas/Metaal

**2 Esben**

max. 20W, E27  
230V  
110 cm ø200 mm  
EAN 4000870 797259



**797.25**

- ☞ Klar/Messing gebürstet
- ☞ Glas/Metall
- ☞ Clair/Laiton brossé
- ☞ Verre/Métal
- ☞ Helder/Messing geborsteld
- ☞ Glas/Metaal

**3 Menja**

max. 20W, E27  
230V  
110 cm ø200 mm  
EAN 4000870 797334



**797.33**

- ☞ Weiß/Messing gebürstet
- ☞ Glas/Metall
- ☞ Blanc/Laiton brossé
- ☞ Verre/Métal
- ☞ Wit/Messing geborsteld
- ☞ Glas/Metaal



**Vala**

max. 20W, E27  
230V  
120 ø110 mm  
EAN 4000870 797426



**797.42**

- ☞ Messing gebürstet/Marmor
- ☞ Metall/Marmor
- ☞ Laiton brossé/Marbre
- ☞ Métal/Marbre
- ☞ Messing geborsteld/Marmer
- ☞ Metaal/Marmer





Perfect match

□ = 409-412

427



### Narve

max. 60 W, E27

230 V

↑ 1.540 ⇄ 525

∅ 535 mm

EAN 4000870 797242

**797.24**

👉 Beige/Schwarz 📦 Stoff/Metall

👉 Beige/Noir 📦 Tissus/Métal

👉 Beige/Zwart 📦 Textiel/Metaal



On/Off

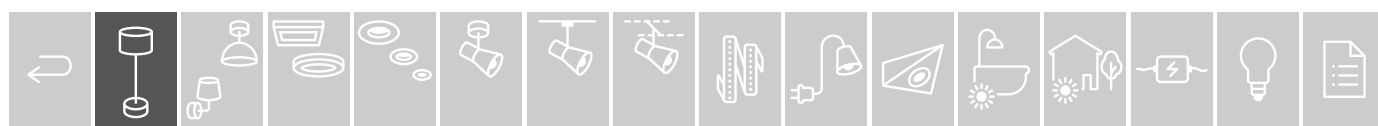



# Real cork / Smoke glass

**Perfect match**  
 = 409-412  
 427



**Iben**  
 max. 20W, E27  
 230V  
 ⚡ 255 ⌀190 mm  
 EAN 4000870 797365  
**797.36**  
 🍷 Rauchglas 📦 Glas/Kork  
 🍷 Verre fumé 📦 Verre/Liège  
 🍷 Rookglas 📦 Glas/Kurk

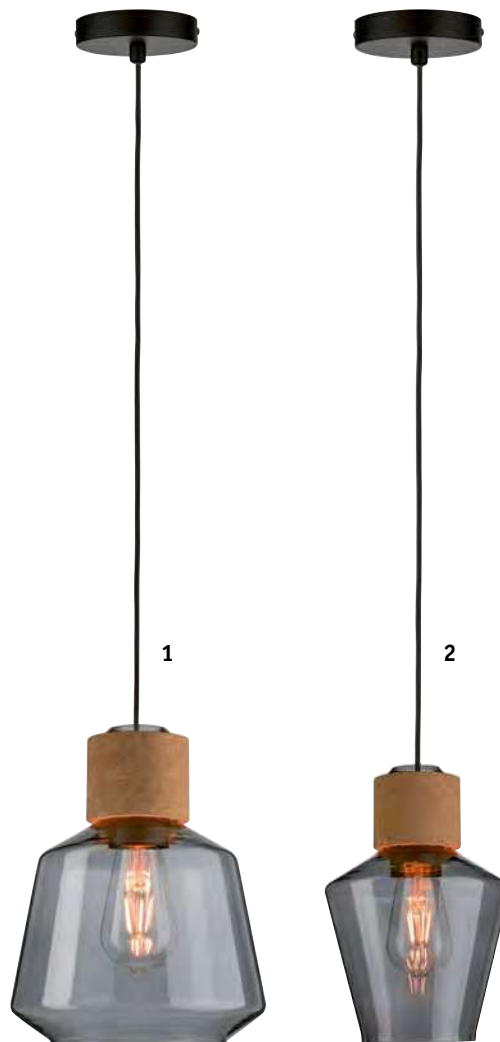

**1 Elia**  
 max. 20W, E27  
 230V  
 ⚡ 110 cm ⌀208 mm  
 EAN 4000870 797396  
**797.39**  
 🍷 Rauchglas/Kork/Schwarz  
 📦 Glas/Kork/Metall  
 🍷 Verre fumé/Liège/Noir  
 📦 Verre/Liège/Métal  
 🍷 Rookglas/Kurk/Zwart 📦 Glas/  
 Kurk/Metaal

**2 Edla**  
 max. 20W, E27  
 230V  
 ⚡ 125 cm ⌀180 mm  
 EAN 4000870 797402  
**797.40**  
 🍷 Rauchglas/Kork/Schwarz  
 📦 Glas/Kork/Metall  
 🍷 Verre fumé/Liège/Noir  
 📦 Verre/Liège/Métal  
 🍷 Rookglas/Kurk/Zwart 📦 Glas/  
 Kurk/Metaal



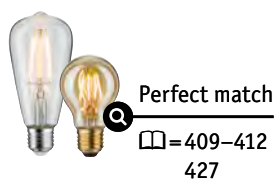

1



2



1 **Liska**

max. 3x20 W, E27  
230 V  
∅150 ∅450 mm  
EAN 4000870 796870  
**796.87**



- 🌿 Holz dunkel 🏠 Holz/Metall
- 🌿 Bois foncé 🏠 Bois/Métal
- 🌿 Hout donker 🏠 Hout/Metaal

2 **Liska**

max. 3x20 W, E27  
230 V  
∅10,2-132 cm  
∅600 mm  
EAN 4000870 796863  
**796.86**



- 🌿 Holz dunkel/Chrom matt 🏠 Holz/Metall
- 🌿 Bois foncé/Chrome mat 🏠 Bois/Métal
- 🌿 Hout donker/Chroom mat 🏠 Hout/Metaal

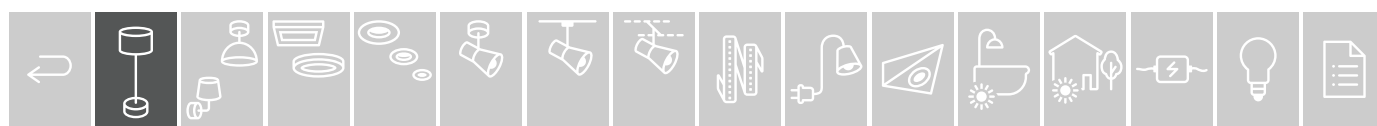

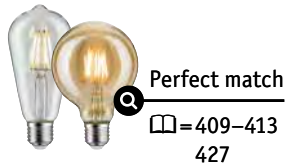

1



2



3



4



5

### 1 Liska

max. 3x20W, E27  
230V  
150 ø450 mm  
EAN 4000870 796504



**796.50**

🔧 Holz 🗺 Holz/Metall  
🔧 Bois 🗺 Bois/Métal  
🔧 Hout 🗺 Hout/Metaal

### 2 Yva

max. 20W, E27  
230V  
23,2-110 cm  
ø240 mm  
EAN 4000870 797440



**797.44**

🔧 Holz/Klar 🗺 Holz/Glas  
🔧 Bois/Clair 🗺 Bois/Verre  
🔧 Hout/Helder 🗺 Hout/Glas

### 3 Ylvie

max. 20W, E27  
230V  
25,7-110 cm ø145 mm  
EAN 4000870 797457



**797.45**

🔧 Holz/Klar 🗺 Holz/Glas  
🔧 Bois/Clair 🗺 Bois/Verre  
🔧 Hout/Helder 🗺 Hout/Glas

### 4 Skadi

max. 20W, E14  
230V  
350 ø110 mm  
EAN 4000870 796641



**796.64**

🔧 Holz/Grau 🗺 Holz/Beton  
🔧 Bois/Gris 🗺 Bois/Béton  
🔧 Hout/Grijs 🗺 Hout/Beton

### 5 Talin

max. 20W, E27  
230V  
130 ø90 mm  
EAN 4000870 796405



**796.40**

🔧 Holz 🗺 Holz  
🔧 Bois 🗺 Bois  
🔧 Hout 🗺 Hout





Perfect match

☐ = 409-412  
427

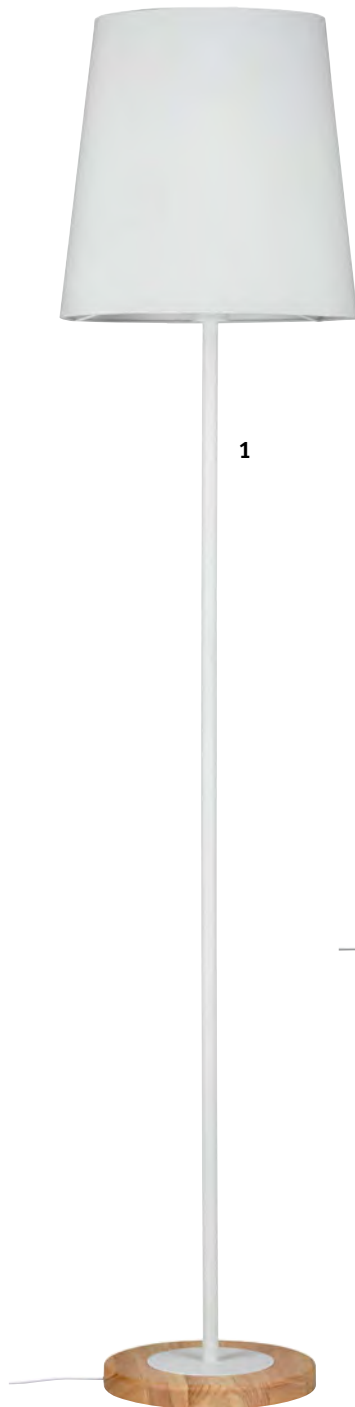

1



2



3

### 1 Stellan

max. 20 W, E27  
230 V  
↑ 1.615 ø 350 mm  
EAN 4000870 796344  
**796.34**

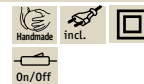

### 2 Stellan

max. 20 W, E27  
230 V  
↑ 400 ø 155 mm  
EAN 4000870 796368  
**796.36**



☞ Weiß/Holz ☐ Stoff/Metall/  
Holz  
☞ Blanc/Bois ☐ Tissus/Métal/  
Bois  
☞ Wit/Hout ☐ Textiel/Metaal/  
Hout

### 3 Berit

max. 20 W, E27  
230 V  
↑ 315 ø 220 mm  
EAN 4000870 796467  
**796.46**



☞ Weiß/Holz ☐ Stoff/Holz/  
Metall  
☞ Blanc/Bois ☐ Tissus/Bois/  
Métal  
☞ Wit/Hout ☐ Textiel/Hout/  
Metaal





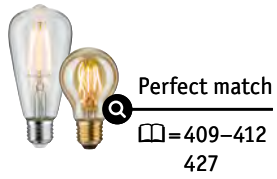

☐ = 409-412  
427

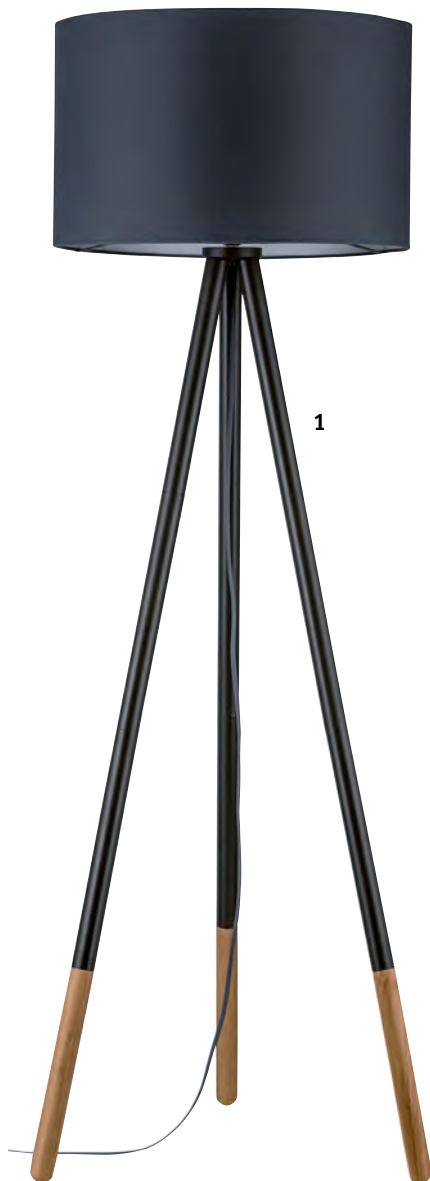
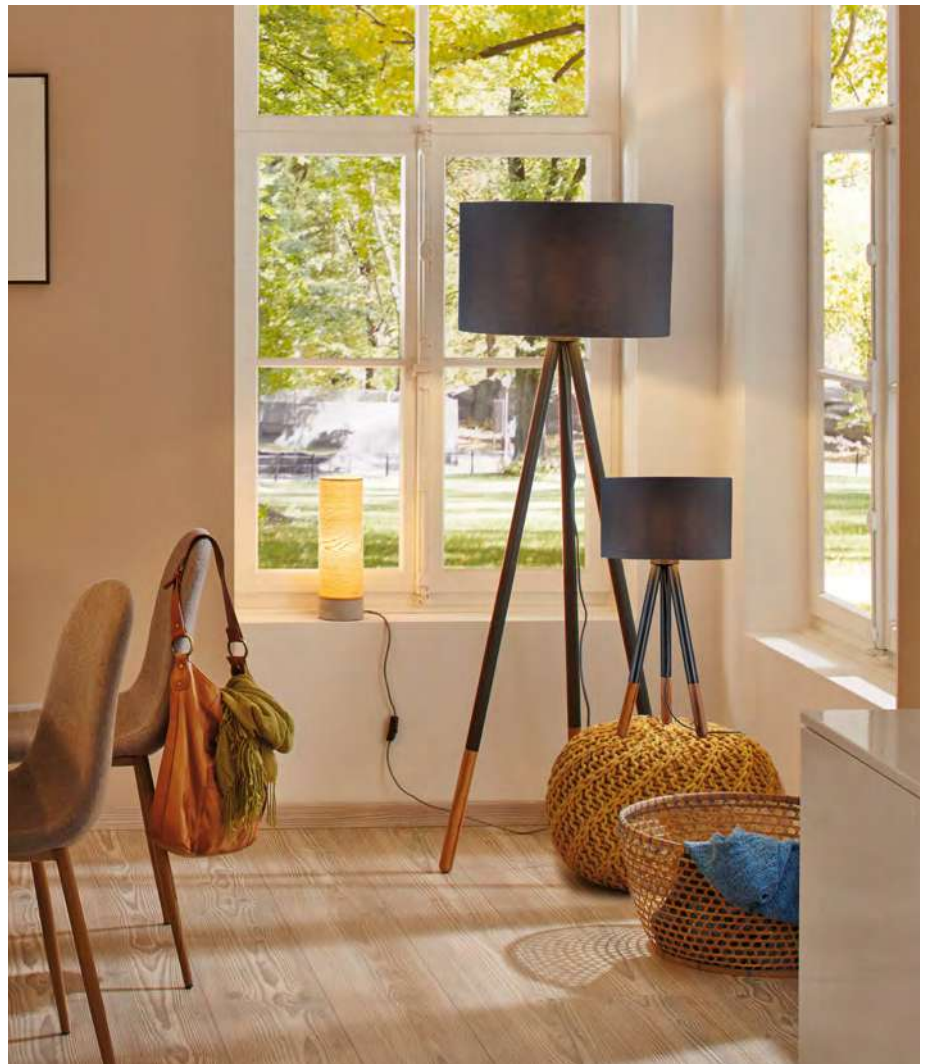

**1 Rurik**

max. 20W, E27  
230V  
↑1.530 ø538 mm  
EAN 4000870 796337  
**796.33**



**2 Rurik**

max. 20W, E27  
230V  
↑700 ø250 mm  
EAN 4000870 796351  
**796.35**



☞ Gris/Holz ☐ Stoff/Metall/  
Holz  
☞ Gris/Bois ☐ Tissus/Métal/Bois  
☞ Grijs/Hout ☐ Textiel/Metaal/  
Hout



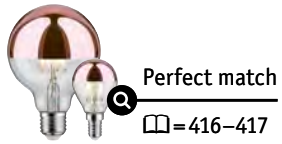

**1 Juna**  
max. 20W, E14  
230V  
⌀110 cm ø160 mm  
EAN 4000870 796528  
**796.52**

**2 Juna**  
max. 3×20W, E14  
230V  
⌀170 cm ø460 mm  
EAN 4000870 796535  
**796.53**

**3 Juna**  
max. 20W, E27  
230V  
⌀110 cm ø342 mm  
EAN 4000870 796559  
**796.55**

**4 Juna**  
max. 20W, E14  
230V  
⌀1.580 ⇄230  
⌀400 mm  
EAN 4000870 796542  
**796.54**

**5 Juna**  
max. 20W, E14  
230V  
⌀510 ⇄180  
⌀255 mm  
EAN 4000870 796511  
**796.51**

☞ Softgrün/Kupfer/Holz  
☞ Metall/Holz  
☞ Vert satiné/Cuivre/Bois  
☞ Métal/Bois  
☞ Softgroen/Koper/Hout  
☞ Metaal/Hout

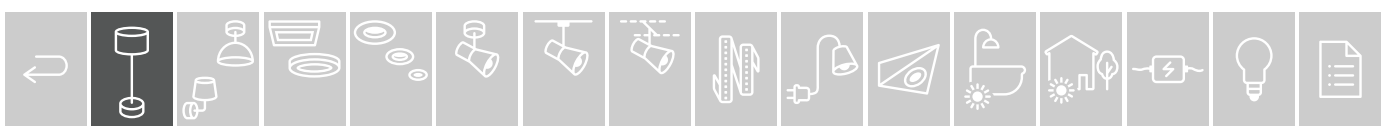
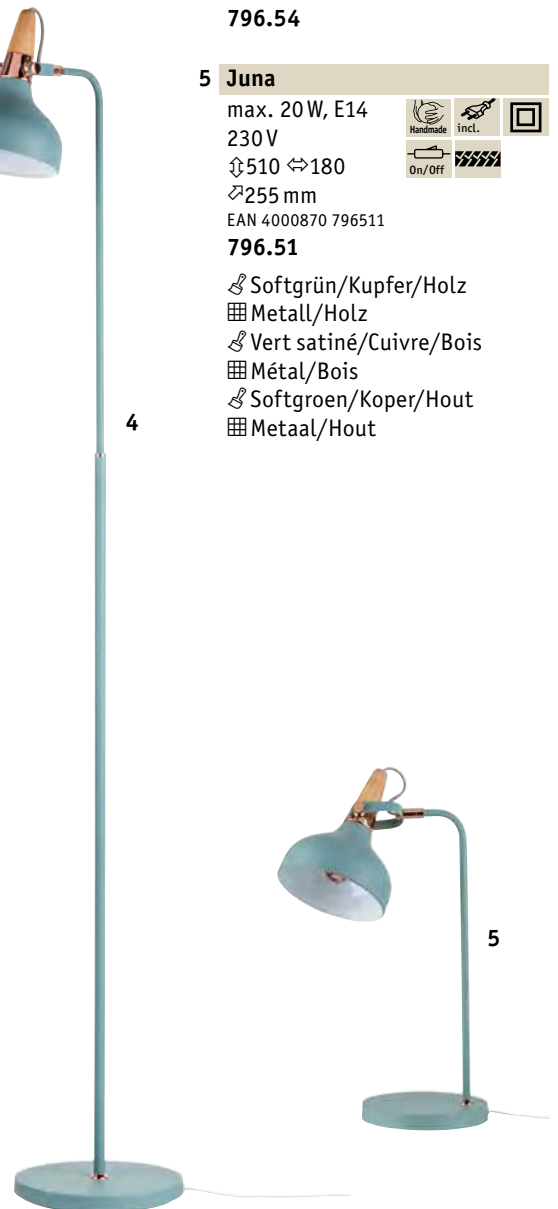



**1 Embla**

max. 20W, E27  
230V  
∅110 cm ø300 mm  
EAN 4000870 796283



**796.28**

↳ Weiß matt/Gold Metall  
↳ Blanc dépoli/Doré Métal  
↳ Wit mat/Goud Metaal

**2 Embla**

max. 20W, E27  
230V  
∅110 cm ø300 mm  
EAN 4000870 796290



**796.29**

↳ Schwarz/Kupfer matt Metall  
↳ Noir/Cuivre Dépoli Métal  
↳ Zwart/Koper mat Metaal

**3 Haldis**

max. 20W, E27  
230V  
∅200 cm ø100 mm  
EAN 4000870 503874



**503.87**

↳ Kupfer Metall  
↳ Cuivre Métal  
↳ Koper Metaal

**4 Vanja**

max. 20W, E27  
230V  
∅110 cm ø200 mm  
EAN 4000870 796443



**796.44**

↳ Weiß matt/Klar Glas/Metall  
↳ Blanc dépoli/Clair Verre/Métal  
↳ Wit mat/Helder Glas/Metaal





Perfect match

☐ = 416-417



2

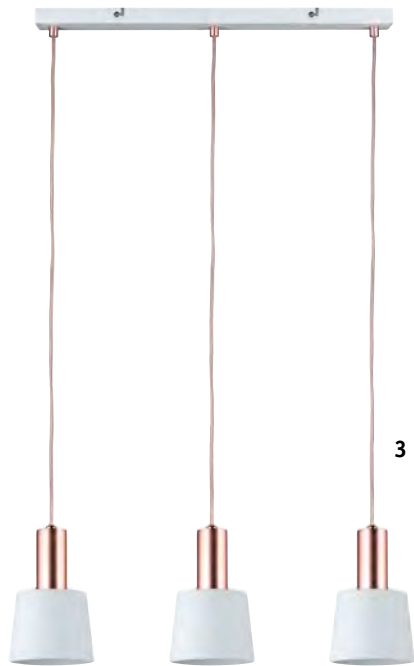

3



1



4



**1 Haldar**

max. 2×20 W, E14  
230 V  
⌈1.520 ⇄300  
∅230 mm  
EAN 4000870 796603  
**796.60**



**2 Haldar**

max. 20 W, E14  
230 V  
⌈110 cm ∅120 mm  
EAN 4000870 796566  
**796.56**

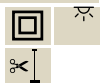

**3 Haldar**

max. 3×20 W, E14  
230 V  
⌈142 cm ∅120 mm  
⇄550 mm  
EAN 4000870 796573  
**796.57**

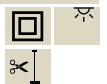

**4 Haldar**

max. 20 W, E14  
230 V  
⌈460 ∅160 mm  
EAN 4000870 796580  
**796.58**



☞ Weiß/Kupfer matt ☐ Metall  
☞ Blanc/Cuivre Dépoli ☐ Métal  
☞ Wit/Koper mat ☐ Metaal





**1 Haldar**  
 max. 2x20 W, E14  
 230 V  
 ⚡1.520 ⇄300  
 ⌀230 mm  
 EAN 4000870 796900  
**796.90**



**2 Haldar**  
 max. 20 W, E14  
 230 V  
 ⚡110 cm ø120 mm  
 EAN 4000870 796917  
**796.91**



👉 Dunkelgrau/Chrom matt  
 🏠 Metall  
 👉 Gris foncé/Chrome mat  
 🏠 Métal  
 👉 Donkergrijs/Chroom mat  
 🏠 Metaal



**3 Thala**  
 max. 20 W, E14  
 230 V  
 ⚡1.410 ø300 mm  
 EAN 4000870 796825  
**796.82**



👉 Grau 🏠 Metall  
 👉 Gris 🏠 Métal  
 👉 Grijs 🏠 Metaal

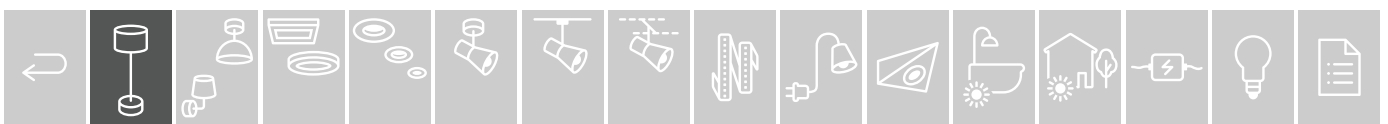



Perfect match

☐ = 409-423  
427-430



**1 Ketil**

max. 20W, E27  
230 V  
↑200 cm ø92 mm  
EAN 4000870 503836

**503.83**

- ☞ Weiß ☐ Silikon/Kunststoff
- ☞ Blanc ☐ Silicone/Matière plastique
- ☞ Wit ☐ Silicon/Kunststof

**2 Ketil**

max. 20W, E27  
230 V  
↑200 cm ø92 mm  
EAN 4000870 503812

**503.81**

- ☞ Schwarz ☐ Silikon/Kunststoff
- ☞ Noir ☐ Silicone/Matière plastique
- ☞ Zwart ☐ Silicon/Kunststof

**3 Ketil**

max. 3×20W, E27  
230 V  
↑200 cm ø100 mm  
EAN 4000870 503829

**503.82**

- ☞ Schwarz ☐ Silikon/Metall
- ☞ Noir ☐ Silicone/Métal
- ☞ Zwart ☐ Silicon/Metaal





Perfect match  
 □ = 409-423  
 427-430



**1 Ketil**  
 max. 5x20 W, E27  
 230 V  
 ⚙ 200 cm ø150 mm  
 EAN 4000870 503898  
**503.89** 📄

**2 Ketil**  
 max. 7x20 W, E27  
 230 V  
 ⚙ 200 cm ø150 mm  
 EAN 4000870 503904  
**503.90** 📄

🔗 Schwarz 📄 Silikon/Metall  
 🔗 Noir 📄 Silicone/Métal  
 🔗 Zwart 📄 Silicon/Metaal





**1 Eldar**  
 max. 20W, E27  
 230V  
 ⚡ 500 cm ø40 mm  
 EAN 4000870 797709  
**797.70** 📦 **new**  
 🌀 Rot/Nickel gebürstet 📦 Metall  
 🌀 Rouge/Nickel brossé 📦 Métal  
 🌀 Rood/Nikkel geborsteld  
 📦 Metaal

**2 Eldar**  
 max. 20W, E27  
 230V  
 ⚡ 500 cm ø40 mm  
 EAN 4000870 797716  
**797.71** 📦 **new**  
 🌀 Grau/Nickel 📦 Metall  
 🌀 Gris/Nickel 📦 Métal  
 🌀 Grijs/Nikkel 📦 Metaal

**3 Eldar**  
 max. 20W, E27  
 230V  
 ⚡ 200 cm ø100 mm  
 EAN 4000870 503867  
**503.86** 📦  
 🌀 Rot/Nickel gebürstet 📦 Metall  
 🌀 Rouge/Nickel brossé 📦 Métal  
 🌀 Rood/Nikkel geborsteld  
 📦 Metaal

**4 Eldar**  
 max. 20W, E27  
 230V  
 ⚡ 200 cm ø100 mm  
 EAN 4000870 503850  
**503.85** 📦  
 🌀 Grau/Nickel 📦 Metall  
 🌀 Gris/Nickel 📦 Métal  
 🌀 Grijs/Nikkel 📦 Metaal

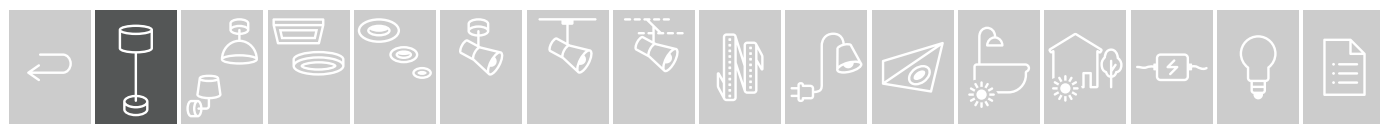



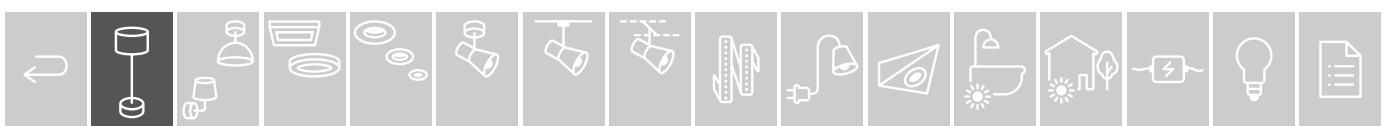

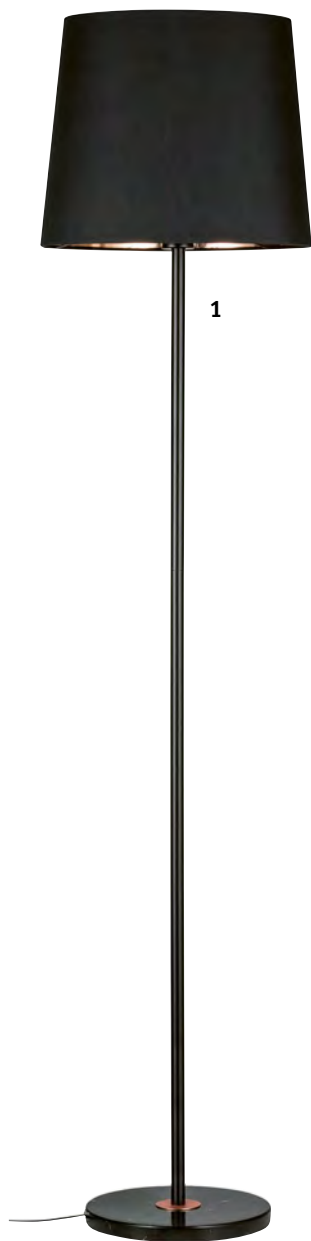

1

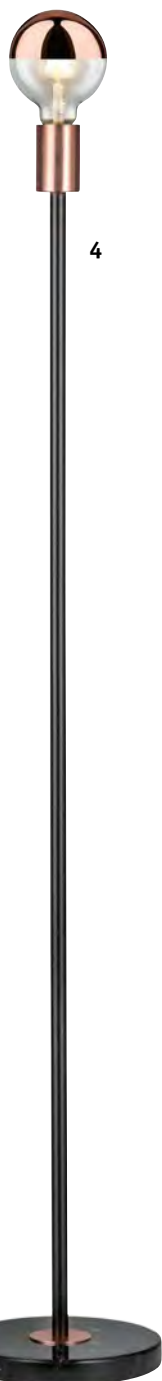

4

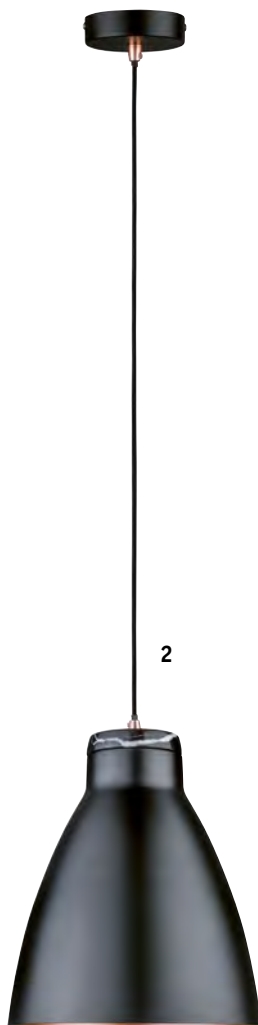

2



3



5

**1 Enja**

max. 20W, E27  
230V  
1.600 ø360 mm  
EAN 4000870 796122



**796.12**

Schwarz/Kupfer Stoff/Marmor/Metall  
Noir/Cuivre Tissus/Marbre/Métal  
Zwart/Koper Textiel/Marmer/Metaal

**2 Roald**

max. 20W, E27  
230V  
110 cm  
ø260 mm  
EAN 4000870 796092



**796.09**

Schwarz matt/Kupfer matt Metall/Marmor  
Noir mat/Cuivre Dépoli Métal/Marbre  
Zwart mat/Koper mat Metaal/Marmer

**3 Nordin**

max. 20W, E27  
230V  
190 cm  
ø100 mm  
EAN 4000870 797518



**797.51**

Schwarz/Marmor/Kupfer matt Marmor  
Noir/Marbre/Cuivre Dépoli Marbre  
Zwart/Marmer/Koper mat Marmer

**4 Nordin**

max. 20W, E27  
230V  
1.200 ø200 mm  
EAN 4000870 796146



**796.14**

Schwarz/Kupfer matt Marmor/Metall  
Noir/Cuivre Dépoli Marbre/Métal  
Zwart/Koper mat Marmer/Metaal

**5 Nordin**

max. 20W, E27  
230V  
130 ø95 mm  
EAN 4000870 796009



**796.00**

Schwarz Marmor  
Noir Marbre  
Zwart Marmer

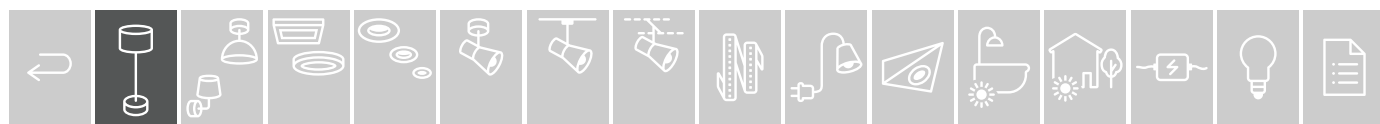

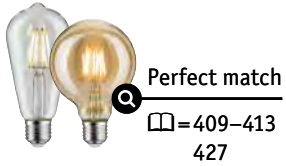

**1 Nordin**

max. 20 W, E27  
230 V  
190 cm  
100 mm  
EAN 4000870 797501



**797.50**  
 Weiß/Marmor/Gold matt  
 Marmor  
 Blanc/Marbre/Doré mat  
 Marbre  
 Wit/Marmer/Goud mat  
 Marmer

**2 Nordin**

max. 20 W, E27  
230 V  
1.200 200 mm  
EAN 4000870 796153



**796.15**  
 Weiß/Gold matt Marmor/  
 Metall  
 Blanc/Doré mat Marbre/  
 Métal  
 Wit/Goud mat Marmer/  
 Metaal

**3 Nordin**

max. 20 W, E27  
230 V  
130 95 mm  
EAN 4000870 796016



**796.01**  
 Weiß Marmor  
 Blanc Marbre  
 Wit Marmer

**4 Moa**

max. 10 W, G9  
230 V  
400 100 mm  
EAN 4000870 796610



**796.61**  
 Weiß/Gold matt Glas/  
 Marmor/Metall  
 Blanc/Doré mat Verre/  
 Marbre/Métal  
 Wit/Goud mat Glas/  
 Marmer/Metaal



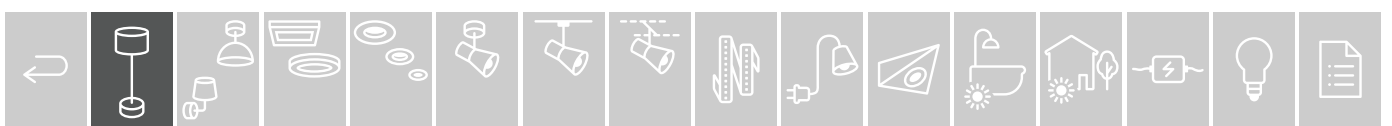



1



2



3



4

### 1 Henja

max. 20W, E27  
230V

↑ 110 cm ø120 mm

EAN 4000870 796184

**796.18**

↳ Grau/Eisen gebürstet

▣ Beton/Metall

↳ Gris/Acier brossé ▣ Béton/Métal

↳ Grijs/Staal geborsteld

▣ Beton/Metaal



### 2 Helin

max. 20W, E27  
230V

↑ 110 cm ø190 mm

EAN 4000870 796160

**796.16**

↳ Grau/Satin ▣ Beton/Glas

↳ Gris/Satiné ▣ Béton/Verre

↳ Grijs/Satijn ▣ Beton/Glas



### 3 Jano

max. 20W, E27  
230V

↑ 200 cm ø110 mm

EAN 4000870 503881

**503.88**

↳ Grau/Schwarz ▣ Beton/Kunststoff

↳ Gris/Noir ▣ Béton/Matière plastique

↳ Grijs/Zwart ▣ Beton/Kunststof



### 4 Mik

max. 20W, E27  
230V

↑ 130 ø90 mm

EAN 4000870 796214

**796.21**

↳ Grau ▣ Beton

↳ Gris ▣ Béton

↳ Grijs ▣ Beton





### 1 Stig

max. 20 W, E27  
230 V

↑ 110 cm ø120 mm

EAN 4000870 796177

**796.17**

↳ Grau/Kupfer matt Beton/  
Metall

↳ Gris/Cuivre Dépoli Béton/  
Métal

↳ Grijs/Koper mat Beton/  
Metaal



### 2 Stig

max. 3×20 W, E27  
230 V

↑ 110 cm

↔ 600 ↗ 100 mm

EAN 4000870 796269

**796.26**

↳ Grau/Kupfer matt Beton/  
Metall

↳ Gris/Cuivre Dépoli Béton/  
Métal

↳ Grijs/Koper mat Beton/  
Metaal



### 3 Ingram

max. 20 W, E27  
230 V

↑ 215 ø230 mm

EAN 4000870 796634

**796.63**

↳ Grau Beton

↳ Gris Béton

↳ Grijs Beton

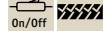

### 4 Tem

max. 20 W, E27  
230 V

↑ 340 ø220 mm

EAN 4000870 796221

**796.22**

↳ Grau/Kupfer Stoff/Beton/  
Metall

↳ Gris/Cuivre Tissus/Béton/  
Métal

↳ Grijs/Koper Textiel/Beton/  
Metaal





**1 Oda**

max. 20W, E27  
230V  
137 cm ø250 mm  
EAN 4000870 796252



**796.25**

Wei matt/Kupfer matt/Grau  
Metall/Beton  
Blanc dpoli/Cuivre Dpoli/  
Gris Mtal/Bton  
Wit mat/Koper mat/Grijs  
Metaal/Beton

**2 Orm**

max. 20W, E27  
230V  
500 ø150 mm  
EAN 4000870 796245



**796.24**

Grau/Kupfer matt Metall/  
Beton  
Gris/Cuivre Dpoli Mtal/  
Bton  
Grijs/Koper mat Metaal/  
Beton

**3 Yorik**

max. 20W, E27  
230V  
350 ø200 mm  
EAN 4000870 796658



**796.65**

Klar/Grau/Kupfer Glas/  
Beton/Metall  
Clair/Gris/Cuivre Verre/  
Bton/Mtal  
Helder/Grijs/Koper Glas/  
Beton/Metaal

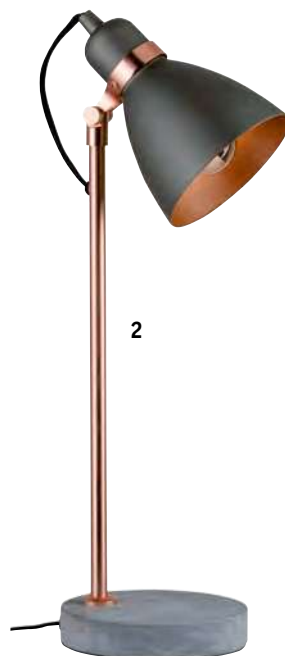
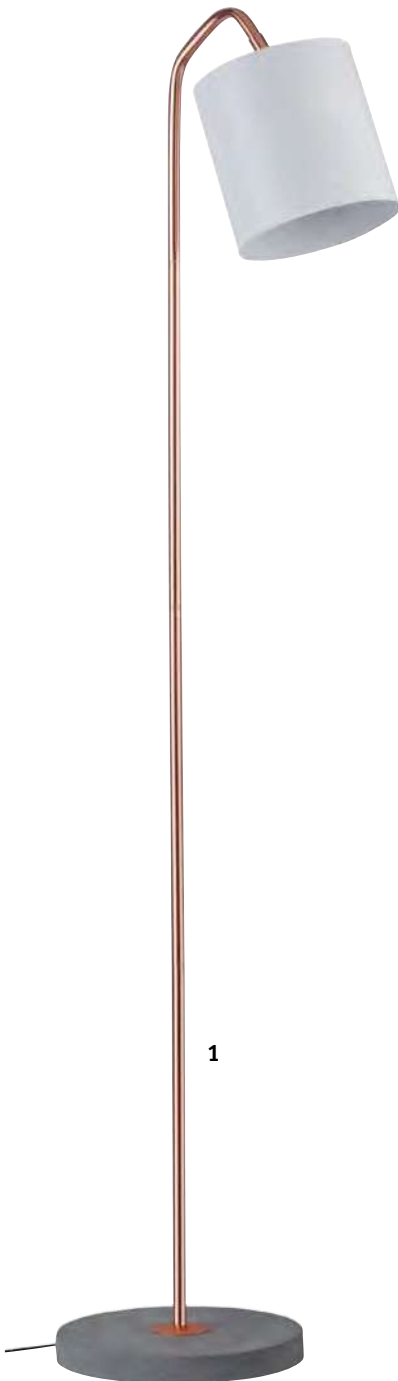

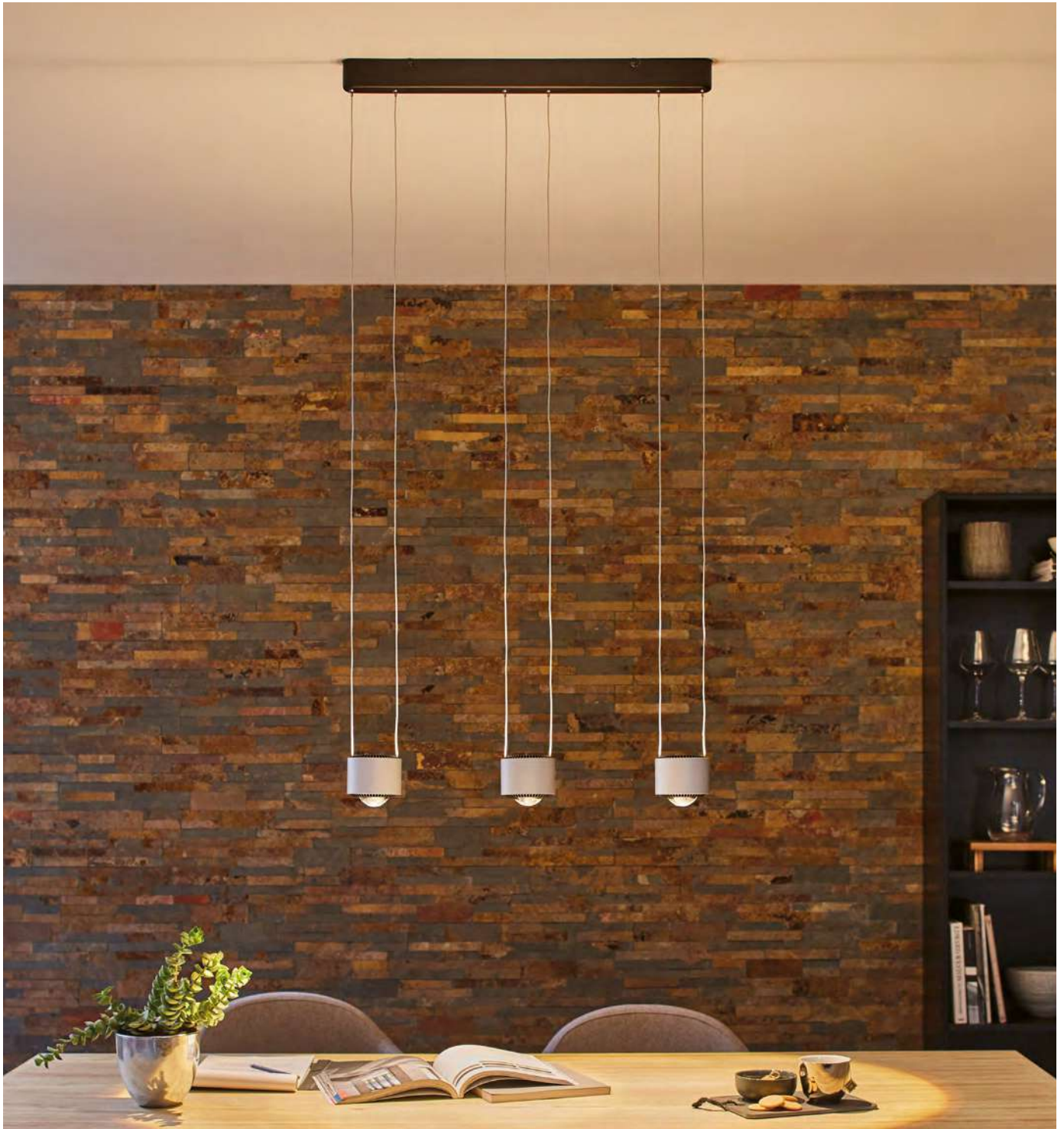

excl. Diffusor

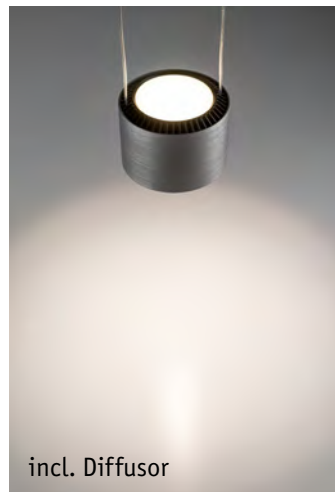

incl. Diffusor

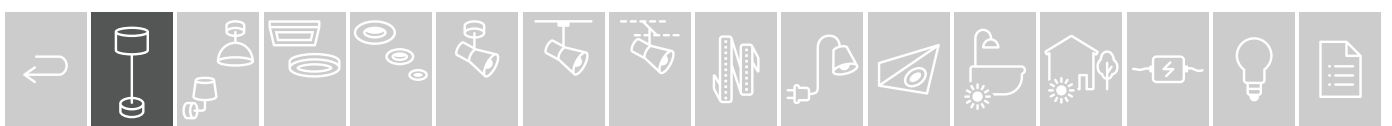





**1 Aldan**

incl. 1×4,6 /  
1×8,3 W  
635 + 910 lm,  
2.700 K  
230 V  
∅1.120-1.570 ∅275 mm  
EAN 4000870 797174  
**797.17**



**2 Aldan II**

incl. 1×10,7 W  
840 + 450 lm  
230 V  
∅85 mm ∅17,4-150 cm  
∅100 mm  
EAN 4000870 797860  
**797.86 new**



**3 Aldan**

incl. 3×4,8 / 3×4,4 W  
3×635 + 388 lm, 2.700 K  
230 V  
∅85 mm ∅8,9-150 cm  
∅100 mm ∅670 mm  
EAN 4000870 797204  
**797.20**

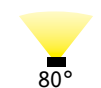
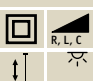

**4 Aldan**

incl. 1×4 W  
400 lm, 2.700 K  
∠ 80°  
230 V  
∅100 ∅100 mm  
EAN 4000870 797181  
**797.18**



🔧 Schwarz/Alu gebürstet  
🔧 Aluminium  
🔧 Noir/Alu brossé 🔧 Aluminium  
🔧 Zwart/Alu geborsteld  
🔧 Aluminium



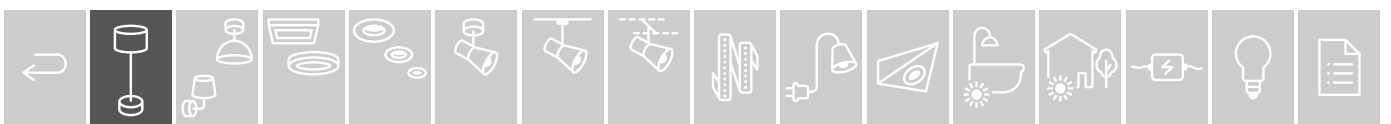

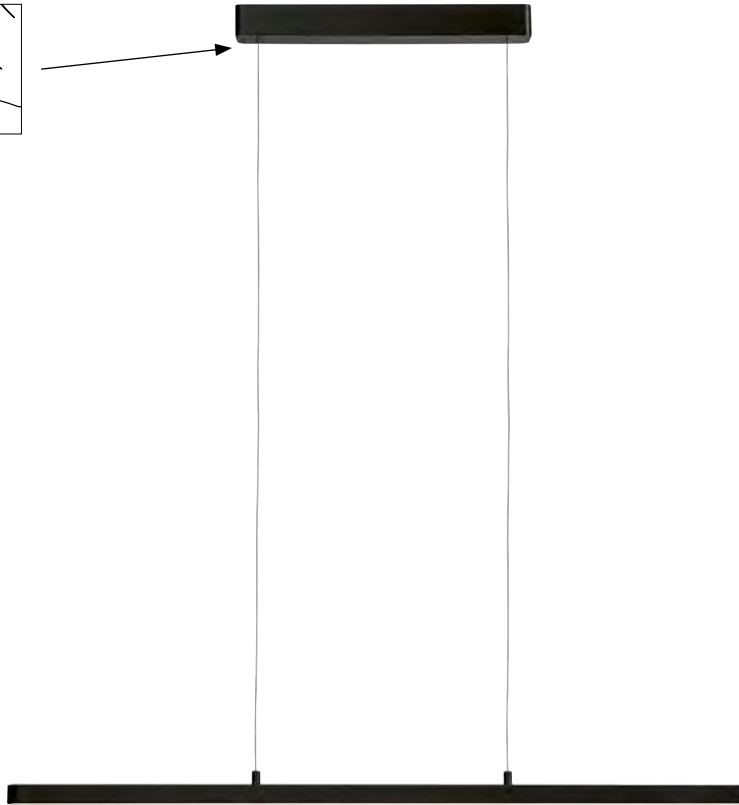
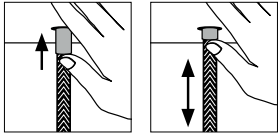

**Lento**

incl. 1x37 W  
 3.495 lm, 2.700 K  
 230 V  
 ⌀25 mm ⌀6,7-150 cm  
 ⇄1.000 mm ↗35 mm  
 EAN 4000870 796931

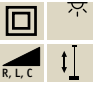

**796.93**

↳ Schwarz ▣ Aluminium/  
 Kunststoff  
 ↳ Noir ▣ Aluminium/  
 Matière plastique  
 ↳ Zwart ▣ Aluminium/Kunststof

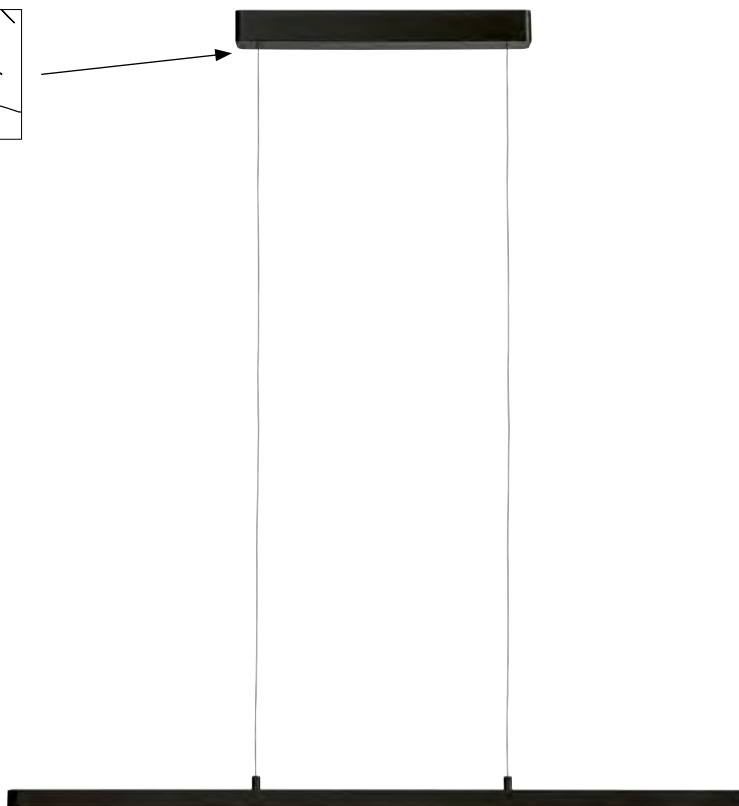
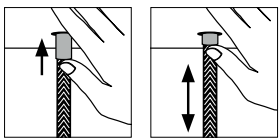

**Lento**

incl. 1x40,5 W  
 3.570 lm, 2.700 -  
 6.500 K  
 230 V  
 ⌀25 mm ⌀6,7-150 cm  
 ⇄1.000 mm ↗35 mm  
 EAN 4000870 796948



**796.94**

↳ Schwarz ▣ Aluminium/  
 Kunststoff  
 ↳ Noir ▣ Aluminium/  
 Matière plastique  
 ↳ Zwart ▣ Aluminium/Kunststof



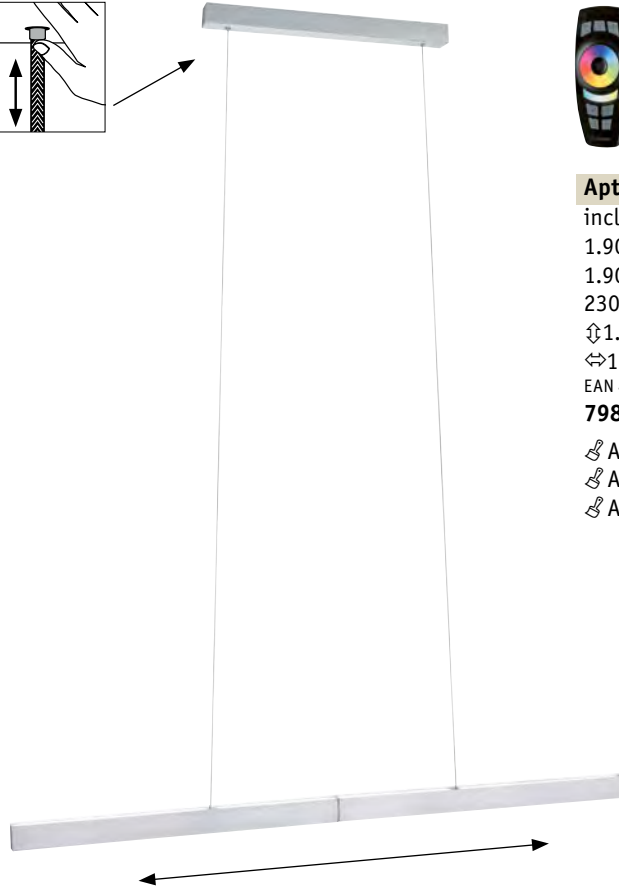
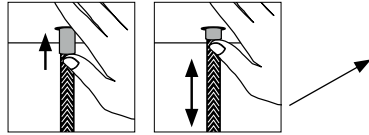

incl.



**Aptare**

incl. 1x18 W

1.900 +

1.900 lm, 2.700 K

230 V

⌀1.500 mm ⌀90-150 cm

⇄1.800 mm ↻50 mm

EAN 4000870 798157

**798.15**

Alu gebürstet Metall

Alu brossé Métal

Alu geborsteld Metaal

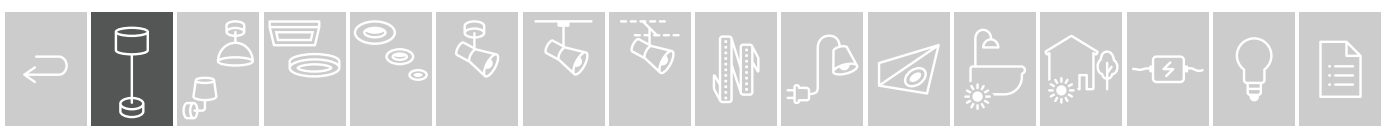
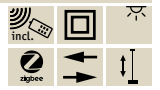

**Belaja**

incl. 1×24 W

2.850 lm, 2.700 K

230 V

↕1.480 ø425

↔448 mm

EAN 4000870 797211

**797.21**

👉 Weiß/Chrome matt 🏠 Metall

👉 Blanc/Chrome mat 🏠 Métal

👉 Wit/Chroom mat 🏠 Metaal

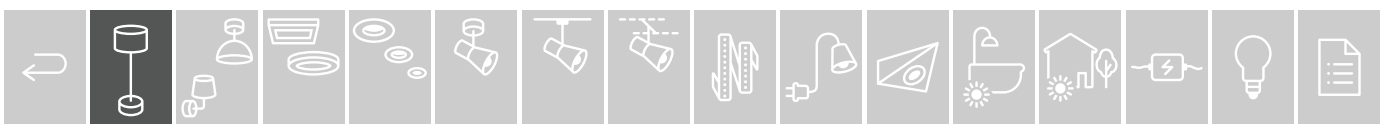

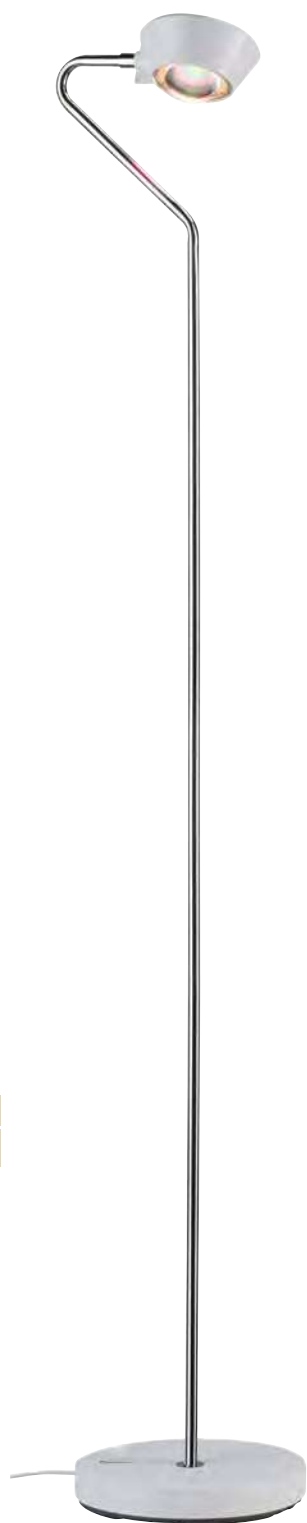

**Ramos**

incl. 1x7,5 /

1x3,5 W

813 + 303 lm,

3.000 K

230 V

∅1.415 ∅226 mm

EAN 4000870 709207

**709.20**

☞ Weiß matt/Chrom

☒ Kunststoff/Metall

☞ Blanc dépoli/Chrome

☒ Matière plastique/Métal

☞ Wit mat/Chroom

☒ Kunststof/Metaal

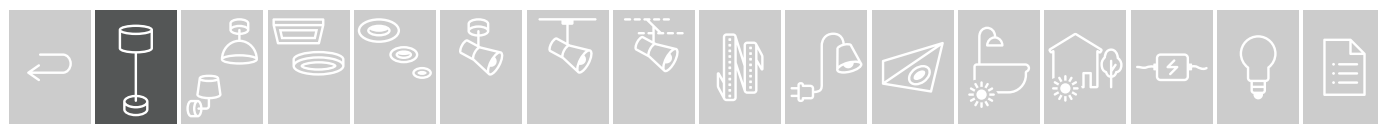



**1 Sabik**

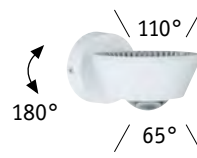

incl. 1x9 / 1x4,5 W  
840 + 320 lm, 2.700 K  
230 V



∅80 ⇔117 ∅152 mm  
EAN 4000870 709467

**709.46**

- ↳ Weiß matt ▣ Kunststoff
- ↳ Blanc dépoli
- ↳ Matière plastique
- ↳ Wit mat ▣ Kunststof

**2 Sabik**

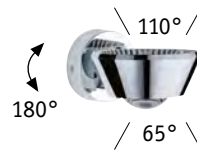

incl. 1x9 / 1x4,5 W  
840 + 320 lm, 2.700 K  
230 V



∅80 ⇔117 ∅152 mm  
EAN 4000870 709474

**709.47**

- ↳ Chrom ▣ Kunststoff
- ↳ Chrome ▣ Matière plastique
- ↳ Chroom ▣ Kunststof

**3 Sabik**



incl. 1x9 / 1x4 W  
840 + 320 lm, 2.700 K  
230 V



∅80 ⇔117 ∅152 mm  
EAN 4000870 797693

**797.69 new**

- ↳ Schwarz ▣ Kunststoff
- ↳ Noir ▣ Matière plastique
- ↳ Zwart ▣ Kunststof



incl. dichroic foil

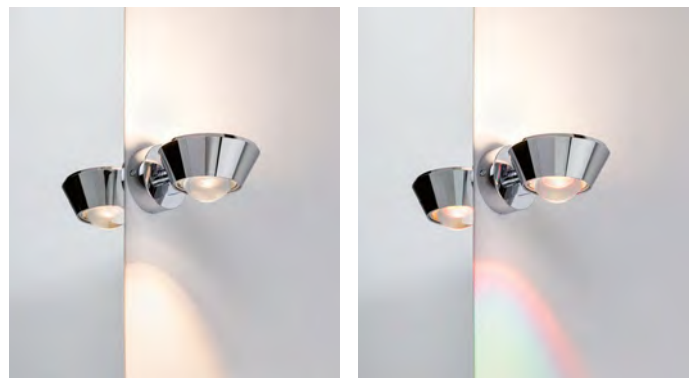

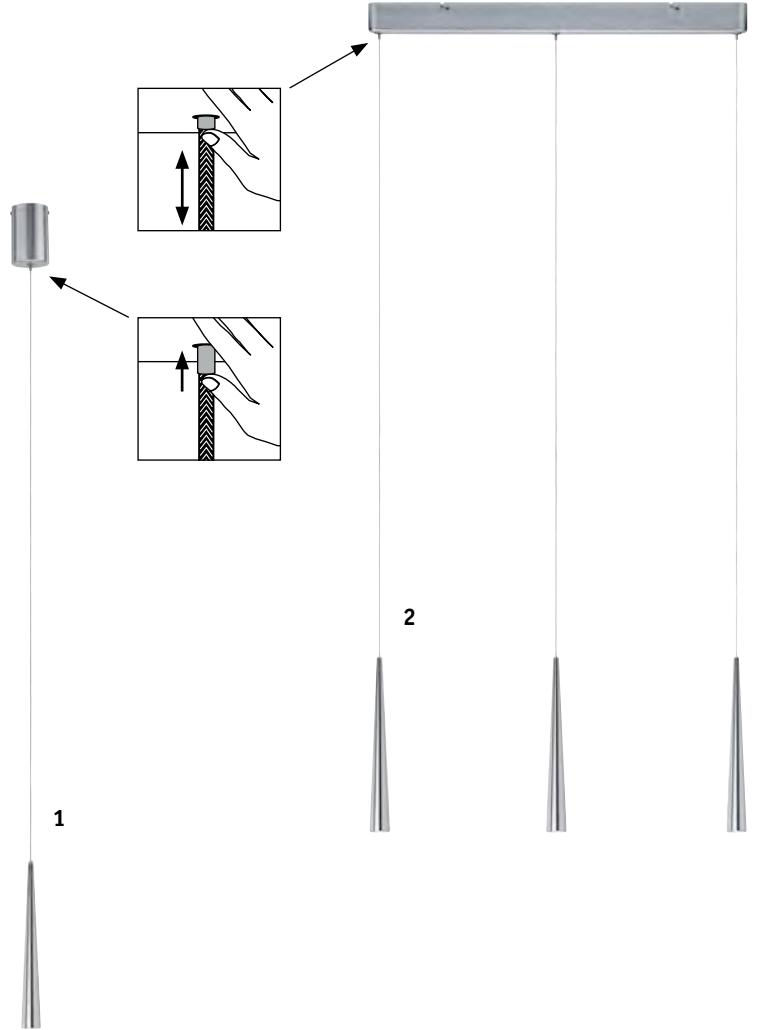

**1 Gutta**

incl. 1×6,4 W  
600 lm, 2.700 K  
230 V  
∅40,1-150 cm ∅72 mm  
EAN 4000870 709290  
**709.29**

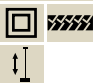

**2 Gutta**

incl. 3×6,4 W  
3×580 + 0 lm, 2.700 K  
230 V  
∅40,1-150 cm ∅33 mm  
⇄670 mm ∅36 mm  
EAN 4000870 709306  
**709.30**

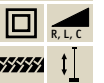

- 🔧 Alu gebürstet 🏠 Metall
- 🔧 Alu brossé 🏠 Métal
- 🔧 Alu geborsteld 🏠 Metaal





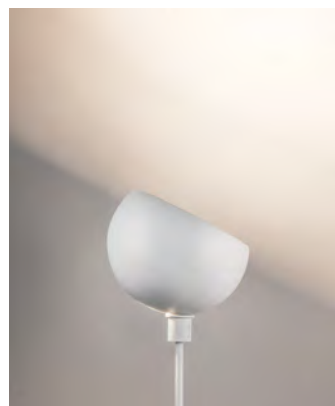
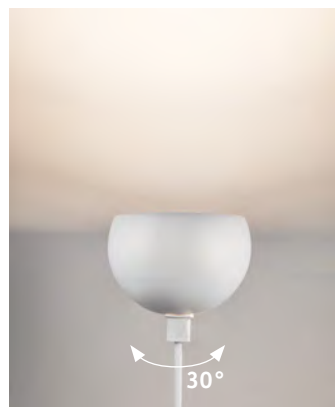

**Gambia**

max. 60W, E27  
 230V  
 ∅1.522 ∅300 mm  
 EAN 4000870 709283  
**709.28**  
 • Weiß matt ■ Metall  
 • Blanc dépoli ■ Métal  
 • Wit mat ■ Metaal

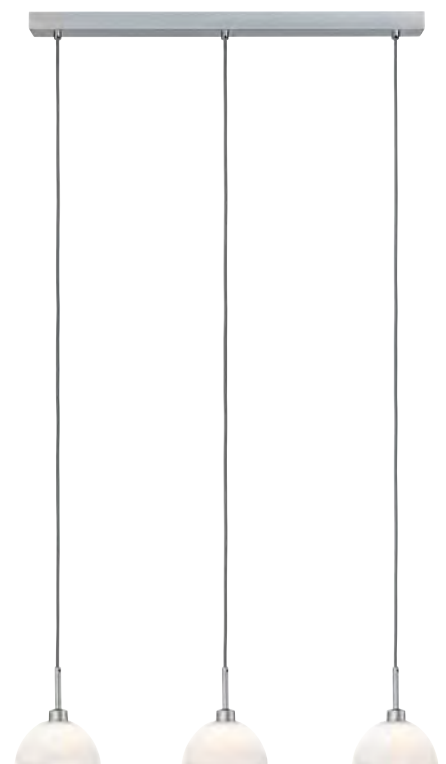

**Parana**

max. 3x40W, GU10  
 230V  
 ∅110 cm ∅690 mm  
 EAN 4000870 709252  
**709.25**

• Weiß/Chrom matt ■ Glas/  
 Metall  
 • Blanc/Chrome mat ■ Verre/  
 Métal  
 • Wit/Chroom mat ■ Glas/  
 Metaal

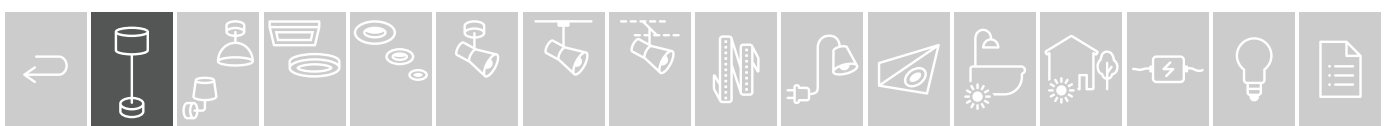
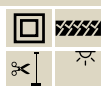



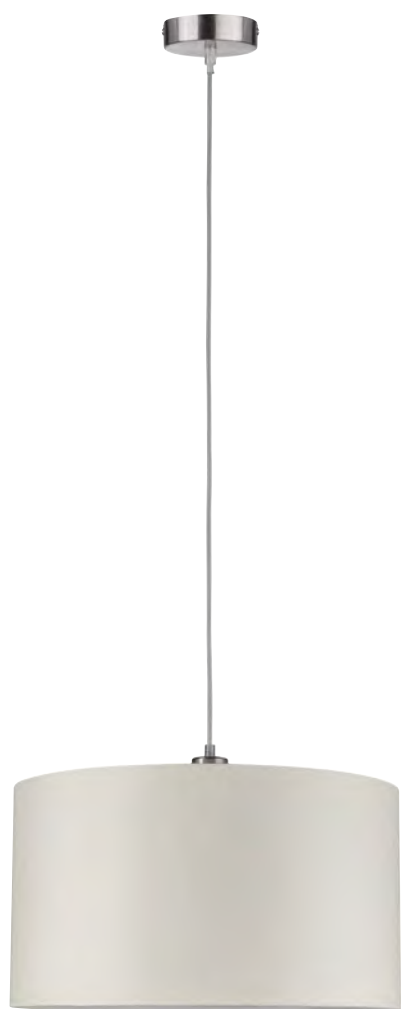

1

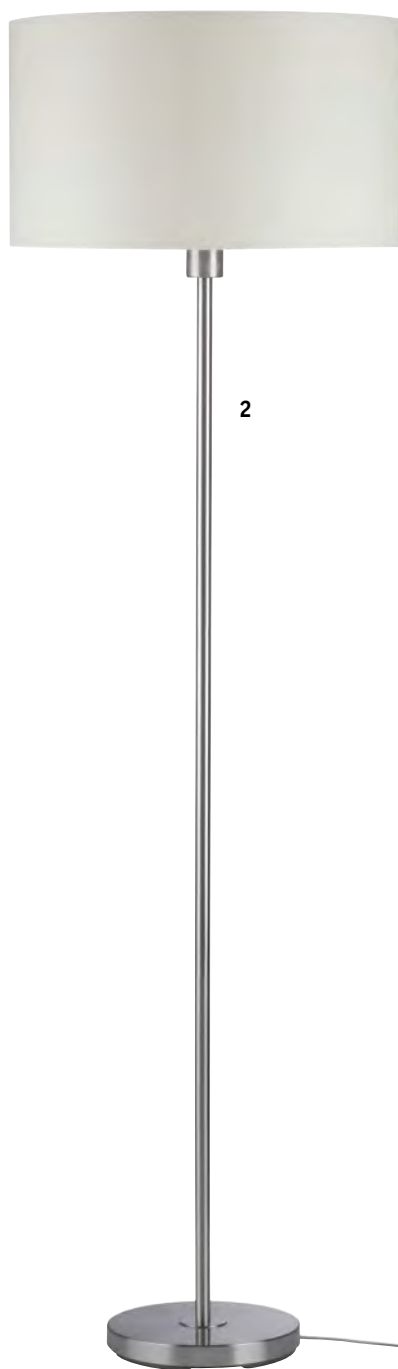

2



3

**1 Tessa**

max. 60W, E27  
230V  
⌄110 cm ø450 mm  
EAN 4000870 709245  
**709.24**



**2 Tessa**

max. 60W, E27  
230V  
⌄1.600 ø450 mm  
EAN 4000870 709221  
**709.22**



**3 Tessa**

max. 40W, E14  
230V  
⌄450 ø250 mm  
EAN 4000870 709238  
**709.23**



- ☞ Creme/Eisen gebürstet
- ☞ Metall/Stoff
- ☞ Crème/Acier brossé
- ☞ Métal/Tissus
- ☞ Crème/Staal geborsteld
- ☞ Metaal/Textiel



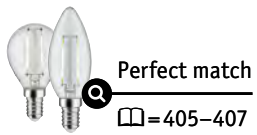

1



2



3



**1 Noora**

max. 42 W, E14  
230 V  
∅210 ø80 mm  
EAN 4000870 770108

**770.10**

- Opal Glas
- Opale Verre
- Opaal Glas

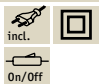

**2 Pia**

max. 25 W, E14  
230 V  
∅210 ø100 mm  
EAN 4000870 770580

**770.58**

- Wei/Eisen gebrstet
- Metall/Stoff
- Blanc/Acier bross
- Mtal/Tissus
- Wit/Staal geborsteld
- Metaal/Textiel

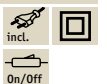

**3 Pia**

max. 25 W, E14  
230 V  
∅210 ø100 mm  
EAN 4000870 770597

**770.59**

- Schwarz matt Metall/Stoff
- Noir mat Mtal/Tissus
- Zwart mat Metaal/Textiel

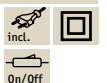



3 step dimmable

only with 287.38, 287.39



1



2



3

**1 Pinja**

max. 20 W, E14

230 V

⌀244 ø110 mm

EAN 4000870 770559

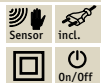
**770.55**

☞ Weiß/Messing gebürstet

☒ Metall/Glas

☞ Blanc/Laiton brossé ☒ Métal/Verre

☞ Wit/Messing geborsteld

☒ Metaal/Glas

**2 Pinja**

max. 20 W, E14

230 V

⌀244 ø110 mm

EAN 4000870 770566

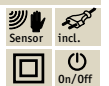
**770.56**

☞ Chrom/Rauchglas ☒ Metall/Glas

☞ Chrome/Verre fumé ☒ Métal/Verre

☞ Chroom/Rookglas ☒ Metaal/Glas

**3 Aari**

max. 20 W, E14

230 V

⌀240 ø200 mm

EAN 4000870 770573

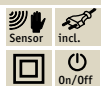
**770.57**

☞ Chrom/Opal ☒ Metall/Glas

☞ Chrome/Opale ☒ Métal/Verre

☞ Chroom/Opaal ☒ Metaal/Glas



# Wall & Ceiling

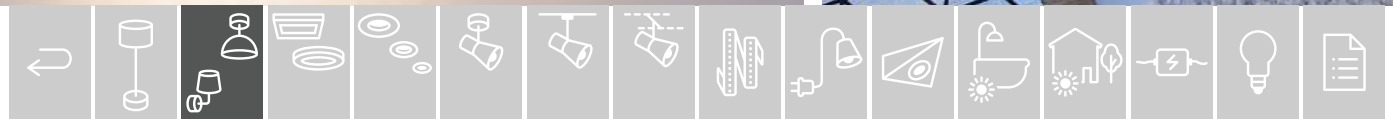
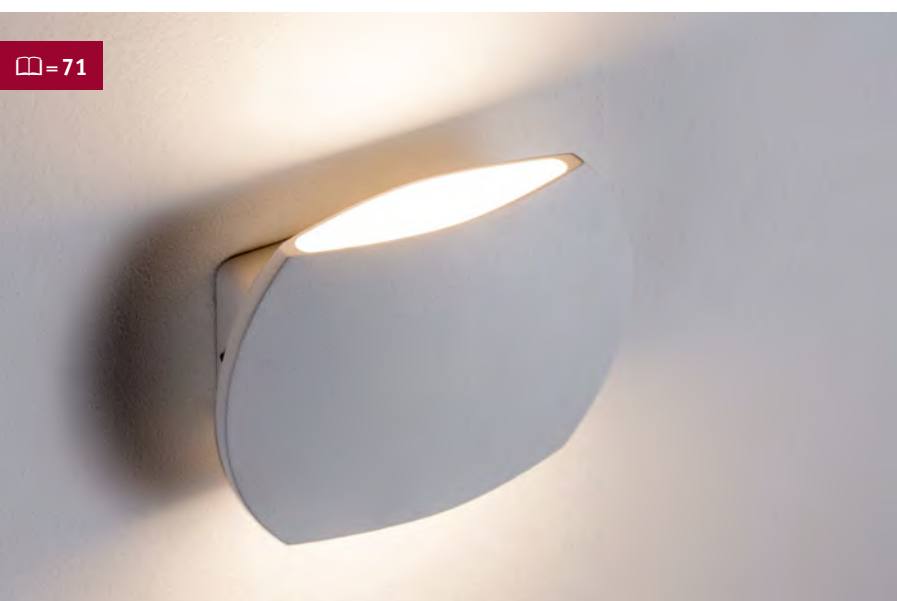

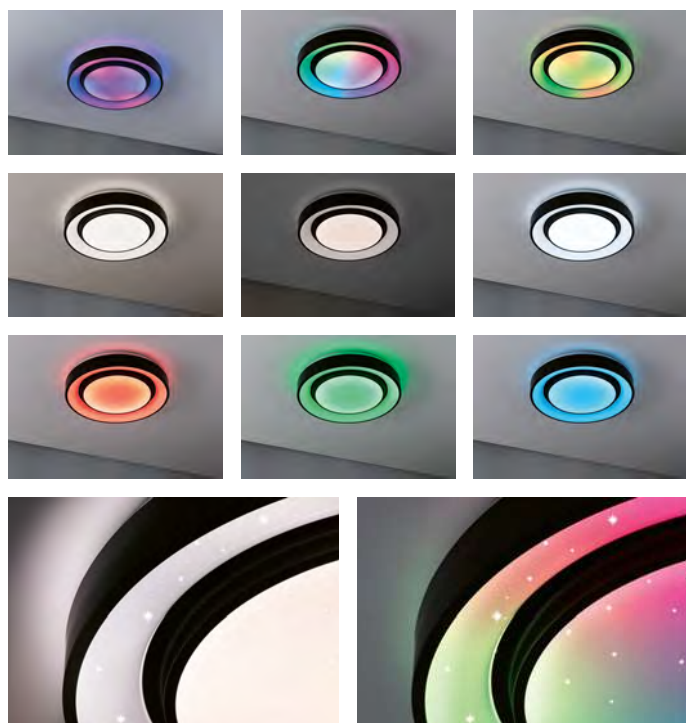

⌘ Schwarz/Weiß ⌘ Kunststoff/Metall  
 ⌘ Noir/Blanc ⌘ Matière plastique/Métal  
 ⌘ Zwart/Wit ⌘ Kunststof/Metaal



**Rainbow**  
 incl. 1×22 W  
 2.650 lm  
 3.000–6.500 K  
 230 V  
 ⌀70 ø375 mm  
 EAN 4000870 705445  
**705.44 new**

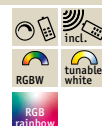

**Rainbow**  
 incl. 1×38,5 W  
 4.750 lm  
 3.000–6.500 K  
 230 V  
 ⌀70 ø475 mm  
 EAN 4000870 705452  
**705.45 new**



incl.



⌘ Chrom/Weiß ⌘ Kunststoff/Metall  
 ⌘ Chrome/Blanc ⌘ Matière plastique/Métal  
 ⌘ Chroom/Wit ⌘ Kunststof/Metaal



**Rainbow**  
 incl. 1×22 W  
 2.650 lm  
 3.000–6.500 K  
 230 V  
 ⌀75 ø380 mm  
 EAN 4000870 705469  
**705.46 new**



**Rainbow**  
 incl. 1×38,5 W  
 4.750 lm  
 3.000–6.500 K  
 230 V  
 ⌀75 ø485 mm  
 EAN 4000870 705476  
**705.47 new**



incl.

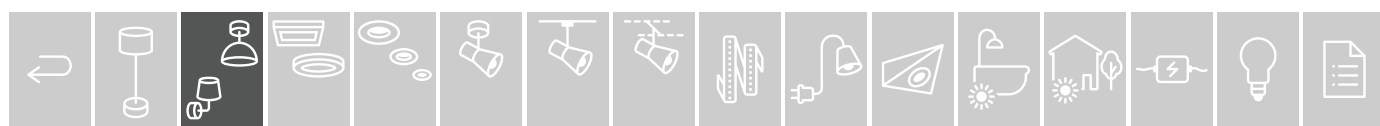

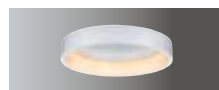

1x click 100%



2x click 50%



3x click 25%



3 step dim



**Ardora**

incl. 1x31 W  
2.956lm, 2.700 K  
230 V  
⌀85,5 ø450 mm  
EAN 4000870 709061  
**709.06**



- ☞ Weiß ☒ Metall/Kunststoff
- ☞ Blanc ☒ Métal/Matière plastique
- ☞ Wit ☒ Metaal/Kunststof



**Liao**

incl. 1x4,9 W  
500 lm, 3.000 K  
∠ 110°  
230 V  
⌀33 ø125 mm  
EAN 4000870 709429  
**709.42**



- ☞ Weiß matt/Chrom ☒ Metall
- ☞ Blanc dépoli/Chrome ☒ Métal
- ☞ Wit mat/Chroom ☒ Metaal







incl. memory function



1x click 100%









2x click 50%



3x click 25%

 3 step dim

-  Alu gebürstet  Metall
-  Alu brossé  Métal
-  Alu geborsteld  Metaal



**Argun**

incl. 1x4,2 W  
358 lm, 3.000 K  
230 V  
⌀60 ø97 mm  
EAN 4000870 797082  
**797.08**



**Argun**

incl. 2x4,2 W  
2x358 lm, 3.000 K  
230 V  
⌀60 ⇄189 ⌀97 mm  
EAN 4000870 797099  
**797.09**



**Argun**

incl. 3x4,2 W  
3x358 lm, 3.000 K  
230 V  
⌀60 ⇄284 ⌀97 mm  
EAN 4000870 797105  
**797.10**

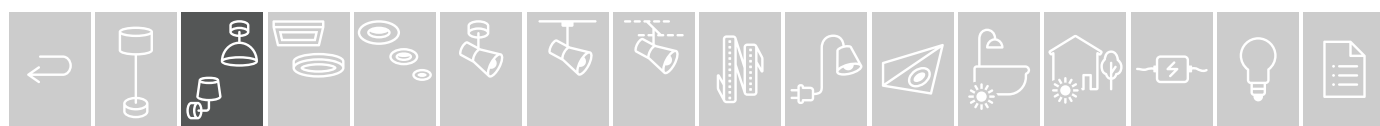



**Mari**  
 max. 2x20 W, E27  
 230 V  
 ⚡130 ø380 mm  
 EAN 4000870 709511  
**709.51**  
 📏 Blau 📏 Stoff  
 📏 Bleu 📏 Tissus  
 📏 Blauw 📏 Textiel



**Mari**  
 max. 2x20 W, E27  
 230 V  
 ⚡130 ø380 mm  
 EAN 4000870 709528  
**709.52**  
 📏 Beige 📏 Stoff  
 📏 Beige 📏 Tissus  
 📏 Beige 📏 Textiel

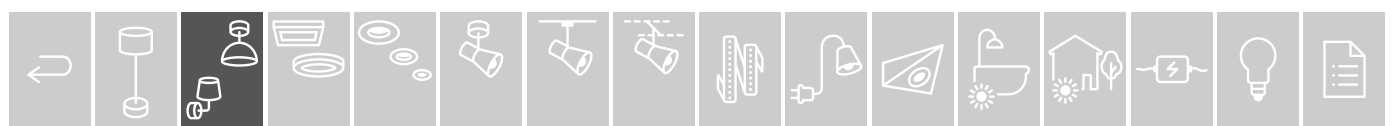



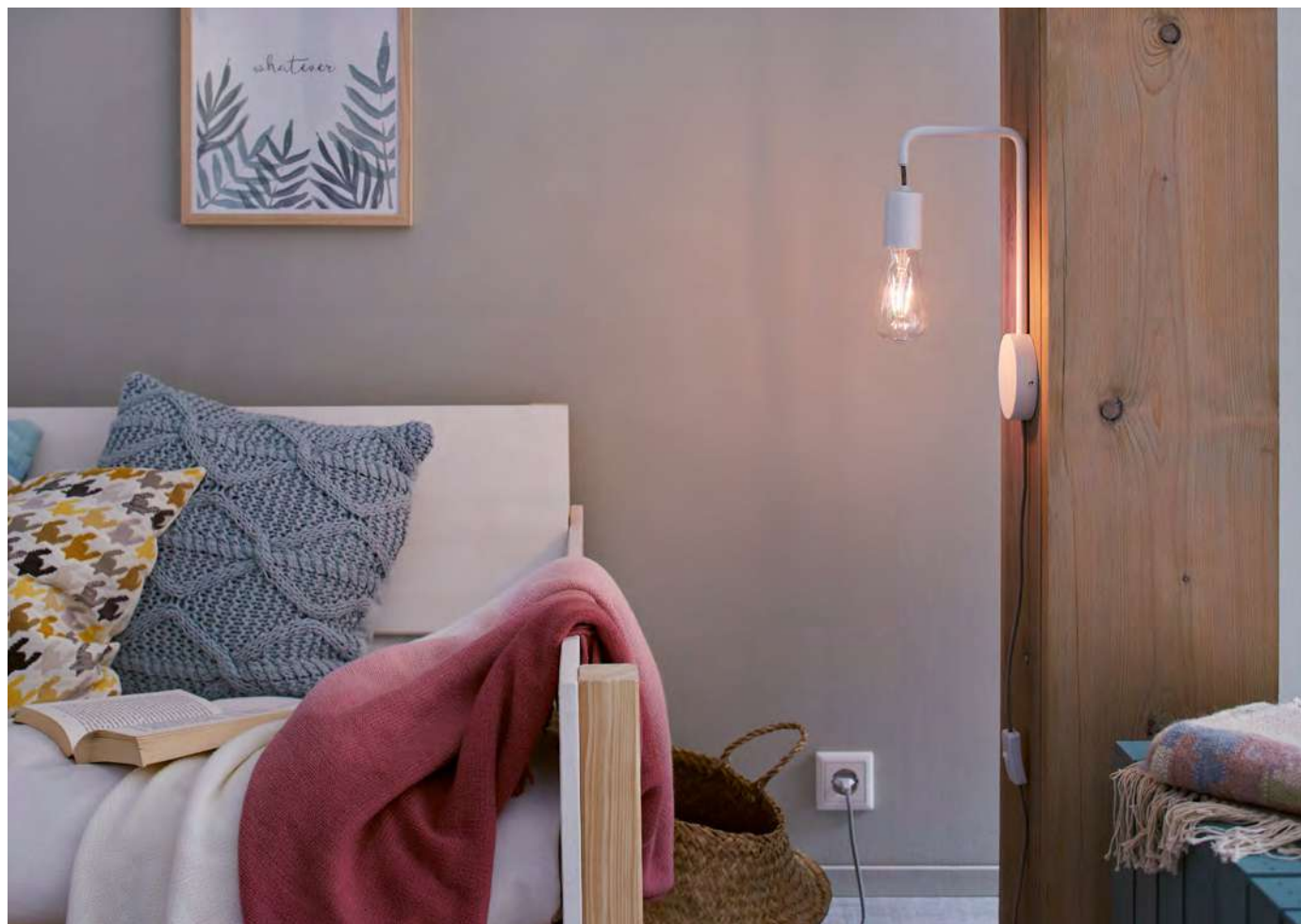

**Calvani**

max. 40W, E27  
230V  
340 ⇄ 100 ↗ 165 mm  
EAN 4000870 798119

**798.11**

- 🔗 Weiß 🏠 Metall
- 🔗 Blanc 🏠 Métal
- 🔗 Wit 🏠 Metaal



incl. USB Charger DC5V 2A



**Calvani**

max. 40W, E27  
230V  
350 ⇄ 200 ↗ 170 mm  
EAN 4000870 798126

**798.12**

- 🔗 Weiß 🏠 Metall
- 🔗 Blanc 🏠 Métal
- 🔗 Wit 🏠 Metaal

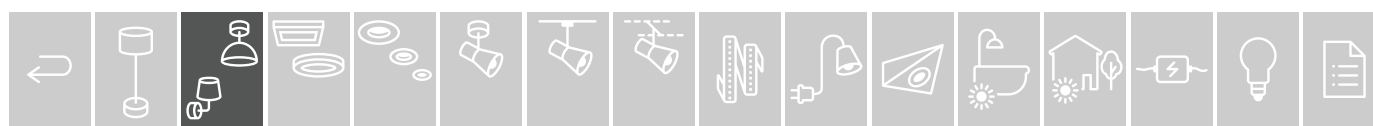



incl.  
USB Charger  
DC5V 2A



**Merani**

incl. 1x2,5 W, E27  
140 lm, 3.000 K  
23°  
230 V  
∅355 ∅250 ∅160 mm  
EAN 4000870 789131

**789.13**

- 🔧 Grau/Weiß 📦 Metall/Stoff
- 🔧 Gris/Blanc 📦 Métal/Tissus
- 🔧 Grijs/Wit 📦 Metaal/Textiel



**Kian**

max. 40W, E27  
230 V  
∅180 ∅45 ∅220 mm  
EAN 4000870 789148

**789.14**

- 🔧 Holz/Schwarz 📦 Metall/Holz
- 🔧 Bois/Noir 📦 Métal/Bois
- 🔧 Hout/Zwart 📦 Metaal/Hout

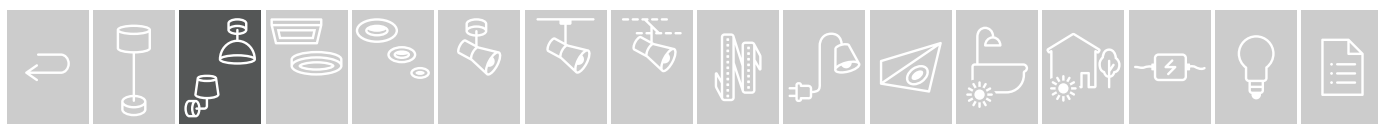
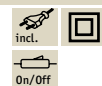



incl. USB Charger DC5V 2A



**Devara**

max. 40W, E27  
230V  
130 ⇄ 400 ↗ 170 mm  
EAN 4000870 789155

**789.15**

- 👉 Weiß 🏠 Metall
- 👉 Blanc 🏠 Métal
- 👉 Wit 🏠 Metaal



incl. USB Charger DC5V 2A



**Devara**

max. 40W, E27  
230V  
130 ⇄ 400 ↗ 170 mm  
EAN 4000870 789209

**789.20**

- 👉 Schwarz 🏠 Metall
- 👉 Noir 🏠 Métal
- 👉 Zwart 🏠 Metaal

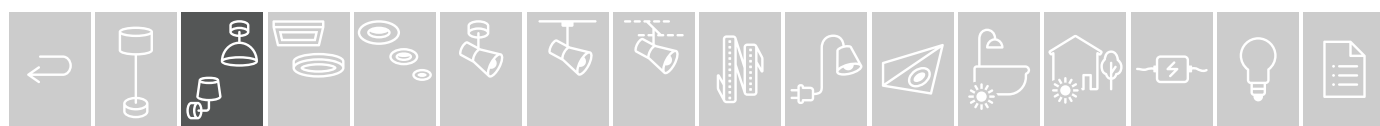

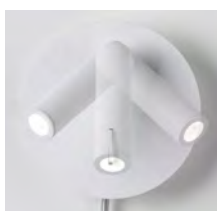

**Tabari**

incl. 1x3,2 W  
300 lm, 3.000 K  
∠ 38°  
230 V  
∅75 ∅140 mm  
EAN 4000870 789179

**789.17**

🔧 Weiß/Chrom 🏠 Metall  
🔧 Blanc/Chrome 🏠 Métal  
🔧 Wit/Chroom 🏠 Metaal

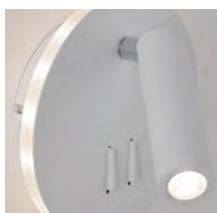
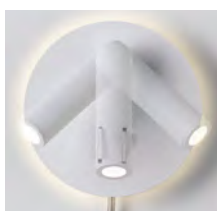

**Tabari**

incl. 1x3,25 / 1x2,4 W  
365 + 105 lm, 3.000 K  
∠ 38°  
230 V  
∅75 ∅140 mm  
EAN 4000870 789186

**789.18**

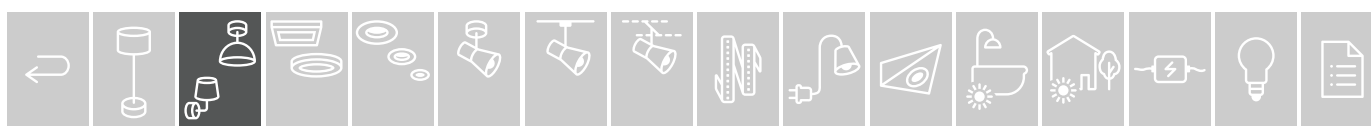

🔧 Weiß/Chrom 🏠 Metall  
🔧 Blanc/Chrome 🏠 Métal  
🔧 Wit/Chroom 🏠 Metaal











- 🔗 Weiß  Alu
- 🔗 Blanc  Alu
- 🔗 Wit  Alu

**Bar**

incl. 1×5,5 W  
765 lm, 2.700 K  
230 V, incl.  6 VA  
⌀70 ⇔200 ⚙️100 mm  
EAN 4000870 707906  
**707.90**

**Bar**

incl. 1×10,5 W  
1.500 lm, 2.700 K  
230 V, incl.  12 VA  
⌀70 ⇔400 ⚙️100 mm  
EAN 4000870 707913  
**707.91**

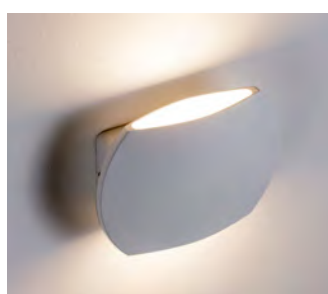
**Bocca**

incl. 2×3 W  
2×305 lm, 2.700 K  
230 V, incl.  6 VA  
⌀100 ⇔140 ⚙️52 mm  
EAN 4000870 707920  
**707.92**



- 🔗 Weiß  Alu
- 🔗 Blanc  Alu
- 🔗 Wit  Alu

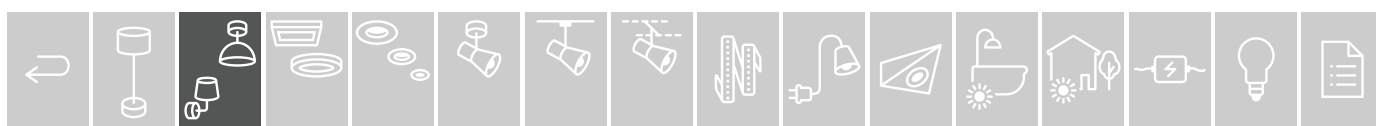

# Panels



## Flächiges Licht für jede Anwendung

LED Panels sind vielseitig einsetzbar - egal ob als Wand- oder Deckenleuchte, mit den LED Panels kann man einfach jeden Raum gleichmäßig und flächig ausleuchten. Durch die unaufdringliche Gestaltung und die flache Bauform fügen sich die Panels optimal in Wohn- oder Funktionsräume ein.

## Éclairage étendu pour toutes les applications

Les panneaux LED sont polyvalents : en tant qu'applications ou plafonniers, ils éclairent n'importe quelle pièce de manière homogène et étendue. Par une conception discrète et une forme plate, les panneaux se fondent parfaitement dans les pièces à vivre ou les espaces fonctionnels.

## Egaal licht voor elke toepassing

LED-panelen zijn veelzijdig toepasbaar, hetzij als wand- of als plafondlamp, met de LED-panelen kan elke ruimte op eenvoudige wijze gelijkmatig en egaal worden verlicht. Door de discrete vormgeving en de vlakke constructie passen de panelen perfect in woon- of functionele ruimtes.

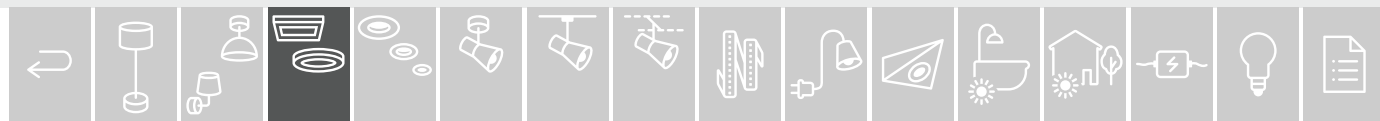

☒ = 75

DE Fünf aktuelle Farben: Weiß, Chrom, Chrom matt, Schwarz, Roségold  
FR Cinq couleurs actuelles : blanc, chrome, chrome mat, noir, or rose  
NL Vijf actuele kleuren: wit, chroom, chroom mat, zwart, rose goud

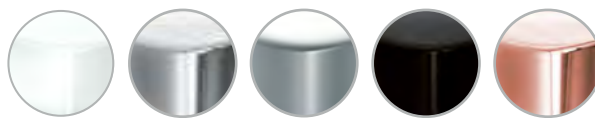

DE Neue Farben: Flieder, Graublau, Nachtblau, Dunkelgrau  
FR Nouvelles couleurs : lilas, gris bleu, bleu nuit, gris foncé  
NL Nieuwe kleuren: lila, grijsblauw, nachtblauw, donkergrijs

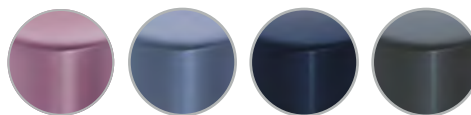

☒ = 78



☒ = 440



☒ = 440

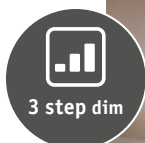

☒ = 82



☒ = 85

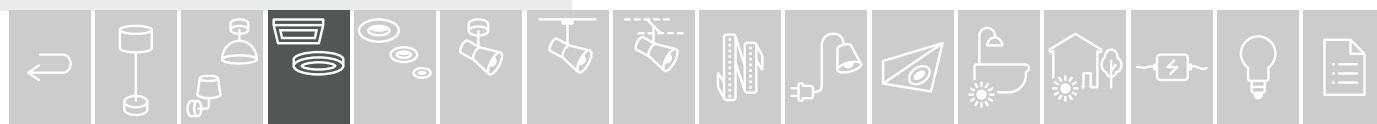
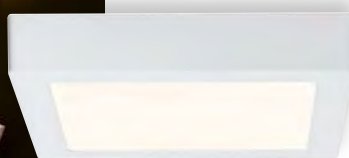

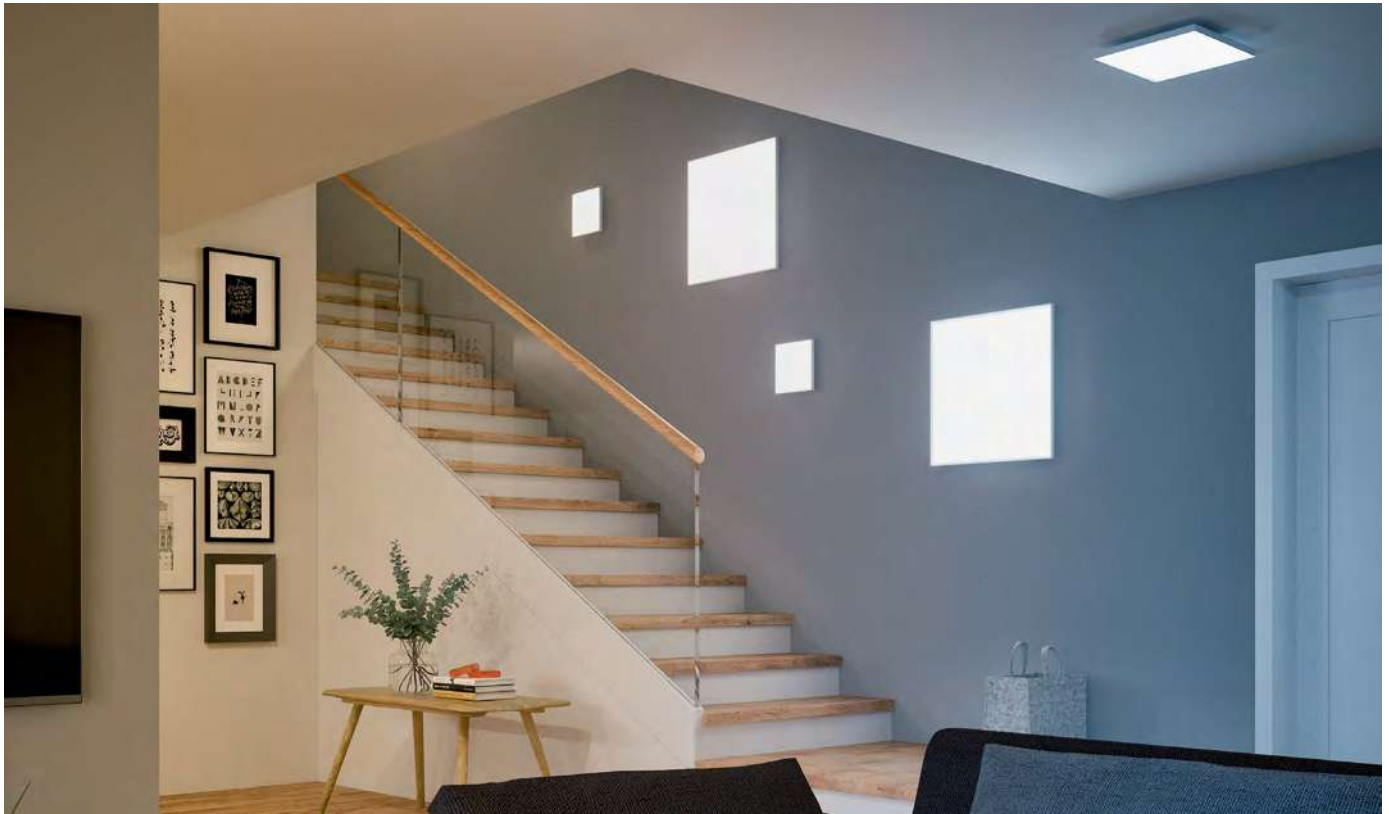

- ▶ Flächen aus purem Licht im Schweberahmen mit einer Aufbauhöhe von bis zu 69 mm
- ▶ Schatten- und blendfreie Beleuchtung für jeden Raum
- ▶ Steuerbare und smarte Varianten

- ▶ Des surfaces de lumière pure dans des cadres flottants avec une hauteur de montage de 69 mm
- ▶ Éclairage anti-éblouissement et sans ombres pour chaque pièce
- ▶ Variantes pilotables et intelligentes

- ▶ Vlakken vol puur licht in een zwevend frame met een opbouwhoogte van maximaal 69 mm
- ▶ Schaduwvrije en niet-verblindende verlichting voor elke ruimte
- ▶ Bestuurbare en smart varianten





smart  
controllable  
zigbee



**Velora** Metall Métal Metaal 230 V

tunable white = 2.700 - 6.500 K



⇄225 ⇄225 mm

**W** 1.020 lm | incl. 1×8,5 W EAN 4000870 798249 **798.24**

⇄295 ⇄295 mm

**W** 1.330 lm | incl. 1×10,5 W EAN 4000870 798256 **798.25**

ø400 mm

**W** 3.100 lm | incl. 1×22 W EAN 4000870 798959 **new 798.95**

⇄595 ⇄595 mm

**W** 2.650 lm | incl. 1×19,5 W EAN 4000870 798263 **798.26**

⇄595 ⇄295 mm

**W** 2.040 lm | incl. 1×15,5 W EAN 4000870 798270 **798.27**

RGBW – W = 3.000 K



ø300 mm

**W** 2.400 lm | incl. 1×16,5 W EAN 4000870 798997 **new 798.99**

ø400 mm

**W** 3.100 lm | incl. 1×22 W EAN 4000870 798973 **new 798.97**

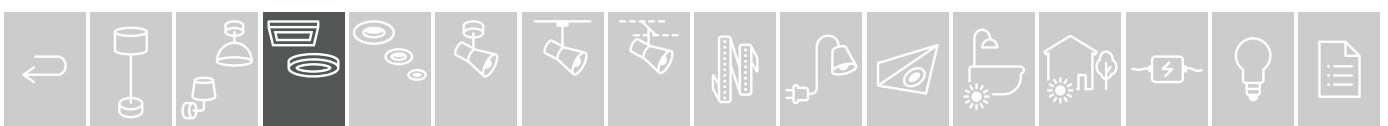



**Velora** Metall Métal Metaal 230V

white switch = 3.000 - 4.000 - 6.500 K

	<b>ø300 mm</b>	<b>W</b> 1.530 lm   incl. 1x13 W	EAN 4000870 798928 <b>new 798.92</b>
	<b>ø400 mm</b>	<b>W</b> 2.130 lm   incl. 1x19 W	EAN 4000870 798935 <b>new 798.93</b>

warm white = 3.000 K – 3 step dim

	<b>↔225 ↗225 mm</b>	<b>W</b> 1.500 lm   incl. 1x12 W	EAN 4000870 798201 <b>798.20</b>
	<b>↔295 ↗295 mm</b>	<b>W</b> 2.100 lm   incl. 1x17 W	EAN 4000870 798218 <b>798.21</b>
	<b>↔595 ↗595 mm</b>	<b>W</b> 4.400 lm   incl. 1x34 W	EAN 4000870 798225 <b>798.22</b>
	<b>↔595 ↗295 mm</b>	<b>W</b> 3.300 lm   incl. 1x26 W	EAN 4000870 798232 <b>798.23</b>

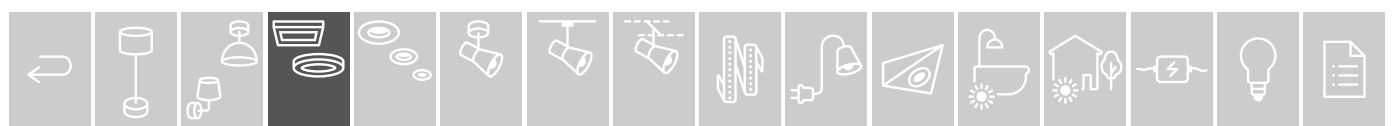



Velora

Metall Métal Metaal

230V

 warm white = 3.000K

↔225 ↗225 mm

<b>W</b>	1.480 lm		incl. 1×13 W	EAN 4000870 798164	<b>798.16</b>
----------	----------	--	--------------	--------------------	---------------



ø300 mm

<b>W</b>	1.500 lm		incl. 1×13 W	EAN 4000870 798904	<b>new 798.90</b>
----------	----------	--	--------------	--------------------	-------------------



↔300 ↗300 mm

<b>W</b>	1.860 lm		incl. 1×16,8 W	EAN 4000870 798171	<b>798.17</b>
----------	----------	--	----------------	--------------------	---------------



ø400 mm

<b>W</b>	2.100 lm		incl. 1×19 W	EAN 4000870 798911	<b>new 798.91</b>
----------	----------	--	--------------	--------------------	-------------------



↔600 ↗600 mm

<b>W</b>	4.270 lm		incl. 1×34,2 W	EAN 4000870 798188	<b>798.18</b>
----------	----------	--	----------------	--------------------	---------------



↔600 ↗300 mm

<b>W</b>	3.280 lm		incl. 1×29 W	EAN 4000870 798195	<b>798.19</b>
----------	----------	--	--------------	--------------------	---------------

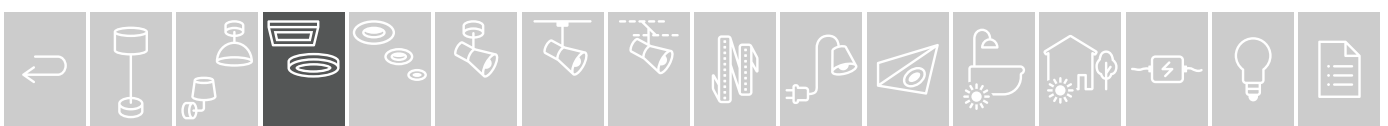

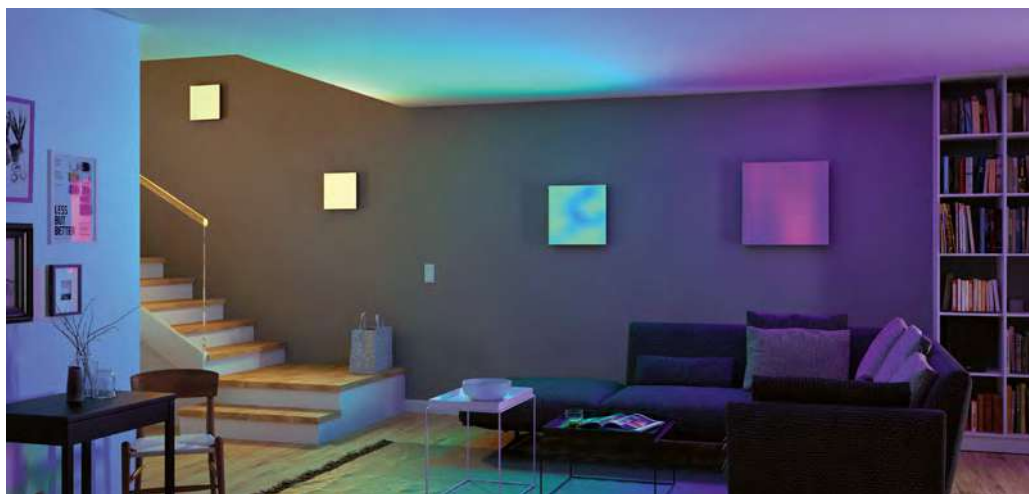

DE Jede Licht-Szene kann in der Geschwindigkeit angepasst und als Standbild eingefroren werden.

FR La vitesse de chaque scénario d'éclairage peut être adaptée et figée comme un plan fixe.

NL Elke lichtscène kan in snelheid worden aangepast en als stilstand beeld worden bevroren.

- ▶ Velora Rainbow verbindet hervorragende Raumbelichtung mit purer Farbmagie, denn hier sind beste Lichteigenschaften mit dynamischen Farbeffekten neu kombiniert.
- ▶ Per Fernbedienung ist die Farbtemperatur stufenlos von 3000 K bis 6500 K sowie 16 voreingestellte Animationen und mit dynamischer Farbsteuerung einstellbar.
- ▶ Velora Rainbow ist stufenlos dimmbar und hat eine integrierte Nachtlichtfunktion.
- ▶ Die hochwertige mattierte Lichtfläche ist in einem randlosen eleganten Schweberrahmen integriert.
- ▶ Velora Rainbow allie un excellent éclairage de la pièce à la pure magie des couleurs, car ici, les meilleures caractéristiques d'éclairage se trouvent combinées à des effets de couleur dynamiques.
- ▶ La température de couleur est réglable en continu de 3 000 K à 6 500 K par télécommande, sans oublier 16 animations prédéfinies et le contrôle de la couleur dynamique.
- ▶ Velora Rainbow est réglable en continu et dispose d'une fonction veilleuse intégrée.
- ▶ La surface lumineuse mate de haute qualité est intégrée dans un cadre flottant sans bords, particulièrement élégant.
- ▶ Velora Rainbow combineert een uitstekende ruimteverlichting met pure kleurenmagie, want hier zijn nieuwe combinaties gemaakt van de beste verlichtingseigenschappen en dynamische kleureffecten.
- ▶ Met de afstandsbediening kan de kleurtemperatuur traploos van 3000 K tot 6500 K worden geregeld en zijn 16 vooraf ingestelde animaties met dynamische kleurbesturing instelbaar.
- ▶ Velora Rainbow is traploos dimbaar en heeft een geïntegreerde nachtlichtfunctie.
- ▶ Het hoogwaardige gematteerde lichtvlak is geïntegreerd in een randloos, elegant zwevend frame.



Velora Rainbow **new**

Metall Métal Metaal

230V

RGBW – W = 3.000 - 6.500 K

↔295 ↻295 mm

<b>W</b>	1.420 lm	incl. 1x13,2W	EAN 4000870 799048	<b>799.04</b>
<b>B</b>	1.420 lm	incl. 1x13,2W	EAN 4000870 799079	<b>799.07</b>

↔450 ↻450 mm

<b>W</b>	2.110 lm	incl. 1x19W	EAN 4000870 799055	<b>799.05</b>
<b>B</b>	2.110 lm	incl. 1x19W	EAN 4000870 799086	<b>799.08</b>

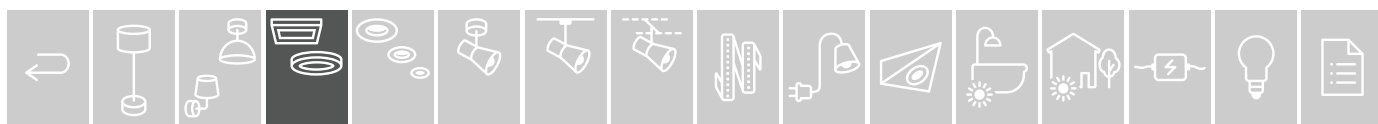





- ▶ Flache Bauformen mit einer Aufbauhöhe von nur 40 bis 52 mm
- ▶ Steuerbar mit Smart Home Zigbee Fernbedienung oder per App
- ▶ Weiterhin über den Lichtschalter ein- und ausschaltbar
- ▶ Profils plats avec une hauteur de montage de seulement 40 mm à 52 mm
- ▶ Contrôlable par la télécommande Smart Home ZigBee ou via l'application
- ▶ S'allument et s'éteignent également via l'interrupteur
- ▶ Vlakke bouwvormen met een opbouwhoogte van slechts 40 tot 52 mm
- ▶ Bestuurbaar met Smart Home ZigBee afstandsbediening of app
- ▶ Verder via de lichtschakelaar in- en uitschakelbaar

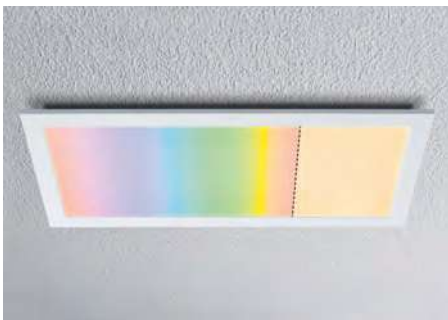

smart  
controllable  
**zigbee**



**Amaris** Metall Métal Metaal 230V

RGBW – W = 2.700 - 6.500 K



↔595 ↗295 mm

**W** 2.300 lm | incl. 1x20,2W EAN 4000870 798089 **798.08**

↔595 ↗595 mm

**W** 4.000 lm | incl. 1x35W EAN 4000870 798096 **798.09**

↔1.195 ↗295 mm

**W** 4.100 lm | incl. 1x38W EAN 4000870 798102 **798.10**

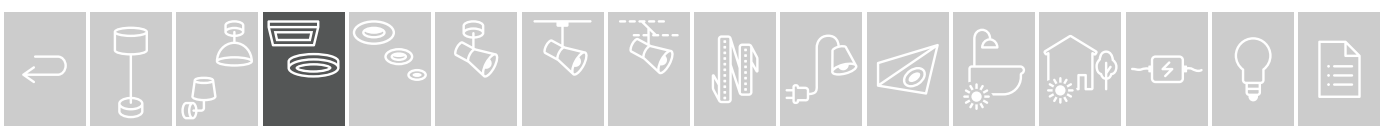



- ▶ Die Panel-Serie Atria Shine beinhaltet ein komplettes Sortiment mit modernster Beleuchtungstechnik und ist ideal für die Grundbeleuchtung von Wohn- und Schlafräumen oder Küchen geeignet.
- ▶ Alle Leuchten dieser Serie sind mit moderner Backlight Technik ausgestattet und haben eine sehr geringe Aufbauhöhe von gerade mal 28mm. Dadurch wirken die Leuchten modern, dezent und fast schwebend an Wand und Decke.
- ▶ Die Atria Shine Serie ist zudem durch einen besonderen Drehverschluss sehr montagefreundlich.
- ▶ Neben einfach schaltbaren Leuchten in neutralweißem und warmweißem Licht, sind Varianten mit Stufendimmung per Lichtschalter oder Farbsteuerung per Fernbedienung erhältlich.
- ▶ La gamme de panneaux Atria Shine comprend une gamme complète dotée de la technologie d'éclairage la plus moderne et est idéale pour l'éclairage de base des salons, chambres ou cuisines.
- ▶ Tous les luminaires de cette gamme sont dotés de la technologie moderne Backlight et disposent d'une hauteur de montage très faible d'à peine 28 mm. Les luminaires obtiennent de la sorte une aspect moderne, discret et presque flottant au niveau du mur et du plafond.
- ▶ La gamme Atria Shine est en outre très facile à poser grâce à un bouchon à vis spécial.
- ▶ En sus des luminaires facilement commutables en blanc neutre et blanc chaud, des modèles avec gradation par paliers sur interrupteur ou contrôle des couleurs par télécommande sont disponibles.
- ▶ De paneelserie Atria Shine omvat een compleet assortiment met de modernste verlichtingstechniek en is ideaal als basisverlichting van woon- en slaapruidtes of keukens.
- ▶ Alle armaturen uit deze serie zijn uitgerust met moderne backlight-techniek en hebben een zeer geringe opbouwhoogte van amper 28 mm. Hierdoor hebben de armaturen een modern, subtiel en nagenoeg zwevend effect aan de wand en het plafond.
- ▶ Dankzij een speciale draaisluiting is de Atria Shine serie bovendien zeer montagevriendelijk.
- ▶ Naast eenvoudig schakelbare armaturen in neutraalwit en warmwit licht zijn varianten met stapsgewijze dimmer via de lichtschakelaar of kleurbesturing met afstandsbediening verkrijgbaar.

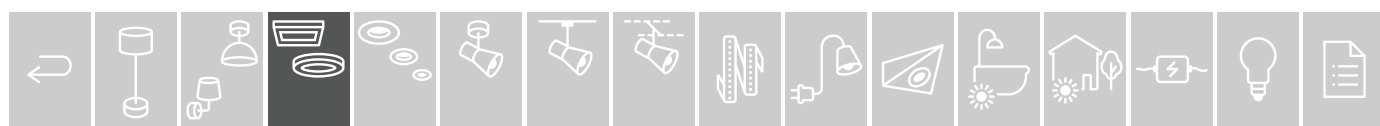

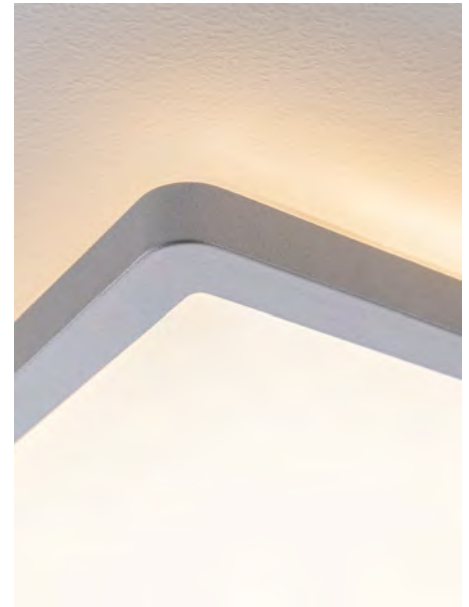

**Atria Shine new**

☒ Kunststoff Matière plastique Kunststoff

230V



RGBW – W = 4.000 K



**ø293 mm**

**CM** 1.800 lm | incl. 1x12 W EAN 4000870 710180 **710.18**

**ø420 mm**

**CM** 2.800 lm | incl. 1x20 W EAN 4000870 710197 **710.19**

**↔580 ↗200 mm**

**CM** 2.800 lm | incl. 1x20 W EAN 4000870 710203 **710.20**

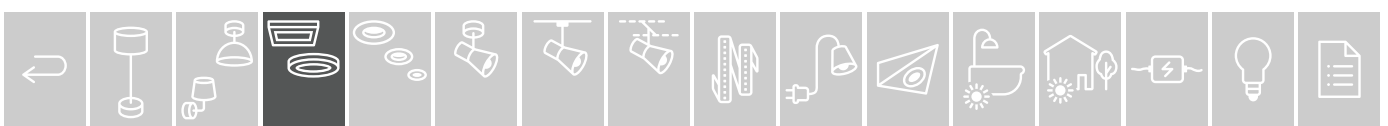



**Atria Shine new** Kunststoff Matière plastique Kunststoff 230V

warm white = 3.000 K – 3 step dim



**ø420 mm**

**CM** 2.800 lm | incl. 1x22 W EAN 4000870 709924 **709.92**

**B** 2.800 lm | incl. 1x22 W EAN 4000870 709993 **709.99**



**↔420 ↗420 mm**

**CM** 2.700 lm | incl. 1x22 W EAN 4000870 709955 **709.95**

**B** 2.700 lm | incl. 1x22 W EAN 4000870 710029 **710.02**



**↔580 ↗200 mm**

**CM** 2.700 lm | incl. 1x22 W EAN 4000870 709962 **709.96**

**B** 2.700 lm | incl. 1x22 W EAN 4000870 710036 **710.03**

neutral white = 4.000 K – 3 step dim



**ø420 mm**

**CM** 2.800 lm | incl. 1x22 W EAN 4000870 710067 **710.06**

**B** 2.800 lm | incl. 1x22 W EAN 4000870 710135 **710.13**



**↔420 ↗420 mm**

**CM** 2.700 lm | incl. 1x22 W EAN 4000870 710098 **710.09**

**B** 2.700 lm | incl. 1x22 W EAN 4000870 710166 **710.16**



**↔580 ↗200 mm**

**CM** 2.700 lm | incl. 1x22 W EAN 4000870 710104 **710.10**

**B** 2.700 lm | incl. 1x22 W EAN 4000870 710173 **710.17**

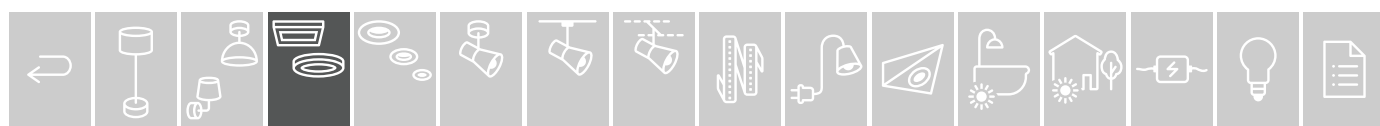



**Atria Shine new** Kunststoff Matière plastique Kunststoff 230V

● warm white = 3.000 K

      	<p><b>ø190 mm</b></p> <hr/> <p><b>CM</b> 1.340 lm   incl. 1×11,2 W <span style="float: right;">EAN 4000870 709900 <b>709.90</b></span></p> <p><b>B</b> 1.340 lm   incl. 1×11,2 W <span style="float: right;">EAN 4000870 709979 <b>709.97</b></span></p> <p>↔<b>190</b> ↗<b>190 mm</b></p> <hr/> <p><b>CM</b> 1.360 lm   incl. 1×11,2 W <span style="float: right;">EAN 4000870 709931 <b>709.93</b></span></p> <p><b>B</b> 1.360 lm   incl. 1×11,2 W <span style="float: right;">EAN 4000870 710005 <b>710.00</b></span></p> <p><b>ø293 mm</b></p> <hr/> <p><b>CM</b> 2.000 lm   incl. 1×16 W <span style="float: right;">EAN 4000870 709917 <b>709.91</b></span></p> <p><b>B</b> 2.000 lm   incl. 1×16 W <span style="float: right;">EAN 4000870 709986 <b>709.98</b></span></p> <p>↔<b>293</b> ↗<b>293 mm</b></p> <hr/> <p><b>CM</b> 2.000 lm   incl. 1×16 W <span style="float: right;">EAN 4000870 709948 <b>709.94</b></span></p> <p><b>B</b> 2.000 lm   incl. 1×16 W <span style="float: right;">EAN 4000870 710012 <b>710.01</b></span></p>
---	---

○ neutral white = 4.000 K

      	<p><b>ø190 mm</b></p> <hr/> <p><b>CM</b> 1.340 lm   incl. 1×11,2 W <span style="float: right;">EAN 4000870 710043 <b>710.04</b></span></p> <p><b>B</b> 1.340 lm   incl. 1×11,2 W <span style="float: right;">EAN 4000870 710111 <b>710.11</b></span></p> <p>↔<b>190</b> ↗<b>190 mm</b></p> <hr/> <p><b>CM</b> 1.360 lm   incl. 1×11,2 W <span style="float: right;">EAN 4000870 710074 <b>710.07</b></span></p> <p><b>B</b> 1.360 lm   incl. 1×11,2 W <span style="float: right;">EAN 4000870 710142 <b>710.14</b></span></p> <p><b>ø293 mm</b></p> <hr/> <p><b>CM</b> 2.000 lm   incl. 1×16 W <span style="float: right;">EAN 4000870 710050 <b>710.05</b></span></p> <p><b>B</b> 2.000 lm   incl. 1×16 W <span style="float: right;">EAN 4000870 710128 <b>710.12</b></span></p> <p>↔<b>293</b> ↗<b>293 mm</b></p> <hr/> <p><b>CM</b> 2.000 lm   incl. 1×16 W <span style="float: right;">EAN 4000870 710081 <b>710.08</b></span></p> <p><b>B</b> 2.000 lm   incl. 1×16 W <span style="float: right;">EAN 4000870 710159 <b>710.15</b></span></p>
--	---







**Atria**

☒ Kunststoff Matière plastique Kunststoff

230V

  warm white = 2.700 K – dimmable



**ø220 mm**

**W** 1.500 lm | incl. 1×14 W EAN 4000870 708682 **708.68**

**CM** 1.500 lm | incl. 1×14 W EAN 4000870 708644 **708.64**



**⇔220 ↗220 mm**

**W** 1.500 lm | incl. 1×14 W EAN 4000870 708705 **708.70**

**CM** 1.500 lm | incl. 1×14 W EAN 4000870 708668 **708.66**



**ø300 mm**

**W** 1.800 lm | incl. 1×16 W EAN 4000870 708699 **708.69**

**CM** 1.800 lm | incl. 1×16 W EAN 4000870 708651 **708.65**

**RG** 1.800 lm | incl. 1×16 W EAN 4000870 708729 **708.72**



**⇔300 ↗300 mm**

**W** 1.800 lm | incl. 1×16,5 W EAN 4000870 708712 **708.71**

**CM** 1.800 lm | incl. 1×16,5 W EAN 4000870 708675 **708.67**

**RG** 1.800 lm | incl. 1×16,5 W EAN 4000870 708736 **708.73**

 neutral white = 4.000 K



**ø220 mm**

**W** 1.500 lm | incl. 1×14 W EAN 4000870 709375 **709.37**

**CM** 1.500 lm | incl. 1×14 W EAN 4000870 709337 **709.33**



**⇔220 ↗220 mm**

**CM** 1.500 lm | incl. 1×14 W EAN 4000870 709351 **709.35**

**W** 1.500 lm | incl. 1×14 W EAN 4000870 709382 **709.38**



**ø300 mm**

**CM** 1.800 lm | incl. 1×16 W EAN 4000870 709344 **709.34**

**RG** 1.800 lm | incl. 1×16 W EAN 4000870 709405 **709.40**



**⇔300 ↗300 mm**

**CM** 1.800 lm | incl. 1×16,5 W EAN 4000870 709368 **709.36**

**W** 1.800 lm | incl. 1×16,5 W EAN 4000870 709399 **709.39**

**RG** 1.800 lm | incl. 1×20 W EAN 4000870 709412 **709.41**





Lunar

Alu Alu Alu

230V

 warm white = 3.000K
**ø170 mm**

<b>W</b>	1.230 lm		incl. 1×11 W		EAN 4000870 706411	<b>706.41</b>
----------	----------	--	--------------	--	--------------------	---------------

<b>CM</b>	1.230 lm		incl. 1×11 W		EAN 4000870 706534	<b>706.53</b>
-----------	----------	--	--------------	--	--------------------	---------------

**⇔170 ↗170 mm**

<b>W</b>	1.230 lm		incl. 1×11 W		EAN 4000870 706442	<b>706.44</b>
----------	----------	--	--------------	--	--------------------	---------------

<b>CM</b>	1.230 lm		incl. 1×11 W		EAN 4000870 706480	<b>706.48</b>
-----------	----------	--	--------------	--	--------------------	---------------

**ø225 mm**

<b>W</b>	1.520 lm		incl. 1×12,5 W		EAN 4000870 706428	<b>706.42</b>
----------	----------	--	----------------	--	--------------------	---------------

<b>CM</b>	1.520 lm		incl. 1×12,5 W		EAN 4000870 706541	<b>706.54</b>
-----------	----------	--	----------------	--	--------------------	---------------

**⇔225 ↗225 mm**

<b>W</b>	1.520 lm		incl. 1×12,5 W		EAN 4000870 706459	<b>706.45</b>
----------	----------	--	----------------	--	--------------------	---------------

<b>CM</b>	1.520 lm		incl. 1×12,5 W		EAN 4000870 706497	<b>706.49</b>
-----------	----------	--	----------------	--	--------------------	---------------

**ø300 mm**

<b>W</b>	1.700 lm		incl. 1×16 W		EAN 4000870 706435	<b>706.43</b>
----------	----------	--	--------------	--	--------------------	---------------

<b>CM</b>	1.700 lm		incl. 1×16 W		EAN 4000870 706558	<b>706.55</b>
-----------	----------	--	--------------	--	--------------------	---------------

**⇔300 ↗300 mm**

<b>W</b>	1.950 lm		incl. 1×16 W		EAN 4000870 706466	<b>706.46</b>
----------	----------	--	--------------	--	--------------------	---------------

<b>CM</b>	1.886 lm		incl. 1×16 W		EAN 4000870 706503	<b>706.50</b>
-----------	----------	--	--------------	--	--------------------	---------------

**ø400 mm**

<b>CM</b>	2.600 lm		incl. 1×22 W		EAN 4000870 706565	<b>706.56</b>
-----------	----------	--	--------------	--	--------------------	---------------

**⇔400 ↗400 mm**

<b>CM</b>	2.400 lm		incl. 1×22 W		EAN 4000870 706510	<b>706.51</b>
-----------	----------	--	--------------	--	--------------------	---------------

**⇔600 ↗600 mm**

<b>W</b>	3.200 lm		incl. 1×25 W		EAN 4000870 706473	<b>706.47</b>
----------	----------	--	--------------	--	--------------------	---------------

<b>CM</b>	3.050 lm		incl. 1×25 W		EAN 4000870 706527	<b>706.52</b>
-----------	----------	--	--------------	--	--------------------	---------------

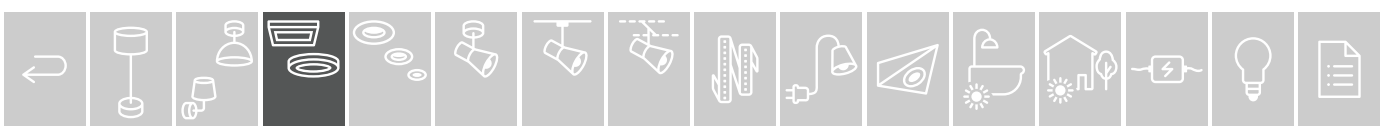



Abia

☒ Kunststoff Matière plastique Kunststoff

230V

● warm white = 2.700 K



ø300 mm

<b>W</b>	3.200 lm		incl. 1x22 W	EAN 4000870 708996	<b>708.99</b>
<b>CM</b>	3.200 lm		incl. 1x22 W	EAN 4000870 709832	<b>709.83</b>
<b>B</b>	3.200 lm		incl. 1x22 W	EAN 4000870 709849	<b>709.84</b>



↔300 ↗300 mm

<b>W</b>	3.200 lm		incl. 1x22 W	EAN 4000870 709009	<b>709.00</b>
<b>CM</b>	3.200 lm		incl. 1x22 W	EAN 4000870 709825	<b>709.82</b>
<b>B</b>	3.200 lm		incl. 1x22 W	EAN 4000870 709856	<b>709.85</b>







**Abia new** Kunststoff Matière plastique Kunststoff 230V

● warm white = 2.700 K



**ø300 mm**

<b>L</b>	3.200 lm		incl. 1x22 W	EAN 4000870 709894	<b>709.89</b>
<b>DG</b>	3.200 lm		incl. 1x22 W	EAN 4000870 709887	<b>709.88</b>
<b>MB</b>	3.200 lm		incl. 1x22 W	EAN 4000870 709863	<b>709.86</b>
<b>PB</b>	3.200 lm		incl. 1x22 W	EAN 4000870 709870	<b>709.87</b>



**Aviar** Kunststoff Matière plastique Kunststoff 230V

● warm white = 3.000 K – dimmable



**ø220 mm**

<b>C</b>	1.400 lm		incl. 1x12,6 W	EAN 4000870 789216	<b>789.21</b>
<b>W</b>	1.400 lm		incl. 1x12,6 W	EAN 4000870 789230	<b>789.23</b>

neutral white = 4.000 K – dimmable



**ø220 mm**

<b>C</b>	1.300 lm		incl. 1x12,7 W	EAN 4000870 789223	<b>789.22</b>
----------	----------	--	----------------	--------------------	---------------



# Downlights

- 91 Base
- 92 Nova
- 96 Nova Plus
- 105 Nova mini
- 106 Choose!
- 108 Classic
- 117 Coins
- 119 Decorative
- 124 Panels
- 138 Wall
- 141 Accessories



☰=91

## Downlights

### Einbauleuchten bieten zahllose Anwendungsmöglichkeiten

Eine große Auswahl an aktuellen LED-Modellen sorgt – in die Decke montiert – für Raumausleuchtung oder auch Akzentbeleuchtung. Moderne Einbauleuchten mit besonders flacher Einbautiefe und wechselbarem LED-Modul benötigen keinen Trafo und lassen sich uneingeschränkt miteinander verbinden. Im Sortiment von Paulmann sind sie in vielen Farben und Formen, dimmbar, schwenkbar und besonders spritz- oder strahlwassergeschützt (IP44, IP65 z.B. für das Bad) zu finden. Auch für viele weitere Einsatzzwecke gibt es die passende Einbauleuchte: Strahler für den Einbau in Möbeln, um etwa Schränke oder Vitrinen beleuchten zu können oder auch für den Wandeinbau, wo sie als Orientierungsbeleuchtung im Flur oder Treppenhaus dienen können.

### Les spots encastrés offrent de multiples possibilités d'application

Un vaste choix de modèles LED actuels montés au plafond veille à l'éclairage de la pièce ou à l'accentuation d'éléments. Les spots encastrés modernes avec une profondeur d'encastrement particulièrement faible et un module LED interchangeable n'ont pas besoin de transformateur et se raccordent les uns aux autres sans aucune limite. La gamme de Paulmann est disponible dans de nombreuses couleurs et formes, en version gradable, orientable et particulièrement bien protégée contre les projections et les jets d'eau (IP44, IP65 par ex. pour la salle de bain). Les spots encastrés adaptés existent aussi pour de nombreuses autres finalités : projecteurs pour l'encastrement dans des meubles, par exemple pour éclairer des armoires ou des vitrines, mais aussi pour la pose murale, où ils peuvent servir d'éclairage d'orientation dans les couloirs et cages d'escalier.

## Base, Nova, Nova Plus

### Inbouwlampen bieden talrijke toepassingsmogelijkheden

Een groot aanbod van actuele modellen (ingebouwd in het plafond) zorgt voor verlichting van ruimtes, maar ook voor accentverlichting. Moderne inbouwlampen met een bijzonder kleine inbouwdiepte en verwisselbare LED-module hebben geen trafo nodig en kunnen onbeperkt met elkaar worden verbonden. In het assortiment van Paulmann zijn ze in vele kleuren en vormen, dimbaar, zwenkbaar en extra spat- en straalwaterdicht (IP44, IP65 bijv. voor de badkamer) te vinden. Ook voor veel andere toepassingen is de juiste inbouwlamp te vinden: spots voor de inbouw in meubels om bijvoorbeeld kasten of vitrines te verlichten, maar ook voor inbouw in de wand, waar ze als oriënteringsverlichting in de gang of het trappenhuis kunnen dienen.

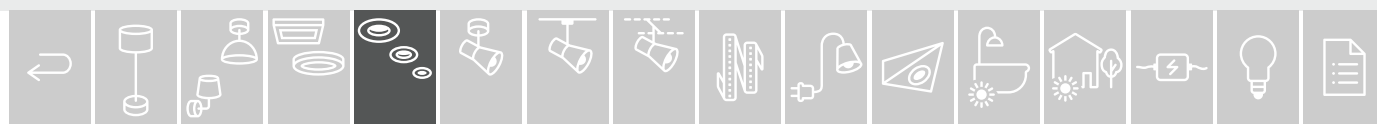
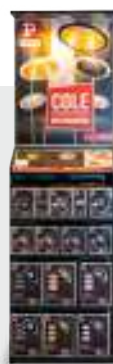
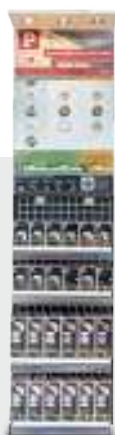



☐=105 Nova mini



Choose! ☐=106



Decorative ☐=119



☐=124 Panels

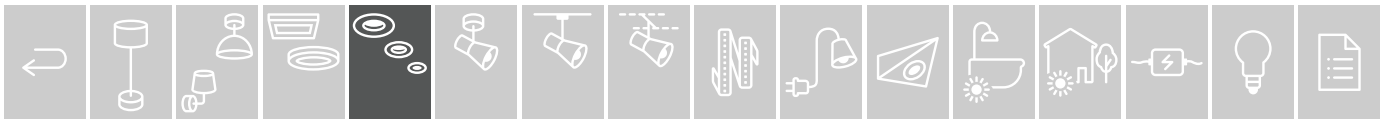

Easy to Shop – Paulmann Einbauleuchten Sortiment  
 Easy to Shop – Gamme de spots encastrés Paulmann  
 Easy to Shop – Assortiment inbouwlampen van Paulmann

☐=91

☐=92-95

☐=96-102

Base		Nova			Nova Plus			
 <b>IP23</b> Schwenkbar Orientable Zwenkbaar	 <b>IP23</b> Schwenkbar Orientable Zwenkbaar	 <b>IP44</b> Starr Fixe Stijf	 <b>IP23</b> Schwenkbar Orientable Zwenkbaar	 <b>IP65</b> Starr Fixe Stijf	 <b>IP65</b> Schwenkbar Orientable Zwenkbaar			
 <b>COIN GU10</b>	 <b>COIN GU10</b>	 <b>COIN GU10</b>	 <b>COIN</b>	 <b>COIN</b>	 <b>COIN GU10</b>			
 <b>3 step dim</b>	 <b>3 step dim</b>	 <b>3 step dim</b>	 <b>dimmbare</b>	 <b>dimmbare</b>	 <b>dimmbare</b>			
 <b>COIN GU10</b>  3000 K	 <b>COIN GU10</b>  2700 K	 <b>COIN GU10</b>  2700 K	 smart controllable  <b>zigbee</b>			 <b>dimmbare</b>	 <b>tunable white</b>	 <b>RGBW</b>
 Metall Métal Metaal	 Alu Alu Alu		 Alu Alu Alu					

**dimmbare**    Stufenlos dimmbare  
 Gradable en continu  
 Traploos dimbaar

**3 step dim**    100%  
 50%  
 25%  
 off

Per Wandschalter in Stufen dimmbare  
 Gradable par niveaux via un interrupteur mural  
 Dimbaar in drie standen via wandschakelaar

 Sicher anschließen, ohne Trafo Raccordement sûr, sans transfo Veilig aansluiten, zonder trafo	 Endlos verkettbar mit enthaltener Anschlussbox Raccordable à l'infini avec boîtier de raccordement inclus Eindeloos verbindbaar met inbegrepen aansluitbox	 Bohrdurchmesser im 68mm-Standard Diamètre de perçage standard 68 mm Standaard boordiameter van 68 mm	 Haltefedern für einfachen Ein- und Ausbau Ressorts de retenue pour un montage et démontage faciles Sluitveren voor eenvoudige montage en demontage	 Mit wechselbarem Leuchtmittel Ampoule amovible incluse Met vervangbaar verlichtingsmiddel	<b>Sets</b> 3er-Set reicht für 12m <sup>2</sup> -15m <sup>2</sup> Grundbeleuchtung Kit de 3 suffisant pour un éclairage de base de 12 m <sup>2</sup> à 15 m <sup>2</sup> Set van 3 volstaat voor 12 m <sup>2</sup> tot 15 m <sup>2</sup> basisverlichting
--	--	---	---	--	---

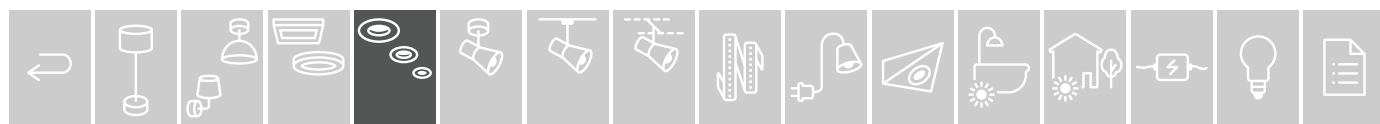

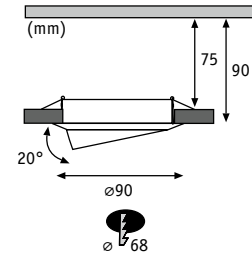

Base LED GU10 230V

Metall Métal Metaal

**Weiß Blanc Witw**



incl. 1x4,6W | 410lm | GU10 | 3.000 K |  $\sphericalangle$ 38° | EAN 4000870 934111 **934.11**

incl. 3x4,6W | 3x410lm | GU10 | 3.000 K |  $\sphericalangle$ 38° | EAN 4000870 934227 **934.22**

incl. 3x5W | 3x350lm | GU10 | 3.000 K |  $\sphericalangle$ 38° | EAN 4000870 934265 **934.26**

**Eisen gebürstet Acier brossé Staal geborsteld**



incl. 1x4,6W | 410lm | GU10 | 3.000 K |  $\sphericalangle$ 38° | EAN 4000870 934128 **934.12**

incl. 3x4,6W | 3x410lm | GU10 | 3.000 K |  $\sphericalangle$ 38° | EAN 4000870 934203 **934.20**

incl. 3x5W | 3x350lm | GU10 | 3.000 K |  $\sphericalangle$ 38° | EAN 4000870 934241 **934.24**

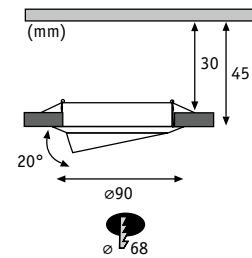

Base LED Coin 230V

Metall Métal Metaal

**Weiß Blanc Wit**



incl. 1x5W | 370lm | Coin | 3.000 K |  $\sphericalangle$ 100° | EAN 4000870 934135 **934.13**

incl. 3x5W | 3x370lm | Coin | 3.000 K |  $\sphericalangle$ 100° | EAN 4000870 934234 **934.23**

incl. 3x5W | 3x370lm | Coin | 3.000 K |  $\sphericalangle$ 100° | EAN 4000870 934272 **934.27**

**Eisen gebürstet Acier brossé Staal geborsteld**



incl. 1x5W | 370lm | Coin | 3.000 K |  $\sphericalangle$ 100° | EAN 4000870 934142 **934.14**

incl. 3x5W | 3x370lm | Coin | 3.000 K |  $\sphericalangle$ 100° | EAN 4000870 934210 **934.21**

incl. 3x5W | 3x370lm | Coin | 3.000 K |  $\sphericalangle$ 100° | EAN 4000870 934258 **934.25**

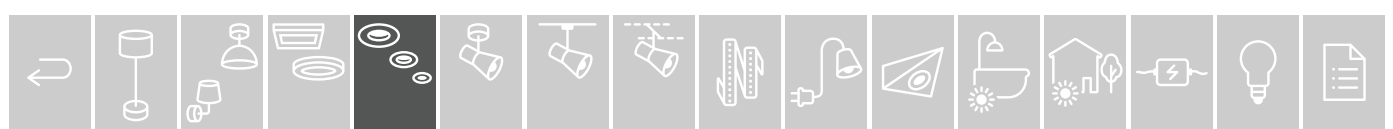



GU10



GU10 | 3 step dim

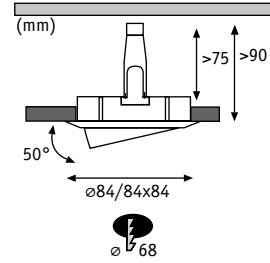

Nova LED GU10 230V

Alu Alu Alu

**Wei matt Blanc dpoli Wit mat**



	incl. 1x6,5W		460 lm		GU10		2.700 K		∠38°		EAN 4000870 934302	<b>934.30</b>
	incl. 3x6,5W		3x460 lm		GU10		2.700 K		∠38°		EAN 4000870 934319	<b>934.31</b>
	incl. 1x6,5W		460 lm		GU10		2.700 K		∠38°		EAN 4000870 934661	<b>934.66</b>
	incl. 3x6,5W		3x460 lm		GU10		2.700 K		∠38°		EAN 4000870 934678	<b>934.67</b>
	incl. 1x6,5W		460 lm		GU10		2.700 K		∠38°		EAN 4000870 934357	<b>934.35</b>
	incl. 3x6,5W		3x460 lm		GU10		2.700 K		∠38°		EAN 4000870 934364	<b>934.36</b>
	incl. 1x6,5W		460 lm		GU10		2.700 K		∠38°		EAN 4000870 934715	<b>934.71</b>
	incl. 3x6,5W		3x460 lm		GU10		2.700 K		∠38°		EAN 4000870 934722	<b>934.72</b>

**Eisen gebrstet Acier bross Staal geborsteld**



	incl. 1x6,5W		460 lm		GU10		2.700 K		∠38°		EAN 4000870 934289	<b>934.28</b>
	incl. 3x6,5W		3x460 lm		GU10		2.700 K		∠38°		EAN 4000870 934296	<b>934.29</b>
	incl. 1x6,5W		460 lm		GU10		2.700 K		∠38°		EAN 4000870 934647	<b>934.64</b>
	incl. 3x6,5W		3x460 lm		GU10		2.700 K		∠38°		EAN 4000870 934654	<b>934.65</b>

**Chrom Chrome Chrom**



	incl. 3x6,5W		3x460 lm		GU10		2.700 K		∠38°		EAN 4000870 934340	<b>934.34</b>
	incl. 3x6,5W		3x460 lm		GU10		2.700 K		∠38°		EAN 4000870 934708	<b>934.70</b>

**Alu gedreht Alu tourn Alu gedraaid**

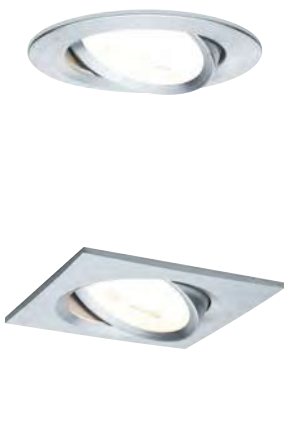

	incl. 1x6,5W		460 lm		GU10		2.700 K		∠38°		EAN 4000870 934326	<b>934.32</b>
	incl. 3x6,5W		3x460 lm		GU10		2.700 K		∠38°		EAN 4000870 934333	<b>934.33</b>
	incl. 1x6,5W		460 lm		GU10		2.700 K		∠38°		EAN 4000870 934685	<b>934.68</b>
	incl. 3x6,5W		3x460 lm		GU10		2.700 K		∠38°		EAN 4000870 934692	<b>934.69</b>
	incl. 1x6,5W		460 lm		GU10		2.700 K		∠38°		EAN 4000870 934371	<b>934.37</b>
	incl. 3x6,5W		3x460 lm		GU10		2.700 K		∠38°		EAN 4000870 934388	<b>934.38</b>
	incl. 1x6,5W		460 lm		GU10		2.700 K		∠38°		EAN 4000870 934739	<b>934.73</b>
	incl. 3x6,5W		3x460 lm		GU10		2.700 K		∠38°		EAN 4000870 934746	<b>934.74</b>



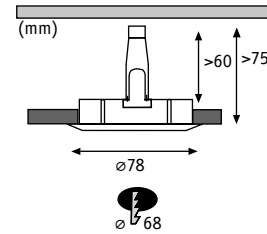

**Nova LED GU10 4000K**

Alu Zink Alu zink Alu zink

**Wei matt Blanc dpoli Wit mat**



	incl. 1x6 W		470 lm		GU10		4.000 K		36°		EAN 4000870 929780	<b>929.78</b>
	incl. 3x6 W		3x470 lm		GU10		4.000 K		36°		EAN 4000870 929803	<b>929.80</b>
	incl. 1x6 W		470 lm		GU10		4.000 K		36°		EAN 4000870 929827	<b>929.82</b>
	incl. 3x6 W		3x470 lm		GU10		4.000 K		36°		EAN 4000870 929841	<b>929.84</b>
	incl. 1x6 W		470 lm		GU10		2.700 K		38°		EAN 4000870 934418	<b>934.41</b>
	incl. 3x6 W		3x470 lm		GU10		2.700 K		38°		EAN 4000870 934425	<b>934.42</b>
	incl. 1x6 W		470 lm		GU10		2.700 K		38°		EAN 4000870 934777	<b>934.77</b>
	incl. 3x6 W		3x470 lm		GU10		2.700 K		38°		EAN 4000870 934784	<b>934.78</b>

**Eisen gebrstet Acier bros Staal geborsteld**



	incl. 1x6 W		470 lm		GU10		4.000 K		36°		EAN 4000870 929773	<b>929.77</b>
	incl. 3x6 W		3x470 lm		GU10		4.000 K		36°		EAN 4000870 929797	<b>929.79</b>
	incl. 1x6 W		470 lm		GU10		4.000 K		36°		EAN 4000870 929810	<b>929.81</b>
	incl. 3x6 W		3x470 lm		GU10		4.000 K		36°		EAN 4000870 929834	<b>929.83</b>
	incl. 1x6 W		470 lm		GU10		2.700 K		38°		EAN 4000870 934395	<b>934.39</b>
	incl. 3x6 W		3x470 lm		GU10		2.700 K		38°		EAN 4000870 934401	<b>934.40</b>
	incl. 1x6 W		470 lm		GU10		2.700 K		38°		EAN 4000870 934753	<b>934.75</b>
	incl. 3x6 W		3x470 lm		GU10		2.700 K		38°		EAN 4000870 934760	<b>934.76</b>

**Chrom Chrome Chrom**



	incl. 3x6 W		3x470 lm		GU10		2.700 K		38°		EAN 4000870 934456	<b>934.45</b>
	incl. 3x6 W		3x470 lm		GU10		2.700 K		38°		EAN 4000870 934814	<b>934.81</b>

**Alu gedreht Alu tourn Alu gedraaid**



	incl. 1x6 W		470 lm		GU10		2.700 K		38°		EAN 4000870 934432	<b>934.43</b>
	incl. 3x6 W		3x470 lm		GU10		2.700 K		38°		EAN 4000870 934449	<b>934.44</b>
	incl. 1x6 W		470 lm		GU10		2.700 K		38°		EAN 4000870 934791	<b>934.79</b>
	incl. 3x6 W		3x470 lm		GU10		2.700 K		38°		EAN 4000870 934807	<b>934.80</b>



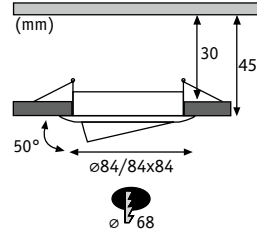

Nova LED Coin 230V

Alu Alu Alu

**Weiß matt Blanc dépoli Wit mat**



incl. 1x6 W	470 lm	Coin	2.700 K	◊100°	EAN 4000870 934487	<b>934.48</b>
incl. 3x6 W	3x470 lm	Coin	2.700 K	◊100°	EAN 4000870 934494	<b>934.49</b>
incl. 1x6 W	470 lm	Coin	2.700 K	◊100°	EAN 4000870 934845	<b>934.84</b>
incl. 3x6 W	3x470 lm	Coin	2.700 K	◊100°	EAN 4000870 934852	<b>934.85</b>
incl. 1x6 W	470 lm	Coin	2.700 K	◊100°	EAN 4000870 934531	<b>934.53</b>
incl. 3x6 W	3x470 lm	Coin	2.700 K	◊100°	EAN 4000870 934548	<b>934.54</b>
incl. 1x6 W	470 lm	Coin	2.700 K	◊100°	EAN 4000870 934890	<b>934.89</b>
incl. 3x6 W	3x470 lm	Coin	2.700 K	◊100°	EAN 4000870 934906	<b>934.90</b>

**Eisen gebürstet Acier brossé Staal geborsteld**



incl. 1x6 W	470 lm	Coin	2.700 K	◊100°	EAN 4000870 934463	<b>934.46</b>
incl. 3x6 W	3x470 lm	Coin	2.700 K	◊100°	EAN 4000870 934470	<b>934.47</b>
incl. 1x6 W	470 lm	Coin	2.700 K	◊100°	EAN 4000870 934821	<b>934.82</b>
incl. 3x6 W	3x470 lm	Coin	2.700 K	◊100°	EAN 4000870 934838	<b>934.83</b>

**Chrom Chrome Chrom**



incl. 3x6 W	3x470 lm	Coin	2.700 K	◊100°	EAN 4000870 934524	<b>934.52</b>
incl. 3x6 W	3x470 lm	Coin	2.700 K	◊100°	EAN 4000870 934883	<b>934.88</b>

**Alu gedreht Alu tourné Alu gedraaid**



incl. 1x6 W	470 lm	Coin	2.700 K	◊100°	EAN 4000870 934500	<b>934.50</b>
incl. 3x6 W	3x470 lm	Coin	2.700 K	◊100°	EAN 4000870 934517	<b>934.51</b>
incl. 1x6 W	470 lm	Coin	2.700 K	◊100°	EAN 4000870 934869	<b>934.86</b>
incl. 3x6 W	3x470 lm	Coin	2.700 K	◊100°	EAN 4000870 934876	<b>934.87</b>
incl. 1x6 W	470 lm	Coin	2.700 K	◊100°	EAN 4000870 934555	<b>934.55</b>
incl. 3x6 W	3x470 lm	Coin	2.700 K	◊100°	EAN 4000870 934562	<b>934.56</b>
incl. 1x6 W	470 lm	Coin	2.700 K	◊100°	EAN 4000870 934913	<b>934.91</b>
incl. 3x6 W	3x470 lm	Coin	2.700 K	◊100°	EAN 4000870 934920	<b>934.92</b>

**Schwarz matt Noir mat Zwart mat**



incl. 3x6 W	3x470 lm	Coin	2.700 K	◊100°	EAN 4000870 944714	<b>944.71</b>
incl. 3x6 W	3x470 lm	Coin	2.700 K	◊100°	EAN 4000870 944721	<b>944.72</b>





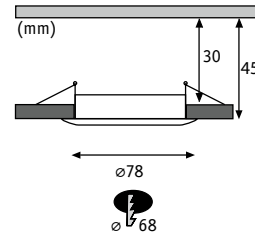

Nova LED Coin 230V

Alu Alu Alu

**Wei matt Blanc dpoli Wit mat**



incl. 1x6 W		470 lm		Coin		2.700 K		100 °		EAN 4000870 934593	<b>934.59</b>
incl. 3x6 W		3x470 lm		Coin		2.700 K		100 °		EAN 4000870 934609	<b>934.60</b>
incl. 1x6 W		470 lm		Coin		2.700 K		100 °		EAN 4000870 934951	<b>934.95</b>
incl. 3x6 W		3x470 lm		Coin		2.700 K		100 °		EAN 4000870 934968	<b>934.96</b>

**Eisen gebrstet Acier bross Staal geborsteld**



incl. 1x6 W		470 lm		Coin		2.700 K		100 °		EAN 4000870 934579	<b>934.57</b>
incl. 3x6 W		3x470 lm		Coin		2.700 K		100 °		EAN 4000870 934586	<b>934.58</b>
incl. 1x6 W		470 lm		Coin		2.700 K		100 °		EAN 4000870 934937	<b>934.93</b>
incl. 3x6 W		3x470 lm		Coin		2.700 K		100 °		EAN 4000870 934944	<b>934.94</b>

**Chrom Chrome Chrom**



incl. 3x6 W		3x470 lm		Coin		2.700 K		100 °		EAN 4000870 934630	<b>934.63</b>
incl. 3x6 W		3x470 lm		Coin		2.700 K		100 °		EAN 4000870 934999	<b>934.99</b>

**Alu gedreht Alu tourn Alu gedraaid**



incl. 1x6 W		470 lm		Coin		2.700 K		100 °		EAN 4000870 934616	<b>934.61</b>
incl. 3x6 W		3x470 lm		Coin		2.700 K		100 °		EAN 4000870 934623	<b>934.62</b>
incl. 1x6 W		470 lm		Coin		2.700 K		100 °		EAN 4000870 934975	<b>934.97</b>
incl. 3x6 W		3x470 lm		Coin		2.700 K		100 °		EAN 4000870 934982	<b>934.98</b>

**Schwarz matt Noir mat Zwart mat**



incl. 3x6 W		3x470 lm		Coin		2.700 K		100 °		EAN 4000870 944738	<b>944.73</b>
incl. 3x6 W		3x470 lm		Coin		2.700 K		100 °		EAN 4000870 944745	<b>944.74</b>



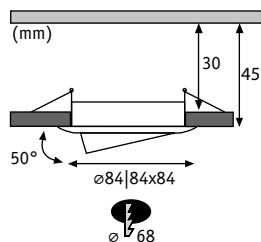

## LED 230V Slim Coin Satin 51mm dimmable

Alu Zink | Alu zinc | Alu zink

- ▶ Geringe Mindesteinbautiefe
- ▶ Inkl. Anschlussbox mit Doppelschnellklemme zum Durchschleifen
- ▶ Faible profondeur d'encastrement
- ▶ Boîte raccord avec double clip de fixation rapide pour la connexion du câble incluse
- ▶ Geringe minimale inbouwdiepte
- ▶ Inclusief aansluitbox met dubbele snelklem voor aankoppeling van de kabel

## Weiß matt | Blanc dépoli | Wit mat



	incl. 1x6 W		470 lm		Coin		2.700 K		EAN 4000870 938768		<b>938.76</b>
	incl. 3x6 W		3x470 lm		Coin		2.700 K		EAN 4000870 938751		<b>938.75</b>
	incl. 1x6 W		470 lm		Coin		2.700 K		EAN 4000870 936771		<b>936.77</b>
	incl. 3x6 W		3x470 lm		Coin		2.700 K		EAN 4000870 936788		<b>936.78</b>

## Eisen gebürstet | Acier brossé | Staal geborsteld



	incl. 1x6 W		470 lm		Coin		2.700 K		EAN 4000870 938775		<b>938.77</b>
	incl. 3x6 W		3x470 lm		Coin		2.700 K		EAN 4000870 938782		<b>938.78</b>

## Chrom | Chrome | Chroom



	incl. 1x6 W		470 lm		Coin		2.700 K		EAN 4000870 938799		<b>938.79</b>
	incl. 3x6 W		3x470 lm		Coin		2.700 K		EAN 4000870 938805		<b>938.80</b>

## Alu gedreht | Alu tourné | Alu gedraaid



	incl. 1x6 W		470 lm		Coin		2.700 K		EAN 4000870 939024		<b>939.02</b>
	incl. 3x6 W		3x470 lm		Coin		2.700 K		EAN 4000870 939031		<b>939.03</b>
	incl. 1x6 W		470 lm		Coin		2.700 K		EAN 4000870 936795		<b>936.79</b>
	incl. 3x6 W		3x470 lm		Coin		2.700 K		EAN 4000870 936801		<b>936.80</b>

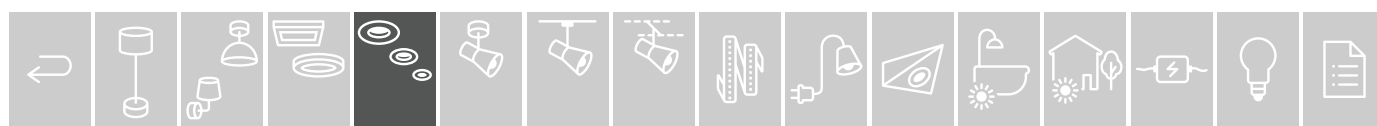

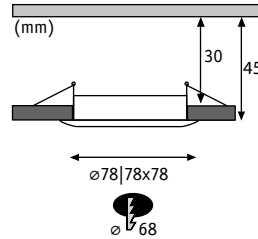

**LED 230V Slim Coin Satin 51mm dimmable**

Alu Zink Alu zinc Alu zink

- ▶ Geringe Mindesteinbautiefe
- ▶ Inkl. Anschlussbox mit Doppelschnellklemme zum Durchschleifen
- ▶ Faible profondeur d'encastrement
- ▶ Boîte raccord avec double clip de fixation rapide pour la connexion du câble incluse
- ▶ Geringe minimale inbouwdiepte
- ▶ Inclusief aansluitbox met dubbele snelklem voor aankoppeling van de kabel

**Wei matt Blanc dpoli Wit mat**



	incl. 1x6 W		470 lm		Coin		2.700 K		EAN 4000870 938690	<b>938.69</b>
	incl. 3x6 W		3x470 lm		Coin		2.700 K		EAN 4000870 938706	<b>938.70</b>

**Eisen gebrstet Acier bross Staal geborsteld**



	incl. 1x6 W		470 lm		Coin		2.700 K		EAN 4000870 938713	<b>938.71</b>
	incl. 3x6 W		3x470 lm		Coin		2.700 K		EAN 4000870 938737	<b>938.73</b>

**Chrom Chrome Chrom**



	incl. 1x6 W		470 lm		Coin		2.700 K		EAN 4000870 938720	<b>938.72</b>
	incl. 3x6 W		3x470 lm		Coin		2.700 K		EAN 4000870 938744	<b>938.74</b>

**Alu gedreht Alu tourn Alu gedraaid**



	incl. 1x6 W		470 lm		Coin		2.700 K		EAN 4000870 939000	<b>939.00</b>
	incl. 3x6 W		3x470 lm		Coin		2.700 K		EAN 4000870 939017	<b>939.01</b>

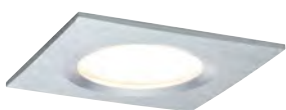

	incl. 3x6 W		3x470 lm		Coin		2.700 K		EAN 4000870 938959	<b>938.95</b>
--	-------------	--	----------	--	------	--	---------	--	--------------------	---------------



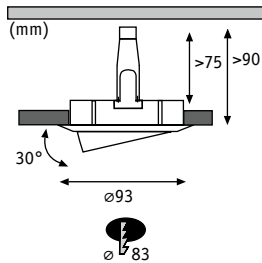

GU10 | dimmable | IP65

**Nova IP65 adjustable GU10 dimmable**

Alu Zink Alu zinc Alu zink

**Wei matt Blanc dpoli Wit mat**



	incl. 1x6 W		470 lm		GU10		2.700 K		36°	EAN 4000870 928974		<b>928.97</b>
	incl. 3x6 W		3x470 lm		GU10		2.700 K		36°	EAN 4000870 928981		<b>928.98</b>

**Eisen gebrstet Acier bross Staal geborsteld**



	incl. 1x6 W		470 lm		GU10		2.700 K		36°	EAN 4000870 928998		<b>928.99</b>
	incl. 3x6 W		3x470 lm		GU10		2.700 K		36°	EAN 4000870 929001		<b>929.00</b>

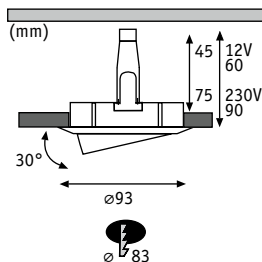

IP65



**Nova IP65 adjustable GU10/GU5,3**

Alu Zink Alu zinc Alu zink

**Wei matt Blanc dpoli Wit mat**



max. 35 W		GU5,3 / GU10	EAN 4000870 936610	<b>936.61</b>
-----------	--	--------------	--------------------	---------------

**Eisen gebrstet Acier bross Staal geborsteld**



max. 35 W		GU5,3 / GU10	EAN 4000870 936627	<b>936.62</b>
-----------	--	--------------	--------------------	---------------

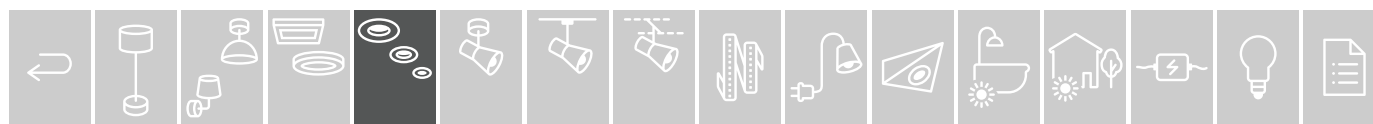

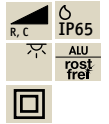
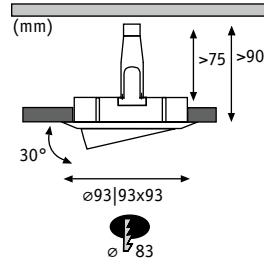

**Nova IP65 adjustable GU10 dimmable**

Alu Zink Alu zinc Alu zink

- Spritz- und Strahlwassergeschützt (IP65)
- Geeignet für die Installation im Bad
- Protection contre les projections d'eau et les jets d'eau (IP65)
- Convient à l'installation dans des salles de bains
- Beschermtd tegen opspattend water en waterstralen (IP65)
- Geschikt voor installatie in de badkamer

**Weiß matt/Chrom Blanc dépoli/Chrome Wit mat/Chroom**



incl. 1x6 W | 470 lm | GU10 | 2.700 K |  $\sphericalangle$ 36° | EAN 4000870 929032 | **929.03**

incl. 1x6 W | 470 lm | GU10 | 2.700 K |  $\sphericalangle$ 36° | EAN 4000870 929049 | **929.04**

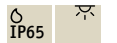
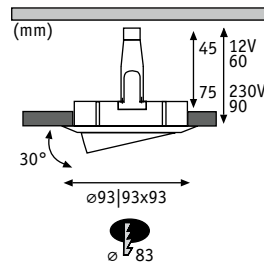

**Nova IP65 adjustable GU10/GU5,3**

Alu Zink Alu zinc Alu zink

- Spritz- und Strahlwassergeschützt (IP65)
- Geeignet für die Installation im Bad
- Protection contre les projections d'eau et les jets d'eau (IP65)
- Convient à l'installation dans des salles de bains
- Beschermtd tegen opspattend water en waterstralen (IP65)
- Geschikt voor installatie in de badkamer

**Weiß matt/Chrom Blanc dépoli/Chrome Wit mat/Chroom**



max. 35 W | GU5,3 / GU10 | EAN 4000870 936634 | **936.63**

max. 35 W | GU5,3 / GU10 | EAN 4000870 936641 | **936.64**



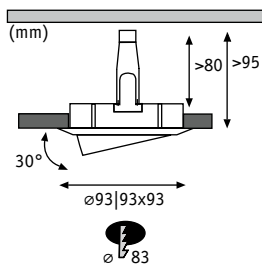

**Nova Plus IP65** Alu Zink Alu zinc Alu zink

**Wei matt Blanc dpoli Wit mat**



incl. 1x6 W | 470 lm | GU10 | 4.000 K |  $\sphericalangle$ 36° | EAN 4000870 936726 | **936.72**

**Eisen gebrstet Acier bross Staal geborsteld**



incl. 1x6 W | 470 lm | GU10 | 4.000 K |  $\sphericalangle$ 36° | EAN 4000870 936719 | **936.71**

**Wei matt/Chrom Blanc dpoli/Chrome Wit mat/Chroom**



incl. 1x6 W | 470 lm | GU10 | 4.000 K |  $\sphericalangle$ 36° | EAN 4000870 936733 | **936.73**



incl. 1x6 W | 470 lm | GU10 | 4.000 K |  $\sphericalangle$ 36° | EAN 4000870 936740 | **936.74**

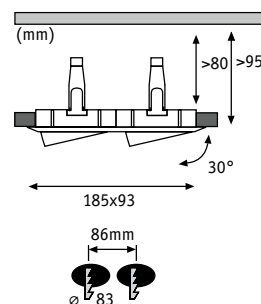

**Nova Plus IP65** Alu Zink Alu zinc Alu zink

**Wei matt/Chrom Blanc dpoli/Chrome Wit mat/Chroom**



incl. 1x 2x6 W | 1x | 2x470 lm | GU10 | 4.000 K |  $\sphericalangle$ 36° | EAN 4000870 936757 | **936.75**



incl. 1x 2x6 W | 1x | 2x470 lm | GU10 | 4.000 K |  $\sphericalangle$ 36° | EAN 4000870 936764 | **936.76**

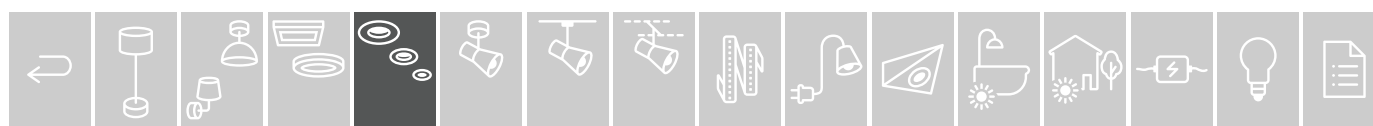

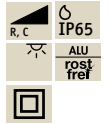
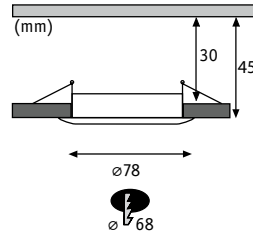

**LED IP65 230V Slim Coin Satin 51mm dimmable**

Alu Zink Alu zinc Alu zink

- ▶ Geringe Mindesteinbautiefe
- ▶ Mit Schutzglas
- ▶ Inkl. Anschlussbox mit Doppelschnellklemme zum Durchschleifen
- ▶ Faible profondeur d'encastrement
- ▶ Avec verre de protection
- ▶ Boîte raccord avec double clip de fixation rapide pour la connexion du câble incluse
- ▶ Geringe minimale inbouwdiepte
- ▶ Met beveiligingsglas
- ▶ Inclusief aansluitbox met dubbele snelklem voor aankoppeling van de kabel

**🔧 Weiß matt Blanc dépoli Wit mat**



 incl. 1x6W | 470 lm | Coin | 2.700K EAN 4000870 938812 **938.81**

**🔧 Eisen gebürstet Acier brossé Staal geborsteld**



 incl. 1x6W | 470 lm | Coin | 2.700K EAN 4000870 938829 **938.82**

**🔧 Chrom Chrome Chrom**



 incl. 1x6W | 470 lm | Coin | 2.700K EAN 4000870 938836 **938.83**



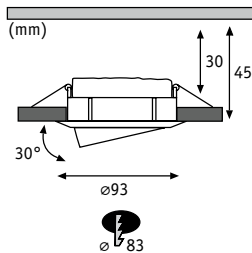

**Nova Plus Coin IP65 adjustable dimmable** Aluminium Aluminium Aluminium

**Wei matt Blanc dpoli Wit mat**



	incl. 1x6 W		470 lm		Coin		2.700 K	EAN 4000870 936818		<b>936.81</b>
	incl. 3x6 W		3x470 lm		Coin		2.700 K	EAN 4000870 936825		<b>936.82</b>

**Chrom Chrome Chrom**



	incl. 1x6 W		470 lm		Coin		2.700 K	EAN 4000870 936832		<b>936.83</b>
	incl. 3x6 W		3x470 lm		Coin		2.700 K	EAN 4000870 936849		<b>936.84</b>

**Wei matt/Chrom Blanc dpoli/Chrome Wit mat/Chrom**



	incl. 1x6 W		470 lm		Coin		2.700 K	EAN 4000870 936856		<b>936.85</b>
	incl. 3x6 W		3x470 lm		Coin		2.700 K	EAN 4000870 936863		<b>936.86</b>

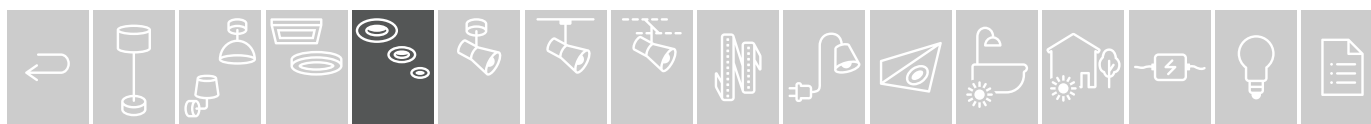



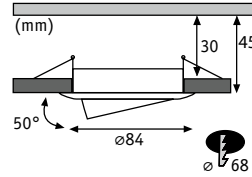
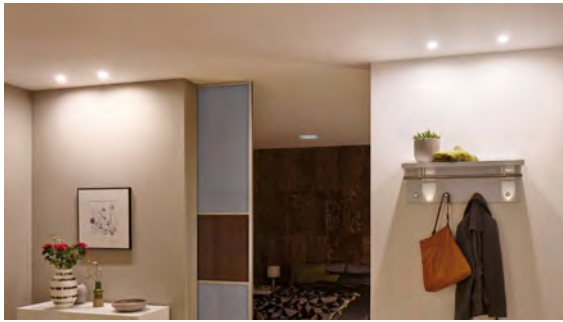

dimmable  
 smart controllable  
 zigbee



**Nova Plus Zigbee Coin dim**

Alu Zink Alu zinc Alu zink

Eisen gebürstet Acier brossé Staal geborsteld



	incl. 1x6 W		470 lm		Coin		2.700 K		◊100°	EAN 4000870 929582	<b>929.58</b>
	incl. 3x6 W		3x470 lm		Coin		2.700 K		◊100°	EAN 4000870 929599	<b>929.59</b>

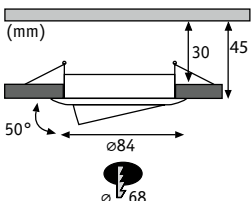

tunable white  
 smart controllable  
 zigbee

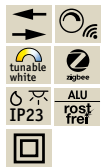

**Nova Plus Zigbee Coin tunable white**

Alu Zink Alu zinc Alu zink

Eisen gebürstet Acier brossé Staal geborsteld



	incl. 1x6 W		470 lm		Coin		2.700 - 6.500 K		◊100°	EAN 4000870 929612	<b>929.61</b>
	incl. 3x6 W		3x470 lm		Coin		2.700 - 6.500 K		◊100°	EAN 4000870 929629	<b>929.62</b>

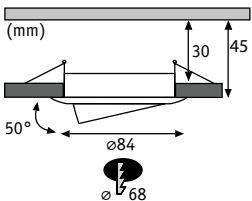

RGBW  
 smart controllable  
 zigbee



**Nova Plus Zigbee Coin RGBW**

Alu Zink Alu zinc Alu zink

Eisen gebürstet Acier brossé Staal geborsteld



	incl. 1x5,2 W		400 lm		Coin		2.700 K		◊100°	EAN 4000870 929643	<b>929.64</b>
	incl. 3x5,2 W		3x400 lm		Coin		2.700 K		◊100°	EAN 4000870 929650	<b>929.65</b>



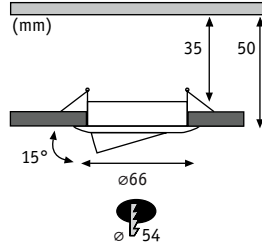

**Nova mini Coin**

Aluminium Aluminium Aluminium

**Wei matt Blanc dpoli Wit mat**



incl. 1x4 W		310 lm		Coin		2.700 K		∠38 °		EAN 4000870 942925	📦	<b>942.92</b>
incl. 3x4 W		3x310 lm		Coin		2.700 K		∠38 °		EAN 4000870 942932		<b>942.93</b>

**Eisen gebrstet Acier bross Staal geborsteld**



incl. 1x4 W		310 lm		Coin		2.700 K		∠38 °		EAN 4000870 942949	📦	<b>942.94</b>
incl. 3x4 W		3x310 lm		Coin		2.700 K		∠38 °		EAN 4000870 942956		<b>942.95</b>

**Alu gedreht Alu tourn Alu gedraaid**



incl. 1x4 W		310 lm		Coin		2.700 K		∠38 °		EAN 4000870 942963	📦	<b>942.96</b>
incl. 3x4 W		3x310 lm		Coin		2.700 K		∠38 °		EAN 4000870 942970		<b>942.97</b>

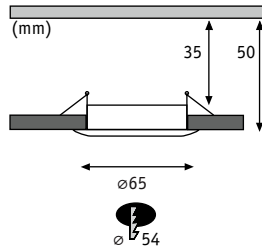

**Nova mini Coin IP44**

Aluminium Aluminium Aluminium

**Wei matt Blanc dpoli Wit mat**



incl. 1x4 W		310 lm		Coin		2.700 K		∠38 °		EAN 4000870 942987	📦	<b>942.98</b>
incl. 3x4 W		3x310 lm		Coin		2.700 K		∠38 °		EAN 4000870 942994		<b>942.99</b>

**Eisen gebrstet Acier bross Staal geborsteld**



incl. 1x4 W		310 lm		Coin		2.700 K		∠38 °		EAN 4000870 943007	📦	<b>943.00</b>
incl. 3x4 W		3x310 lm		Coin		2.700 K		∠38 °		EAN 4000870 943014		<b>943.01</b>

**Chrom Chrome Chrom**



incl. 1x4 W		310 lm		Coin		2.700 K		∠38 °		EAN 4000870 943021	📦	<b>943.02</b>
incl. 3x4 W		3x310 lm		Coin		2.700 K		∠38 °		EAN 4000870 943038		<b>943.03</b>

**Alu gedreht Alu tourn Alu gedraaid**



incl. 1x4 W		310 lm		Coin		2.700 K		∠38 °		EAN 4000870 943045	📦	<b>943.04</b>
incl. 3x4 W		3x310 lm		Coin		2.700 K		∠38 °		EAN 4000870 943052		<b>943.05</b>



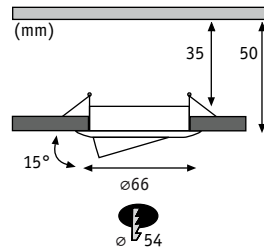

**Nova mini Coin**

Aluminium Aluminium Aluminium

**Wei matt Blanc dpoli Wit mat**



	incl. 1x4,2W		300lm		Coin		2.700K		∠38°	EAN 4000870 929704		<b>929.70</b>
	incl. 3x4,2W		3x300lm		Coin		2.700K		∠38°	EAN 4000870 929711		<b>929.71</b>

**Eisen gebrstet Acier bross Staal geborsteld**



	incl. 1x4,2W		300lm		Coin		2.700K		∠38°	EAN 4000870 929728		<b>929.72</b>
	incl. 3x4,2W		3x300lm		Coin		2.700K		∠38°	EAN 4000870 929735		<b>929.73</b>

**Alu gedreht Alu tourn Alu gedraaid**



	incl. 1x4,2W		300lm		Coin		2.700K		∠38°	EAN 4000870 929742		<b>929.74</b>
	incl. 3x4,2W		3x300lm		Coin		2.700K		∠38°	EAN 4000870 929759		<b>929.75</b>



# CHOOSE!

DE Wunsch-Einbauleuchte selbst kombinieren!

FR Combiner soi-même les spots encastrés de son choix !

NL Favoriete inbouwlampen zelf combineren!

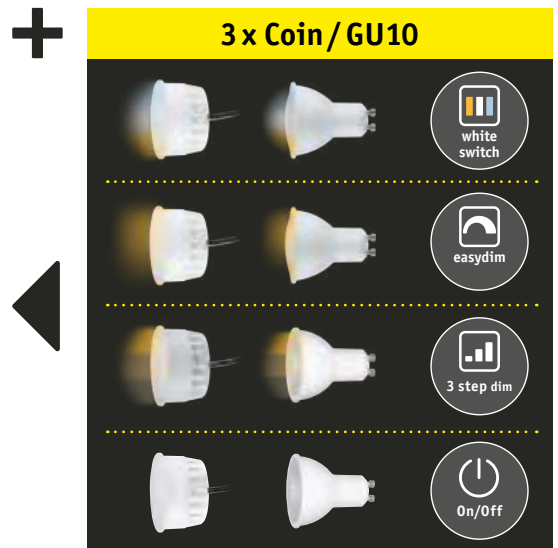

Sicher anschließen, ohne Trafo  
Raccordement sûr, sans transfo  
Veilig aansluiten, zonder trafo



Endlos verkettbar  
mit enthaltener Anschlussbox  
Raccordable à l'infini avec  
boîtier de raccordement inclus  
Eindeloos verbindbaar met  
inbegrepen aansluitbox



Bohrdurchmesser im 68 mm-  
Standard  
Diamètre de perçage standard  
68 mm  
Standaard boordiameter van  
68 mm



Haltefedern für einfachen Ein-  
und Ausbau  
Ressorts de retenue pour un  
montage et démontage faciles  
Sluitveren voor eenvoudige  
montage en demontage

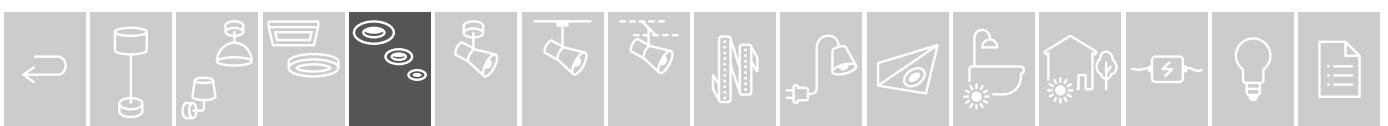

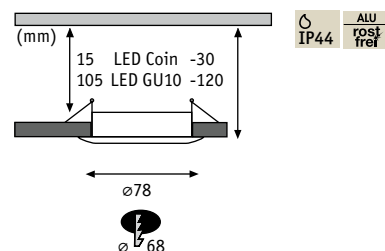
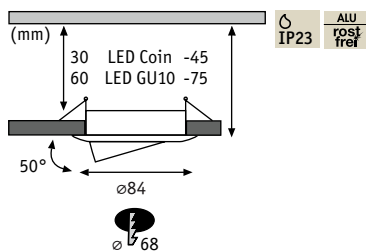

**Choose! Spot Set**

Alu Alu Alu

Wei matt Blanc dpoli Wit mat

Eisen gebrsted Acier bross Staal geborsted

Chrom Chrome Chrom



**max. 3x10W**  
EAN 4000870 924860  
**924.86**



**max. 3x10W**  
EAN 4000870 924853  
**924.85**



**max. 3x10W**  
EAN 4000870 924884  
**924.88**



**max. 3x10W**  
EAN 4000870 924808  
**924.80**



**max. 3x10W**  
EAN 4000870 924792  
**924.79**



**max. 3x10W**  
EAN 4000870 924822  
**924.82**

Alu gedreht Alu tourn Alu gedraaid

Schwarz matt Noir mat Zwart mat

Messing gebrsted Laiton bross Messing geborsted



**max. 3x10W**  
EAN 4000870 924907  
**924.90**



**max. 3x10W**  
EAN 4000870 924877  
**924.87**



**max. 3x10W**  
EAN 4000870 924891  
**924.89**



**max. 3x10W**  
EAN 4000870 924846  
**924.84**



**max. 3x10W**  
EAN 4000870 924815  
**924.81**



**max. 3x10W**  
EAN 4000870 924839  
**924.83**

**Choose! GU10 Set**

Wei Blanc Wit



On/Off



3 step dim



easy dim



white switch

**3x6,5W**  
3x460 lm, 2.700 K  
∠ 38°, 700 cd  
230V  
EAN 4000870 287842  
**287.84**

**3x6,5W**  
3x460 lm, 2.700 K  
∠ 38°, 780 cd  
230V  
EAN 4000870 287859  
**287.85**

**3x5,5W**  
3x460 lm, 2.700 K  
∠ 110°  
230V  
EAN 4000870 287866  
**287.86**

**3x5,9W**  
3x470 lm, 2.700 - 6.500 K  
∠ 110°  
230V  
EAN 4000870 287873  
**287.87**

**Choose! Coin Set**

Satin Satin Satijn



3 step dim



easy dim



white switch

**incl. 3x6W**  
3x470 lm, 2.700 K, ∠ 100°  
230V  
EAN 4000870 924723  
**924.72 new**

**incl. 3x6W**  
3x470 lm, 2.700 K, ∠ 100°  
230V  
EAN 4000870 924730  
**924.73 new**

**3x6,5W**  
3x630 lm, 2.700 K  
230V  
EAN 4000870 924778  
**924.77**

**3x6,5W**  
3x580-620 lm  
2.700 - 6.500 K, 230V  
EAN 4000870 924785  
**924.78**

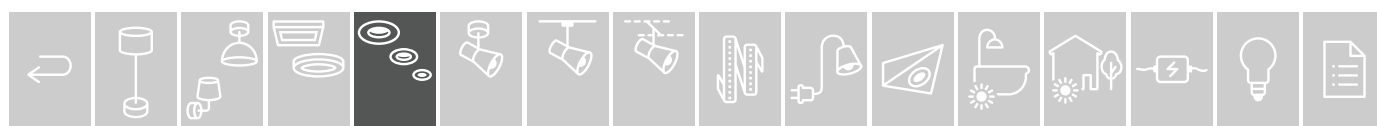

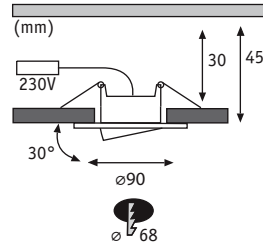
**Calla IP65**

Kunststoff Matière plastique Kunststoff

**🔧 Weiß matt Blanc dépoli Wit mat**

	incl. 1x6 W		680 lm		4.000 K		⚡100°		EAN 4000870 999264	📦	<b>999.26</b>
🔧	incl. 1x5,2 W		560 lm		4.000 K		⚡100°		EAN 4000870 999301	📦	<b>999.30</b>
	incl. 3x5,5 W		3x680 lm		4.000 K		⚡100°		EAN 4000870 999271		<b>999.27</b>
🔧	incl. 3x5,2 W		3x560 lm		4.000 K		⚡100°		EAN 4000870 999318		<b>999.31</b>
	incl. 10x6 W		10x680 lm		4.000 K		⚡100°		EAN 4000870 999226		<b>999.22</b>
🔧	incl. 10x5,2 W		10x560 lm		4.000 K		⚡100°		EAN 4000870 999240		<b>999.24</b>

**🔧 Chrom matt Chrome mat Chrom mat**

	incl. 1x6 W		680 lm		4.000 K		⚡100°		EAN 4000870 999288	📦	<b>999.28</b>
🔧	incl. 1x5,2 W		560 lm		4.000 K		⚡100°		EAN 4000870 999325	📦	<b>999.32</b>
	incl. 3x5,5 W		3x680 lm		4.000 K		⚡100°		EAN 4000870 999295		<b>999.29</b>
🔧	incl. 3x5,2 W		3x560 lm		4.000 K		⚡100°		EAN 4000870 999332		<b>999.33</b>
	incl. 10x6 W		10x680 lm		4.000 K		⚡100°		EAN 4000870 999233		<b>999.23</b>
🔧	incl. 10x5,2 W		10x560 lm		4.000 K		⚡100°		EAN 4000870 999257		<b>999.25</b>

**🔧 Schwarz matt Noir mat Zwart mat**

	incl. 3x6,5 W		3x680 lm		4.000 K		⚡100°		EAN 4000870 999912	new	<b>999.91</b>
--	---------------	--	----------	--	---------	--	-------	--	--------------------	-----	---------------



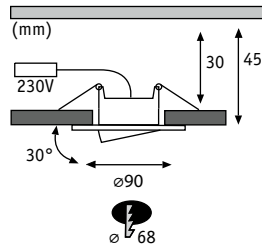

**Calla IP65** Kunststoff Matière plastique Kunststoff

**Wei matt Blanc dpoli Wit mat**



	incl. 1x5,5W		550lm		3.000 - 6.500K		∠100°	EAN 4000870 999349		<b>999.34</b>
	incl. 3x5,5W		3x550lm		3.000 - 6.500K		∠100°	EAN 4000870 999356		<b>999.35</b>

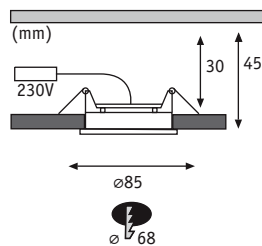

**Calla IP65** Kunststoff/Aluminium Matière plastique/Aluminium Kunststoff/Aluminium

**Wei matt Blanc dpoli Wit mat**



	incl. 1x5W		500lm		4.000K		∠100°	EAN 4000870 999363		<b>999.36</b>
--	------------	--	-------	--	--------	--	-------	--------------------	--	---------------

**Chrom matt Chrome mat Chrom mat**



	incl. 1x5W		500lm		4.000K		∠100°	EAN 4000870 999370		<b>999.37</b>
--	------------	--	-------	--	--------	--	-------	--------------------	--	---------------

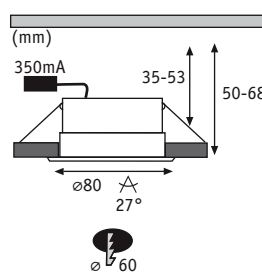

**Calla IP65** Kunststoff/Aluminium Matière plastique/Aluminium Kunststoff/Aluminium

**Wei matt Blanc dpoli Wit mat**



	incl. 1x6,7W		770lm		4.000K		∠27°		incl.	EAN 4000870 936702	<b>936.70</b>
--	--------------	--	-------	--	--------	--	------	--	-------	--------------------	---------------



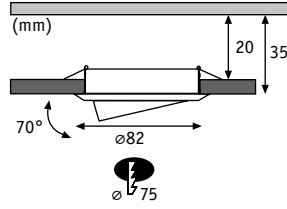

**Fixed LED Set new**

Kunststoff Matière plastique Kunststof

**Wei matt Blanc dpoli Wit mat**



incl. 3x6W | 3x580lm | 3.000K

EAN 4000870 933886

**933.88**

**Chrom matt Chrome mat Chrom mat**



incl. 3x6W | 3x580lm | 3.000K

EAN 4000870 933893

**933.89**

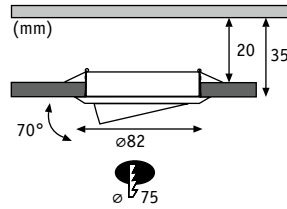

**3 step dim**

**Fixed LED Set**

Kunststoff Matière plastique Kunststof

**Wei matt Blanc dpoli Wit mat**



incl. 3x6W | 3x550lm | 3.000K |  $\sphericalangle$ 40°

EAN 4000870 929858

**929.85**

**Chrom matt Chrome mat Chrom mat**



incl. 3x6W | 3x550lm | 3.000K |  $\sphericalangle$ 40°

EAN 4000870 929865

**929.86**





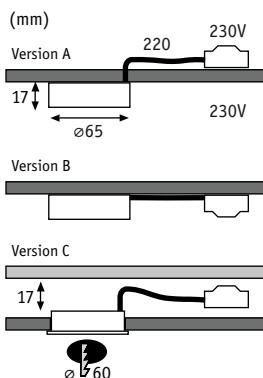

**Pukk LED Set**

☒ Kunststoff Matière plastique Kunststof

**👉 Weiß Blanc Wit**



incl. 3x3,5 W | 3x300 lm | 2.700 K

EAN 4000870 999899

**999.89**

**👉 Schwarz Noir Zwart**



incl. 3x3,5 W | 3x300 lm | 2.700 K

EAN 4000870 999905

**999.90**

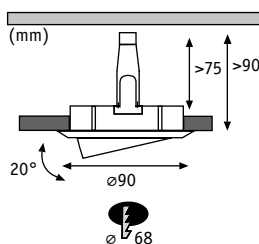

**230V GU10 51mm**

☒ Metall Métal Metaal

**👉 Weiß Blanc Wit**



max. 3x10 W | GU10

EAN 4000870 933909

**933.90**

max. 10x10 W | GU10

EAN 4000870 934005

**934.00**

**👉 Eisen gebürstet Acier brossé Staal geborsteld**



max. 3x10 W | GU10

EAN 4000870 933916

**933.91**

max. 10x10 W | GU10

EAN 4000870 933992

**933.99**

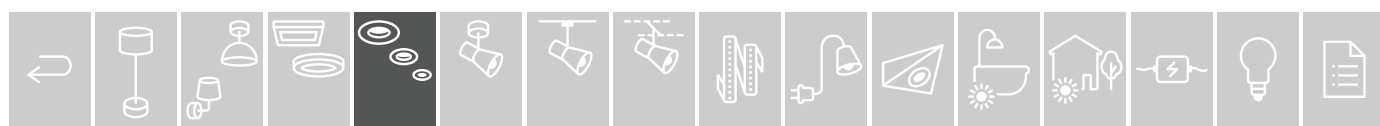

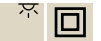
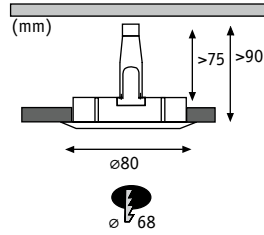

230V GU10 51mm

Metall Métal Metaal

**Wei Blanc Wit**



max. 3x10W

| GU10

EAN 4000870 933923

**933.92**

**Eisen gebrstet Acier bross Staal geborsteld**



max. 3x10W

| GU10

EAN 4000870 933930

**933.93**

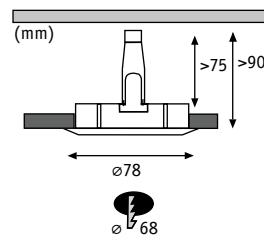

Nova 230V GU10 51mm

Alu Zink Alu zinc Alu zink

**Wei matt Blanc dpoli Wit mat**



max. 35W

| GU10

EAN 4000870 936313

**936.31**

**Eisen gebrstet Acier bross Staal geborsteld**



max. 35W

| GU10

EAN 4000870 936337

**936.33**

**Alu gedreht Alu tourn Alu gedraaid**



max. 35W

| GU10

EAN 4000870 936320

**936.32**



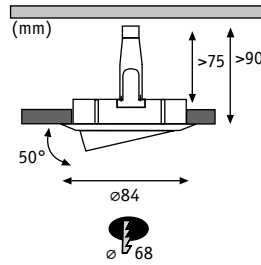

**Nova 230V GU10 51mm**

Alu Zink Alu zinc Alu zink

**Wei matt Blanc dpoli Wit mat**



max. 35 W

| GU10

EAN 4000870 936399 **936.39**

**Eisen gebrstet Acier bross Staal geborsteld**



max. 35 W

| GU10

EAN 4000870 936412 **936.41**

**Alu gedreht Alu tourn Alu gedraaid**



max. 35 W

| GU10

EAN 4000870 936405 **936.40**

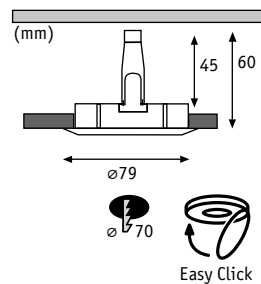

**IP44 12V GU5,3 51mm**

Alu Zink Alu zinc Alu zink

**Wei Blanc Wit**



max. 50 W

| GU5,3

EAN 4000870 179437 **179.43**

**Eisen gebrstet Acier bross Staal geborsteld**



max. 50 W

| GX5,3

EAN 4000870 179451 **179.45**

**Chrom Chrome Chroom**



max. 50 W

| GU5,3

EAN 4000870 179468 **179.46**



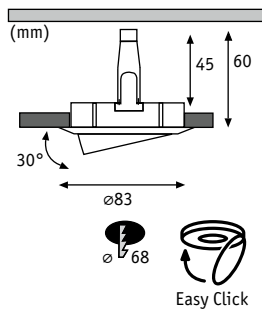

**12V GU5,3 51mm** Alu Zink Alu zinc Alu zink



**Wei Blanc Wit**

max. 50 W | GU5,3 EAN 4000870 179536 179.53



**Chrom matt Chrome mat Chrom mat**

max. 50 W | GU5,3 EAN 4000870 179543 179.54



**Eisen gebrstet Acier bross Staal geborsteld**

max. 50 W | GX5,3 EAN 4000870 179550 179.55



**Schwarz Noir Zwart**

max. 50 W | GU5,3 EAN 4000870 179512 179.51

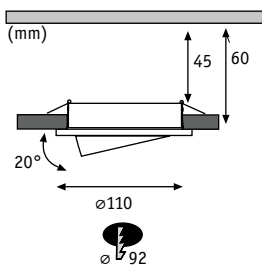

**12V GU5,3 51mm** Metall Mtal Metaal



**Wei Blanc Wit**

max. 50 W | GU5,3 EAN 4000870 989715 989.71



**Eisen gebrstet Acier bross Staal geborsteld**

max. 50 W | GU5,3 EAN 4000870 989685 989.68

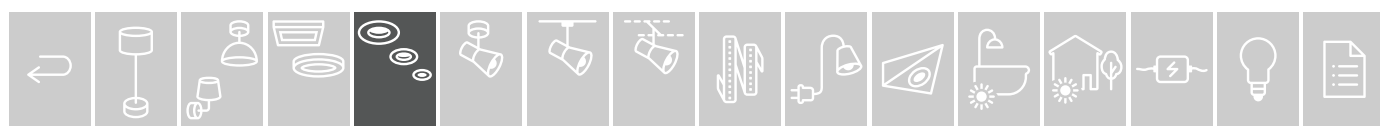

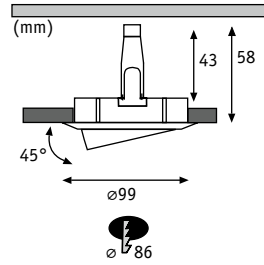

GU5,3

12V GU5,3 51mm

Alu Alu Alu

Wei Blanc Wit



max. 50W

| GU5,3

EAN 4000870 987735 987.73

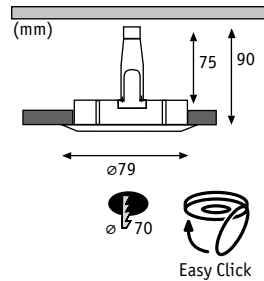

GU10



IP44 230V GU10 51mm

Alu Zink Alu zink Alu zink

Wei Blanc Wit



max. 50W

| GU10

EAN 4000870 057926 5792

Eisen gebrstet Acier bross Staal geborsteld



max. 50W

| GU10

EAN 4000870 057964 5796



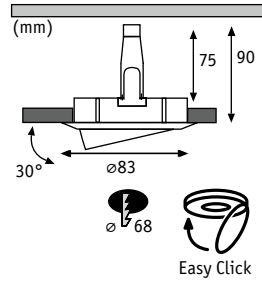

230V GU10 51mm

Alu Zink Alu zinc Alu zink

**Wei Blanc Wit**



max. 50 W

| GU10

EAN 4000870 989401

**989.40**

**Eisen gebrstet Acier bross Staal geborsteld**



max. 50 W

| GU10

EAN 4000870 988787

**988.78**

**Chrom Chrome Chroom**



max. 50 W

| GU10

EAN 4000870 989432

**989.43**

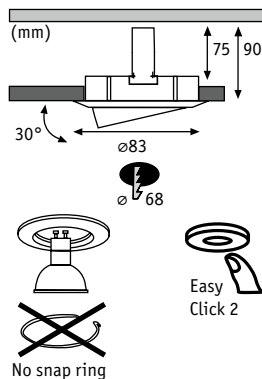

EasyClick2

Alu Zink Alu zinc Alu zink

- ▶ Kein Sprengring erforderlich
- ▶ Leuchtmittelwechsel einfach durch Druck auf das Leuchtmittel

- ▶ Aucun circlip ncessaire
- ▶ Changement d'ampoule par simple pression sur l'ampoule

- ▶ Geen klemring nodig
- ▶ Lamp wordt makkelijk vervangen door druk op de lamp

**Wei Blanc Wit**



max. 50 W

| GU10

EAN 4000870 937310

**937.31**

**Eisen gebrstet Acier bross Staal geborsteld**



max. 50 W

| GU10

EAN 4000870 937303

**937.30**





LED Coin Base



LED Coin Base 3-Step-Dim

Opal Opale Opaal

W	⊖	∅ mm	⇅ mm	lm	↘	K	⌚	📦	EAN	🏷️
<b>incl. 5</b>	Coin	51	40	370	100	3.000	15.000	1	4000870 930762	<b>new 930.76</b>

8,3 VA

Opal Opale Opaal

W	⊖	∅ mm	⇅ mm	lm	↘	K	⌚	📦	EAN	🏷️
<b>incl. 5</b>	Coin	51	40	370	100	3.000	15.000	1	4000870 930779	<b>new 930.77</b>

10,5 VA





LED Coin Nova



LED Coin Nova

Satin Satiné Satijn

W	⊖	∅ mm	⇅ mm	lm	↘	K	⌚	📦	EAN	🏷️
<b>incl. 6</b>	Coin	50	30	470	100	2.700	30.000	1	4000870 930694	<b>new 930.69</b>

Satin Satiné Satijn

W	⊖	∅ mm	⇅ mm	lm	↘	K	⌚	📦	EAN	🏷️
<b>incl. 6</b>	Coin	50	30	530	100	4.000	30.000	1	4000870 930717	<b>new 930.71</b>

12 VA





LED Coin Nova 3-Step-Dim



LED Coin Nova 3-Step-Dim

Satin Satiné Satijn

W	⊖	∅ mm	⇅ mm	lm	↘	K	⌚	📦	EAN	🏷️
<b>incl. 6</b>	Coin	50	30	470	100	2.700	30.000	1	4000870 930700	<b>new 930.70</b>

Satin Satiné Satijn

W	⊖	∅ mm	⇅ mm	lm	↘	K	⌚	📦	EAN	🏷️
<b>incl. 6</b>	Coin	50	30	530	100	4.000	30.000	1	4000870 930724	<b>new 930.72</b>

11 VA





LED Coin Nova Plus Dim



LED Coin Nova Plus Dim

Satin Satiné Satijn

W	⊖	∅ mm	⇅ mm	lm	↘	K	⌚	📦	EAN	🏷️
<b>incl. 6</b>	Coin	50	30	470	120	2.700	30.000	1	4000870 930786	<b>new 930.78</b>

Satin Satiné Satijn

W	⊖	∅ mm	⇅ mm	lm	↘	K	⌚	📦	EAN	🏷️
<b>incl. 6</b>	Coin	50	35	520	120	4.000	30.000	1	4000870 930793	<b>new 930.79</b>



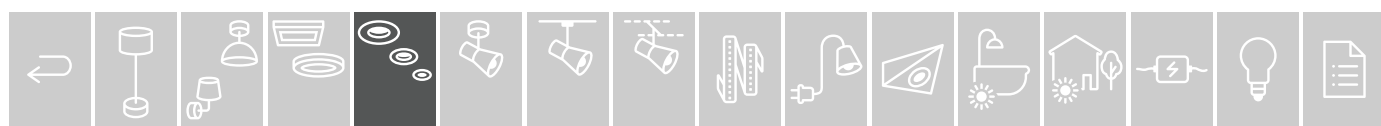



Satin Satiné Satijn

W	⊖	∅ mm	↑ mm	Lm	↘	K	⌚	📦	EAN	🏷️
<b>incl. 6,3</b>	Coin	50	30	430	38	2.700	30.000	1	4000870 924716	<b>new 92471</b>

LED Coin Nova Plus Reflector



Satin Satiné Satijn

W	⊖	∅ mm	↑ mm	Lm	↘	K	⌚	📦	EAN	🏷️
<b>incl. 6</b>	Coin	50	35	470	100	2.700	30.000	1	4000870 930731	<b>new 930.73</b>

LED Coin Nova Plus ZigBee Dim

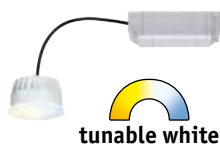

Satin Satiné Satijn

W	⊖	∅ mm	↑ mm	Lm	↘	K	⌚	📦	EAN	🏷️
<b>incl. 6</b>	Coin	50	35	470	100	2.200 - 6.500	30.000	1	4000870 930748	<b>new 930.74</b>

LED Coin Nova Plus ZigBee Tunable White



Satin Satiné Satijn

W	⊖	∅ mm	↑ mm	Lm	↘	K	⌚	📦	EAN	🏷️
<b>incl. 5,2</b>	Coin	50	35	400	100	2.700 - 6.500	30.000	1	4000870 930755	<b>new 930.75</b>

LED Coin Nova Plus ZigBee RGBW



Klar Clair Helder

W	⊖	∅ mm	↑ mm	Lm	↘	K	⌚	📦	EAN	🏷️
<b>incl. 4</b>	Coin	35	27	310	38	2.700	30.000	1	4000870 943069	<b>943.06</b>

LED Coin Nova mini



Klar Clair Helder

W	⊖	∅ mm	↑ mm	Lm	↘	K	⌚	📦	EAN	🏷️
<b>incl. 4,2</b>	Coin	35	30	300	38	2.700	30.000	1	4000870 929766	<b>929.76</b>

LED Coin Nova mini Plus EasyDim

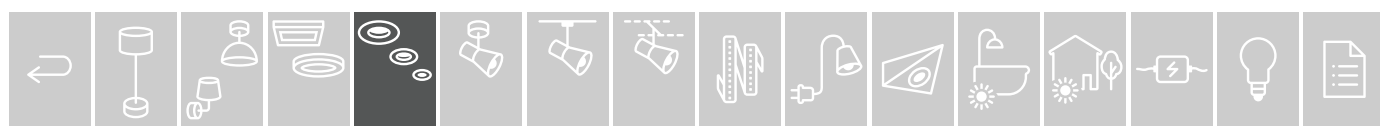

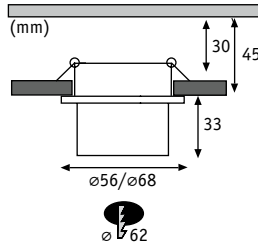

**GIL**

 GLARE FREE DESIGNER  
 RECESSED LUMINAIRES

**Gil new**

Aluminium Aluminium Aluminium

**☞ Weiß matt/Schwarz matt Blanc dépoli/Noir mat Wit mat/Zwart mat**

incl. 1x6 W		470 lm		Coin		2.700 K	EAN 4000870 933763	<b>933.76</b>
incl. 3x6 W		3x470 lm		Coin		2.700 K	EAN 4000870 933770	<b>933.77</b>

**☞ Schwarz matt/Gold Noir mat/Doré Zwart mat/Goud**

incl. 1x6 W		470 lm		Coin		2.700 K	EAN 4000870 933787	<b>933.78</b>
incl. 3x6 W		3x470 lm		Coin		2.700 K	EAN 4000870 933794	<b>933.79</b>

**☞ Weiß matt/Gold Blanc dépoli/Doré Wit mat/Goud**

incl. 1x6 W		470 lm		Coin		2.700 K	EAN 4000870 933800	<b>933.80</b>
incl. 3x6 W		3x470 lm		Coin		2.700 K	EAN 4000870 933817	<b>933.81</b>



**☞ Schwarz matt/Eisen gebürstet Noir mat/Acier brossé Zwart mat/Staal geborsteld**

incl. 1x6 W		470 lm		Coin		2.700 K	EAN 4000870 933824	<b>933.82</b>
incl. 3x6 W		3x470 lm		Coin		2.700 K	EAN 4000870 933831	<b>933.83</b>

**☞ Weiß matt/Eisen gebürstet Blanc dépoli/Acier brossé Wit mat/Staal geborsteld**

incl. 1x6 W		470 lm		Coin		2.700 K	EAN 4000870 933848	<b>933.84</b>
incl. 3x6 W		3x470 lm		Coin		2.700 K	EAN 4000870 933855	<b>933.85</b>

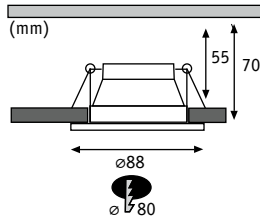





**Cole**      Kunststoff/Alu Zink Matière plastique/Alu zinc Kunststof/Alu zink

- ▶ Dekorative blendfreie Einbauleuchten mit 3Step Dimmung
- ▶ Encastrés décoratifs non éblouissant 3 niveaux de variation
- ▶ Decoratieve niet-verblindende inbouwlampen met 3-step dimfunctie



**☞ Weiß/Schwarz matt Blanc/Noir mat Wit/Zwart mat**



 incl. 1x6W		470 lm		Coin		2.700 K		◄100°		EAN 4000870 934012	 <b>934.01</b>
 incl. 3x6W		3x470 lm		Coin		2.700 K		◄100°		EAN 4000870 934029	<b>934.02</b>



**☞ Schwarz/Gold matt Noir/Doré mat Zwart/Goud mat**



 incl. 1x6W		470 lm		Coin		2.700 K		◄100°		EAN 4000870 934036	 <b>934.03</b>
 incl. 3x6W		3x470 lm		Coin		2.700 K		◄100°		EAN 4000870 934043	<b>934.04</b>



**☞ Weiß/Gold matt Blanc/Doré mat Wit/Goud mat**



 incl. 1x6W		470 lm		Coin		2.700 K		◄100°		EAN 4000870 934050	 <b>934.05</b>
 incl. 3x6W		3x470 lm		Coin		2.700 K		◄100°		EAN 4000870 934067	<b>934.06</b>



**☞ Schwarz/Silber Noir/Argent Zwart/Zilver**



 incl. 1x6W		470 lm		Coin		2.700 K		◄100°		EAN 4000870 934074	 <b>934.07</b>
 incl. 3x6W		3x470 lm		Coin		2.700 K		◄100°		EAN 4000870 934081	<b>934.08</b>

**☞ Weiß/Silber Blanc/Argent Wit/Zilver**



 incl. 1x6W		470 lm		Coin		2.700 K		◄100°		EAN 4000870 934098	 <b>934.09</b>
 incl. 3x6W		3x470 lm		Coin		2.700 K		◄100°		EAN 4000870 934104	<b>934.10</b>

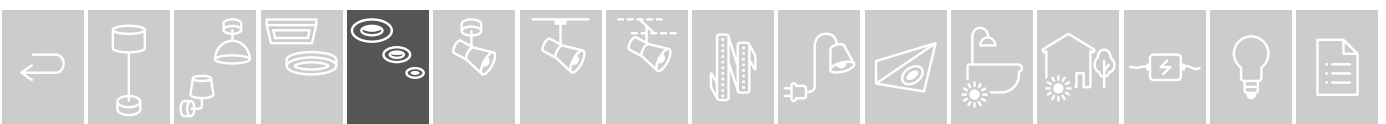

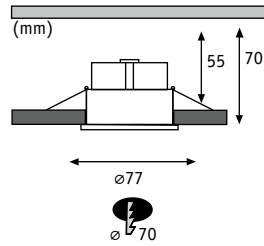

Cymbal

Kunststoff Matière plastique Kunststoff

Weiß matt Blanc dépoli Wit mat



	incl. 3x6,7W		3x440lm		Coin		2.700K		30°	EAN 4000870 934159	<b>934.15</b>
	incl. 1x6,7W		440lm		Coin		2.700K		30°	EAN 4000870 934166	<b>934.16</b>

Cymbal

Kunststoff Matière plastique Kunststoff

Weiß matt Blanc dépoli Wit mat

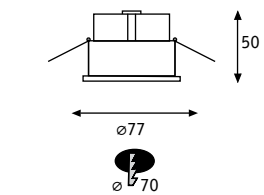
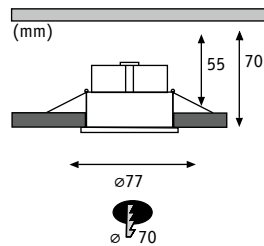
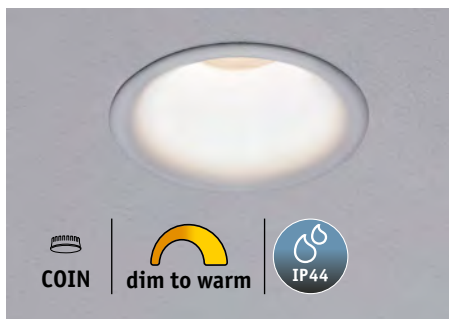

max. 10W | 440lm | 440lm  
(mm)

EAN 4000870 934173 **934.17**

Cymbal

Kunststoff Matière plastique Kunststoff

Weiß matt Blanc dépoli Wit mat



	incl. 1x6W		430lm		Coin		2.000 - 2.700K		45°	EAN 4000870 934180	<b>934.18</b>
	incl. 3x6W		3x430lm		Coin		2.000 - 2.700K		45°	EAN 4000870 934197	<b>934.19</b>



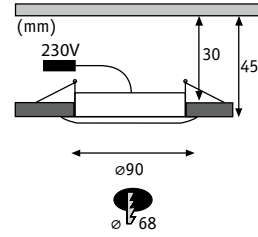

**Premium Suon 230V**

☒ Kunststoff Matière plastique Kunststoff

- ▶ Ohne Rahmen wirkt die Leuchte an der Decke unsichtbar
- ▶ Sans cadre, le luminaire au plafond est invisible
- ▶ Zonder lijst lijkt de armatuur onzichtbaar aan het plafond

🔧 **Satin/Weiß Satiné/Blanc Satijn/Wit**



🔧 incl. 1x6,5 W		650 lm		2.000 - 2.700 K	EAN 4000870 999431	📦 <b>999.43</b>
🔧 incl. 3x6,5 W		3x650 lm		2.000 - 2.700 K	EAN 4000870 999424	<b>999.42</b>



🔧 incl. 1x4,8 W		650 lm		2.700 K	EAN 4000870 999417	📦 <b>999.41</b>
🔧 incl. 3x4,8 W		3x650 lm		2.700 K	EAN 4000870 999400	<b>999.40</b>

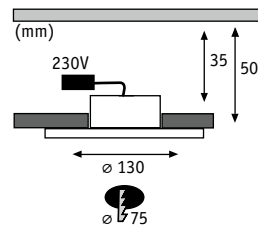

**Whirl LED new**

☒ Kunststoff Matière plastique Kunststoff

🔧 **Weiß/Klar Blanc/Clair Wit/Helder**



incl. 3x4,2 W		3x480 lm		2.700 K	EAN 4000870 933862	<b>933.86</b>
---------------	--	----------	--	---------	--------------------	---------------



incl. 3x4,2 W		3x520 lm		4.000 K	EAN 4000870 933879	<b>933.87</b>
---------------	--	----------	--	---------	--------------------	---------------



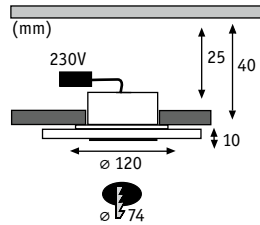

Premium Whirl 120mm dimmable

Alu/Acryl Alu/Acryl Alu/Acryl

Alu gedreht/Satin Alu tourné/Satiné Alu gedraaid/Satijn



incl. 3x4,9W | 3x460 lm | 3.000 K |  $\angle 110^\circ$  EAN 4000870 929070 **929.07**

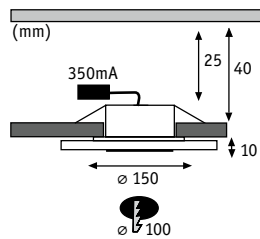

Premium Whirl LED

Alu/Acryl Alu/Acryl Alu/Acryl

Alu gedreht/Satin Alu tourné/Satiné Alu gedraaid/Satijn



incl. 1x6,9W | 655 lm | 3.000 K | | incl.  $\square$  6 VA EAN 4000870 925355 **925.35**  
 incl. 3x6,9W | 3x655 lm | 3.000 K |  $\angle 113^\circ$  | incl.  $\square$  23 VA EAN 4000870 925430 **925.43**  
 incl. 3x6,9W | 3x655 lm | 3.000 K |  $\angle 110^\circ$  | incl.  $\square$  18 VA EAN 4000870 929179 **929.17**

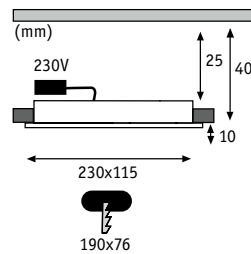

Premium Whirl oval dimmable

Alu/Acryl Alu/Acryl Alu/Acryl

Alu gedreht/Satin Alu tourné/Satiné Alu gedraaid/Satijn

incl. 1x5,8W | 680 lm | 3.000 K |  $\angle 110^\circ$  EAN 4000870 929087 **929.08**



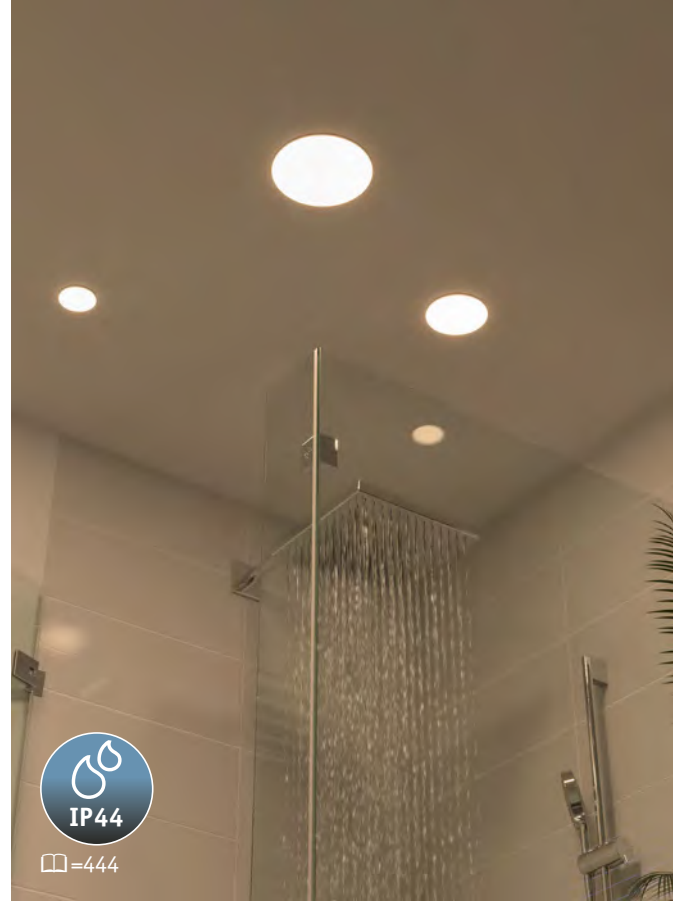

## LED Einbau-Panels

Flächiges Licht zum Einbauen

LED Panels kombinieren das flächige Raumlicht mit den Vorteilen der Einbauleuchten. Wohnliche und rahmenlose Varianten fügen sich unaufdringlich in jeden Raum ein. Ideal für den Ersatz veralteter Einbauleuchtensysteme sind Einbau-Panels mit verstellbaren Klemmfedern. Steuerbare und smarte Varianten runden das umfangreiche Sortiment optimal ab.

## Panneaux encastrés à LED

Luminaire à encastrer à distribution étendue

Les panneaux LED combinent un éclairage étendu aux avantages des spots encastrés. Des variantes conviviales et sans cadre se fondent discrètement dans n'importe quelle pièce. Les panneaux encastrés avec ressorts de serrage réglables s'avèrent idéaux pour utiliser d'anciens systèmes de spots encastrés. Les variantes pilotables et connectées parachèvent idéalement le vaste assortiment.

## LED-inbouwpanelen

Egaal licht om in te bouwen



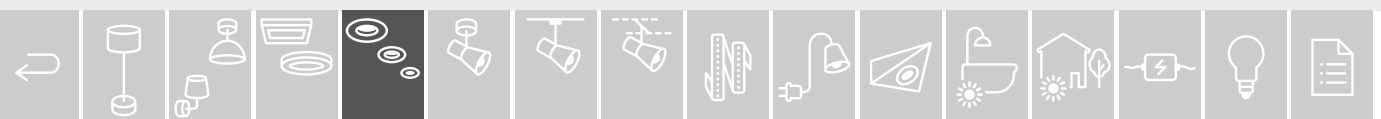

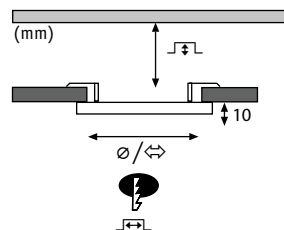
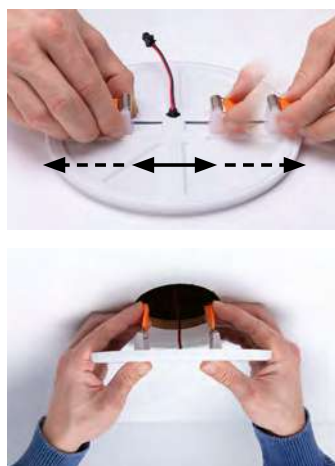

LED-panelen combineren het egale ruimtelicht met de voordelen van inbouwlampen. Huiselijke en framezonnige varianten passen zonder opvallend te zijn in elke ruimte. Inbouwpanelen met verstelbare klemveren zijn ideaal als vervanging van verouderde inbouwlampensystemen. Bestuurbare en smarte varianten ronden het omvangrijke assortiment optimaal af.











**Veluna VariFit**      Kunststoff Matière plastique Kunststof

**warm white = 3.000 K**

	<b>ø75 mm</b>	500 lm		incl. 1×4,5 W	↙↘ L45-70 mm	↙↘ L45-55 mm	EAN 4000870 923870	<b>923.87</b>
	<b>↔75 ↔75 mm</b>	500 lm		incl. 1×4,5 W	↙↘ L45-70 mm	↙↘ L45-55 mm	EAN 4000870 923931	<b>923.93</b>
	<b>ø125 mm</b>	900 lm		incl. 1×8,5 W	↙↘ L45-70 mm	↙↘ L45-100 mm	EAN 4000870 923887	<b>923.88</b>
	<b>↔125 ↔125 mm</b>	900 lm		incl. 1×8,5 W	↙↘ L45-70 mm	↙↘ L45-100 mm	EAN 4000870 923948	<b>923.94</b>
	<b>ø185 mm</b>	1.850 lm		incl. 1×17 W	↙↘ L45-70 mm	↙↘ L45-160 mm	EAN 4000870 923894	<b>923.89</b>
	<b>↔185 ↔185 mm</b>	1.850 lm		incl. 1×17 W	↙↘ L45-70 mm	↙↘ L45-160 mm	EAN 4000870 923955	<b>923.95</b>

**neutral white = 4.000 K**

	<b>ø75 mm</b>	550 lm		incl. 1×4,5 W	↙↘ L45-70 mm	↙↘ L45-55 mm	EAN 4000870 923900	<b>923.90</b>
	<b>↔75 ↔75 mm</b>	550 lm		incl. 1×4,5 W	↙↘ L45-70 mm	↙↘ L45-55 mm	EAN 4000870 923962	<b>923.96</b>
	<b>ø125 mm</b>	1.000 lm		incl. 1×8,5 W	↙↘ L45-70 mm	↙↘ L45-100 mm	EAN 4000870 923917	<b>923.91</b>
	<b>↔125 ↔125 mm</b>	1.050 lm		incl. 1×8,5 W	↙↘ L45-70 mm	↙↘ L45-100 mm	EAN 4000870 923979	<b>923.97</b>
	<b>ø185 mm</b>	1.900 lm		incl. 1×17,5 W	↙↘ L45-70 mm	↙↘ L45-160 mm	EAN 4000870 923924	<b>923.92</b>
	<b>↔185 ↔185 mm</b>	1.900 lm		incl. 1×17,5 W	↙↘ L45-70 mm	↙↘ L45-160 mm	EAN 4000870 923986	<b>923.98</b>



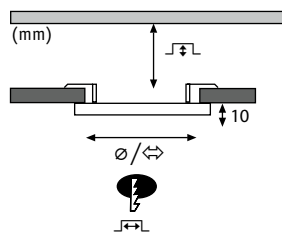
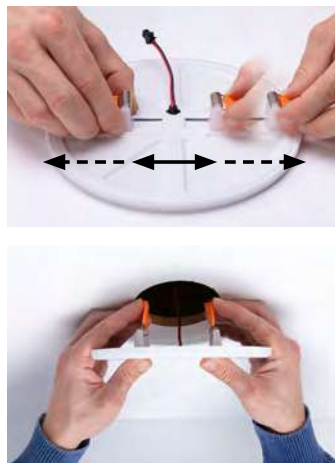

**Veluna VariFit** Kunststoff Matière plastique Kunststoff

warm white = 3.000 K – 3 step dim

	<b>ø185 mm</b>	1.860 lm		incl. 1×17 W	⌈⌋45-70 mm	⌈⌋50-160 mm	EAN 4000870 930632	<b>930.63</b>
	<b>⇔185 ⇨185 mm</b>	1.900 lm		incl. 1×17 W	⌈⌋45-70 mm	⌈⌋50-160 mm	EAN 4000870 930618	<b>930.61</b>
	<b>ø215 mm</b>	2.350 lm		incl. 1×21 W	⌈⌋45-70 mm	⌈⌋50-190 mm	EAN 4000870 930649	<b>930.64</b>
	<b>⇔215 ⇨215 mm</b>	2.400 lm		incl. 1×21 W	⌈⌋45-70 mm	⌈⌋50-190 mm	EAN 4000870 930625	<b>930.62</b>

neutral white = 4.000 K – 3 step dim

	<b>ø185 mm</b>	1.900 lm		incl. 1×17,5 W	⌈⌋45-70 mm	⌈⌋50-160 mm	EAN 4000870 930670	<b>930.67</b>
	<b>⇔185 ⇨185 mm</b>	1.950 lm		incl. 1×17,5 W	⌈⌋45-70 mm	⌈⌋50-160 mm	EAN 4000870 930656	<b>930.65</b>
	<b>ø215 mm</b>	2.450 lm		incl. 1×22 W	⌈⌋45-70 mm	⌈⌋50-190 mm	EAN 4000870 930687	<b>930.68</b>
	<b>⇔215 ⇨215 mm</b>	2.450 lm		incl. 1×22 W	⌈⌋45-70 mm	⌈⌋50-190 mm	EAN 4000870 930663	<b>930.66</b>

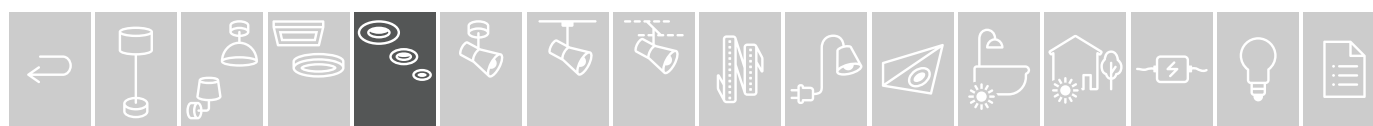



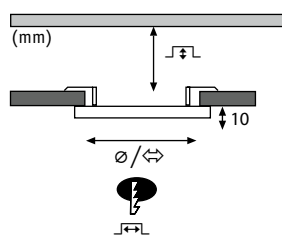
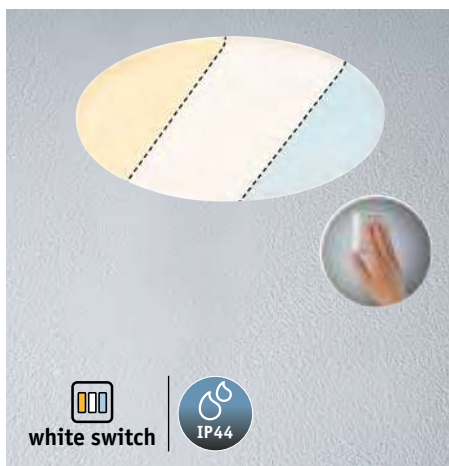
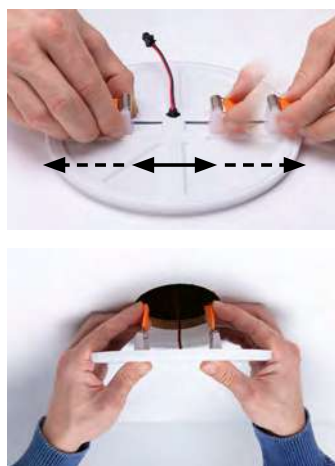

**Veluna VariFit** Kunststoff Matière plastique Kunststoff

white switch = 3.000 - 4.000 K - 6.500 K

	<b>∅185 mm</b>	1.500 lm		incl. 1×14 W	↳ 45-70 mm	↳ 60-160 mm	EAN 4000870 953815	<b>953.81</b>
	<b>⇔185 ↗185 mm</b>	1.500 lm		incl. 1×14 W	↳ 45-70 mm	↳ 60-160 mm	EAN 4000870 953792	<b>953.79</b>
	<b>∅215 mm</b>	1.900 lm		incl. 1×17 W	↳ 45-70 mm	↳ 60-190 mm	EAN 4000870 953822	<b>953.82</b>
	<b>⇔215 ↗215 mm</b>	1.900 lm		incl. 1×17 W	↳ 45-70 mm	↳ 60-190 mm	EAN 4000870 953808	<b>953.80</b>

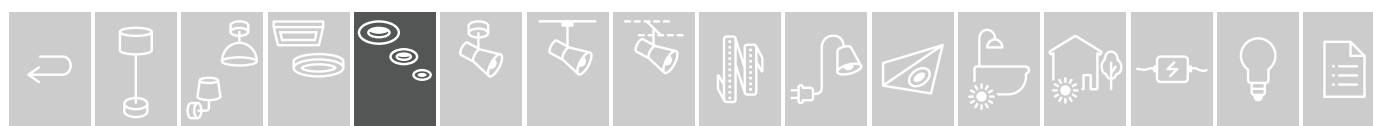

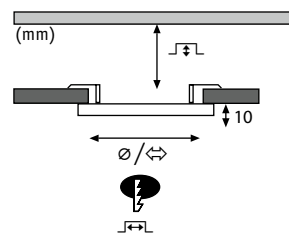
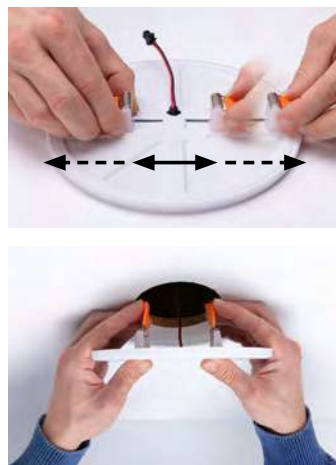





**Veluna VariFit**

☒ Kunststoff Matière plastique Kunststof

 tunable white = 3.000 - 6.500 K

	<b>ø185 mm</b>	1.600 lm		incl. 1×15 W	↳ 75-110 mm	↳ 60-160 mm	EAN 4000870 953860	<b>953.86</b>
	<b>⇔185 ⇨185 mm</b>	1.600 lm		incl. 1×15 W	↳ 75-110 mm	↳ 60-160 mm	EAN 4000870 953846	<b>953.84</b>
	<b>ø215 mm</b>	1.900 lm		incl. 1×17 W	↳ 75-110 mm	↳ 60-190 mm	EAN 4000870 953877	<b>953.87</b>
	<b>⇔215 ⇨215 mm</b>	1.900 lm		incl. 1×17 W	↳ 75-110 mm	↳ 60-190 mm	EAN 4000870 953853	<b>953.85</b>

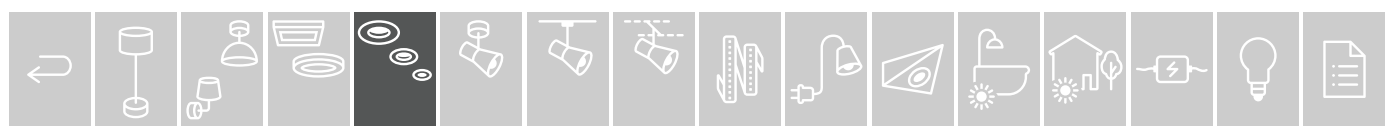

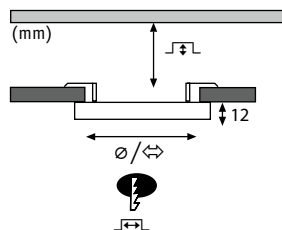
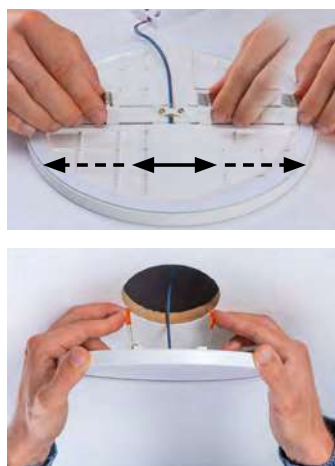

**Areo VariFit** Kunststoff Matière plastique Kunststof

● warm white = 3.000 K

**ø118 mm**



<b>W</b>	850 lm	incl. 1×6,5 W	└┐L45-95 mm	└┐L50-85 mm	EAN 4000870 930311	<b>930.31</b>
<b>CM</b>	850 lm	incl. 1×6,5 W	└┐L45-95 mm	└┐L50-85 mm	EAN 4000870 930335	<b>930.33</b>

**⇔118 ⇨118 mm**



<b>W</b>	850 lm	incl. 1×6,5 W	└┐L45-95 mm	└┐L50-85 mm	EAN 4000870 930397	<b>930.39</b>
----------	--------	---------------	-------------	-------------	--------------------	---------------

**ø175 mm**



<b>W</b>	1.800 lm	incl. 1×13 W	└┐L45-70 mm	└┐L50-140 mm	EAN 4000870 930328	<b>930.32</b>
<b>CM</b>	1.800 lm	incl. 1×13 W	└┐L45-70 mm	└┐L50-140 mm	EAN 4000870 930342	<b>930.34</b>

**⇔175 ⇨175 mm**



<b>W</b>	1.800 lm	incl. 1×13 W	└┐L45-70 mm	└┐L50-140 mm	EAN 4000870 930403	<b>930.40</b>
----------	----------	--------------	-------------	--------------	--------------------	---------------

○ neutral white = 4.000 K

**ø118 mm**



<b>W</b>	850 lm	incl. 1×6,5 W	└┐L45-95 mm	└┐L50-85 mm	EAN 4000870 930359	<b>930.35</b>
<b>CM</b>	850 lm	incl. 1×6,5 W	└┐L45-95 mm	└┐L50-85 mm	EAN 4000870 930373	<b>930.37</b>

**⇔118 ⇨118 mm**



<b>W</b>	850 lm	incl. 1×6,5 W	└┐L45-95 mm	└┐L50-85 mm	EAN 4000870 930410	<b>930.41</b>
----------	--------	---------------	-------------	-------------	--------------------	---------------

**ø175 mm**



<b>W</b>	1.800 lm	incl. 1×13 W	└┐L45-70 mm	└┐L50-140 mm	EAN 4000870 930366	<b>930.36</b>
<b>CM</b>	1.800 lm	incl. 1×13 W	└┐L45-70 mm	└┐L50-140 mm	EAN 4000870 930380	<b>930.38</b>

**⇔175 ⇨175 mm**



<b>W</b>	1.800 lm	incl. 1×13 W	└┐L45-70 mm	└┐L50-140 mm	EAN 4000870 930427	<b>930.42</b>
----------	----------	--------------	-------------	--------------	--------------------	---------------

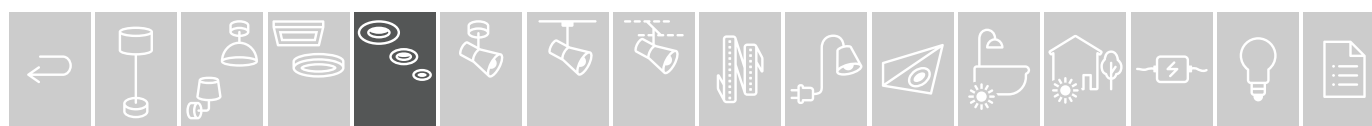

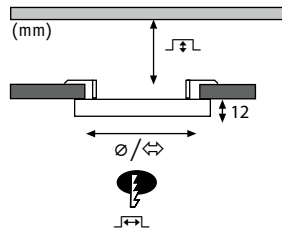
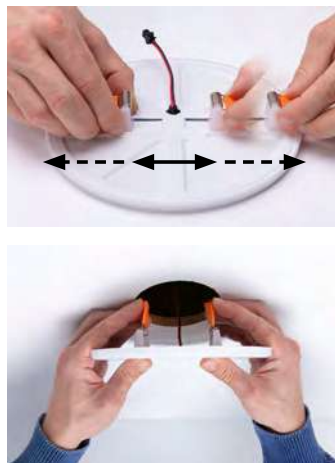

**Areo VariFit** Kunststoff Matière plastique Kunststoff

warm white = 3.000 K

**ø175 mm**

	<b>W</b>	1.800 lm	incl. 1×13 W	⇩⇩L45-70 mm	⇨⇨L50-140 mm	EAN 4000870 930496	<b>930.49</b>
	<b>CM</b>	1.800 lm	incl. 1×13 W	⇩⇩L45-70 mm	⇨⇨L50-140 mm	EAN 4000870 930519	<b>930.51</b>

**⇔175 ⇨175 mm**

	<b>W</b>	1.800 lm	incl. 1×13 W	⇩⇩L45-70 mm	⇨⇨L50-140 mm	EAN 4000870 930533	<b>930.53</b>
--	----------	----------	--------------	-------------	--------------	--------------------	---------------

**ø230 mm**

	<b>W</b>	2.200 lm	incl. 1×16 W	⇩⇩L45-70 mm	⇨⇨L50-195 mm	EAN 4000870 930502	<b>930.50</b>
	<b>CM</b>	2.200 lm	incl. 1×16 W	⇩⇩L45-70 mm	⇨⇨L50-195 mm	EAN 4000870 930526	<b>930.52</b>

**⇔230 ⇨230 mm**

	<b>W</b>	2.200 lm	incl. 1×16 W	⇩⇩L45-70 mm	⇨⇨L50-195 mm	EAN 4000870 930540	<b>930.54</b>
--	----------	----------	--------------	-------------	--------------	--------------------	---------------

neutral white = 4.000 K

**ø175 mm**

	<b>W</b>	1.800 lm	incl. 1×13 W	⇩⇩L45-70 mm	⇨⇨L50-140 mm	EAN 4000870 930557	<b>930.55</b>
	<b>CM</b>	1.800 lm	incl. 1×13 W	⇩⇩L45-70 mm	⇨⇨L50-140 mm	EAN 4000870 930571	<b>930.57</b>

**⇔175 ⇨175 mm**

	<b>W</b>	1.800 lm	incl. 1×13 W	⇩⇩L45-70 mm	⇨⇨L50-140 mm	EAN 4000870 930595	<b>930.59</b>
--	----------	----------	--------------	-------------	--------------	--------------------	---------------

**ø230 mm**

	<b>W</b>	2.200 lm	incl. 1×16 W	⇩⇩L45-70 mm	⇨⇨L50-195 mm	EAN 4000870 930564	<b>930.56</b>
	<b>CM</b>	2.200 lm	incl. 1×16 W	⇩⇩L45-70 mm	⇨⇨L50-195 mm	EAN 4000870 930588	<b>930.58</b>

**⇔230 ⇨230 mm**

	<b>W</b>	2.200 lm	incl. 1×16 W	⇩⇩L45-70 mm	⇨⇨L50-195 mm	EAN 4000870 930601	<b>930.60</b>
--	----------	----------	--------------	-------------	--------------	--------------------	---------------

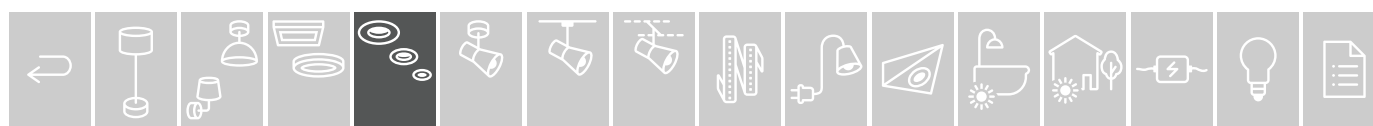

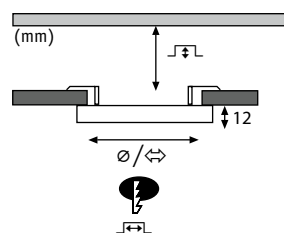
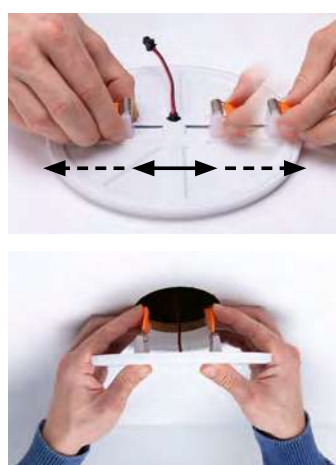

**Areo VariFit**

☒ Kunststoff Matière plastique Kunststof

☒ 3 step dim to warm = 2.000 - 4.000 K

	<b>ø175 mm</b>						
	<b>W</b>	1.700lm		incl. 1×13 W	↕45-70 mm	↕50-140 mm	EAN 4000870 929896 <b>929.89</b>
<b>CM</b>	1.700lm		incl. 1×13 W	↕45-70 mm	↕50-140 mm	EAN 4000870 929919 <b>929.91</b>	
	<b>↔175 ↗175 mm</b>						
	<b>W</b>	1.800lm		incl. 1×13 W	↕45-70 mm	↕50-140 mm	EAN 4000870 929933 <b>929.93</b>
	<b>ø230 mm</b>						
	<b>W</b>	2.000lm		incl. 1×16 W	↕45-70 mm	↕50-195 mm	EAN 4000870 929902 <b>929.90</b>
<b>CM</b>	2.000lm		incl. 1×16 W	↕45-70 mm	↕50-140 mm	EAN 4000870 929926 <b>929.92</b>	
	<b>↔230 ↗230 mm</b>						
	<b>W</b>	2.200lm		incl. 1×16 W	↕45-70 mm	↕50-195 mm	EAN 4000870 929940 <b>929.94</b>

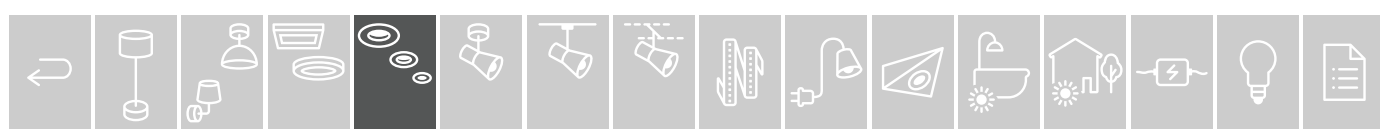

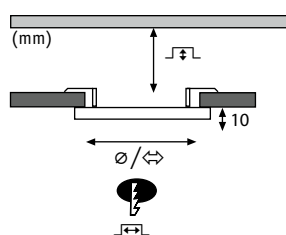
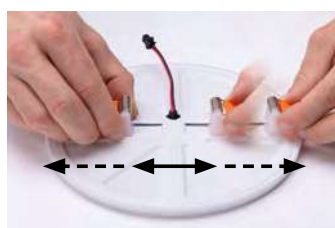

**Areo VariFit** Kunststoff Matière plastique Kunststoff

tunable white = 3.000 - 6.500 K

ø175 mm						
	1.700 lm		incl. 1×13 W	⌊L45-85 mm	⌋L50-140 mm	EAN 4000870 930434 <b>930.43</b>
	1.700 lm		incl. 1×13 W	⌊L45-85 mm	⌋L50-140 mm	EAN 4000870 930458 <b>930.45</b>
⇔175 ⇨175 mm						
	1.800 lm		incl. 1×13 W	⌊L45-85 mm	⌋L50-140 mm	EAN 4000870 930472 <b>930.47</b>
ø230 mm						
	2.000 lm		incl. 1×16 W	⌊L45-85 mm	⌋L50-195 mm	EAN 4000870 930441 <b>930.44</b>
	2.000 lm		incl. 1×16 W	⌊L45-85 mm	⌋L50-195 mm	EAN 4000870 930465 <b>930.46</b>
⇔230 ⇨230 mm						
	2.200 lm		incl. 1×16 W	⌊L45-85 mm	⌋L50-195 mm	EAN 4000870 930489 <b>930.48</b>

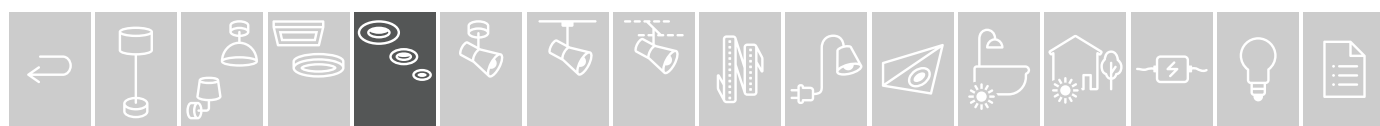

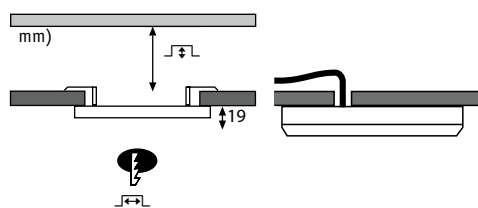







953.91/953.92  
180°  
2,5-5m  
On 30sec.

**2in1 Cover-it Panels new**

Kunststoff Matière plastique Kunststoff

○ neutral white = 4.000 K

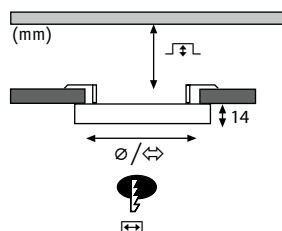
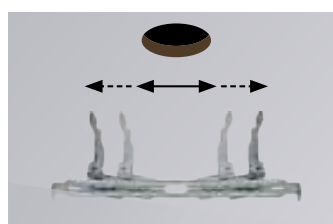

	<b>ø225 mm</b>		1.800 lm		incl. 1×16,5 W	└┴┴35 mm	└┴┴50-180 mm	EAN 4000870 953914	<b>953.91</b>
	<b>ø330 mm</b>		2.460 lm		incl. 1×22 W	└┴┴35 mm	└┴┴50-180 mm	EAN 4000870 953921	<b>953.92</b>
	<b>ø225 mm</b>		1.800 lm		incl. 1×16,5 W	└┴┴35 mm	└┴┴50-180 mm	EAN 4000870 953891	<b>953.89</b>
	<b>ø330 mm</b>		2.460 lm		incl. 1×22 W	└┴┴35 mm	└┴┴50-180 mm	EAN 4000870 953907	<b>953.90</b>



**Cover-it Panel**

Kunststoff Matière plastique Kunststoff

● warm white = 3.000 K

	<b>ø116 mm</b>		700 lm		incl. 1×6 W	└┴┴35 mm	└┴┴55-100 mm	EAN 4000870 037256	<b>3725</b>
	<b>ø165 mm</b>		1.400 lm		incl. 1×12 W	└┴┴35 mm	└┴┴55-125 mm	EAN 4000870 037263	<b>3726</b>

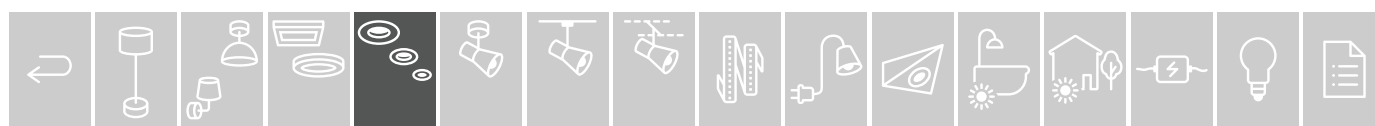

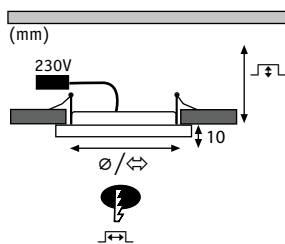

**Panel Areo dimmable**

☒ Kunststoff Matière plastique Kunststoff

- ▶ Spritzwassergeschützt (IP44)
- ▶ Geeignet für die Installation im Bad
- ▶ Protection contre les aspersion (IP44)
- ▶ Convient à l'installation dans des salles de bains
- ▶ Spatwaterdicht (IP44)
- ▶ Geschikt voor installatie in de badkamer

warm white = 3.000 K



**ø120 mm**

<b>W</b>	830 lm		incl. 1×8 W	↳ 35 mm	↳ 105 mm	EAN 4000870 929346	<b>929.34</b>
<b>NM</b>	830 lm		incl. 1×8 W	↳ 35 mm	↳ 105 mm	EAN 4000870 929360	<b>929.36</b>



**⇔120 ↗120 mm**

<b>W</b>	830 lm		incl. 1×8 W	↳ 35 mm	↳ 105x105 mm	EAN 4000870 929384	<b>929.38</b>
<b>NM</b>	830 lm		incl. 1×8 W	↳ 35 mm	↳ 105x105 mm	EAN 4000870 929407	<b>929.40</b>



**ø180 mm**

<b>W</b>	1.300 lm		incl. 1×12 W	↳ 35 mm	↳ 155 mm	EAN 4000870 929339	<b>929.33</b>
<b>NM</b>	1.300 lm		incl. 1×12 W	↳ 35 mm	↳ 155 mm	EAN 4000870 929353	<b>929.35</b>



**⇔180 ↗180 mm**

<b>W</b>	1.300 lm		incl. 1×12 W	↳ 35 mm	↳ 155x155 mm	EAN 4000870 929377	<b>929.37</b>
<b>NM</b>	1.300 lm		incl. 1×12 W	↳ 35 mm	↳ 155x155 mm	EAN 4000870 929391	<b>929.39</b>

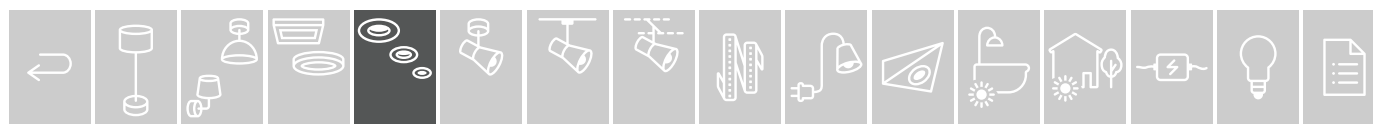



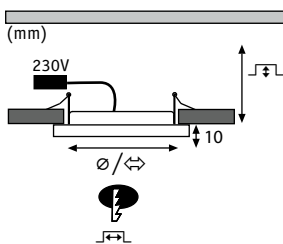

**Panel Areo IP23**      Kunststoff Matière plastique Kunststoff

**warm white = 3.000 K**

	<b>ø80 mm</b>						
<b>W</b>	615 lm		incl. 1×5 W	└─┬35 mm	└─┬75 mm	EAN 4000870 929452	<b>929.45</b>
<b>NM</b>	615 lm		incl. 1×5 W	└─┬35 mm	└─┬75 mm	EAN 4000870 929483	<b>929.48</b>
	<b>⇔80 ⇔80 mm</b>						
<b>W</b>	615 lm		incl. 1×5 W	└─┬35 mm	└─┬72x72 mm	EAN 4000870 929513	<b>929.51</b>
<b>NM</b>	615 lm		incl. 1×5 W	└─┬35 mm	└─┬72x72 mm	EAN 4000870 929544	<b>929.54</b>
	<b>ø120 mm</b>						
<b>W</b>	920 lm		incl. 1×8 W	└─┬35 mm	└─┬105 mm	EAN 4000870 929445	<b>929.44</b>
<b>NM</b>	920 lm		incl. 1×8 W	└─┬35 mm	└─┬105 mm	EAN 4000870 929476	<b>929.47</b>
	<b>⇔120 ⇔120 mm</b>						
<b>W</b>	920 lm		incl. 1×8 W	└─┬35 mm	└─┬105x105 mm	EAN 4000870 929506	<b>929.50</b>
<b>NM</b>	920 lm		incl. 1×8 W	└─┬35 mm	└─┬105x105 mm	EAN 4000870 929537	<b>929.53</b>
	<b>ø180 mm</b>						
<b>W</b>	1.350 lm		incl. 1×12 W	└─┬35 mm	└─┬155 mm	EAN 4000870 929438	<b>929.43</b>
<b>NM</b>	1.350 lm		incl. 1×12 W	└─┬35 mm	└─┬155 mm	EAN 4000870 929469	<b>929.46</b>
	<b>⇔180 ⇔180 mm</b>						
<b>W</b>	1.350 lm		incl. 1×12 W	└─┬35 mm	└─┬155x155 mm	EAN 4000870 929490	<b>929.49</b>
<b>NM</b>	1.350 lm		incl. 1×12 W	└─┬35 mm	└─┬155x155 mm	EAN 4000870 929520	<b>929.52</b>

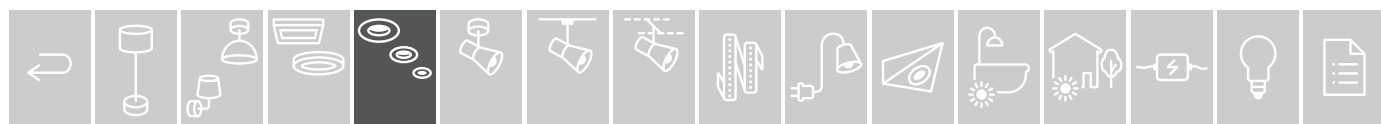

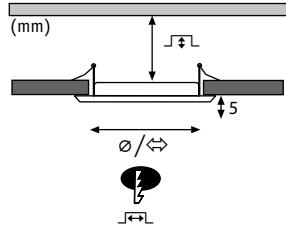

**Quality Line Panel IP44**

☒ Kunststoff Matière plastique Kunststof

● warm white = 2.700 K

**ø170 mm**



<b>W</b>	1.118 lm		incl. 1×12 W	↳ 35 mm	↳ 150 mm	EAN 4000870 920626	<b>920.62</b>
<b>CM</b>	1.118 lm		incl. 1×12 W	↳ 35 mm	↳ 150 mm	EAN 4000870 920749	<b>920.74</b>

**↔165 ↗165 mm**



<b>W</b>	1.119 lm		incl. 1×12 W	↳ 35 mm	↳ 155x155 mm	EAN 4000870 920688	<b>920.68</b>
<b>CM</b>	1.119 lm		incl. 1×12 W	↳ 35 mm	↳ 155x155 mm	EAN 4000870 920800	<b>920.80</b>



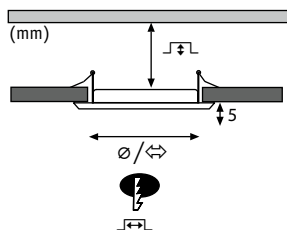

**Quality Line Panel IP44**

☒ Kunststoff Matière plastique Kunststoff

○ neutral white = 4.000 K

**ø115 mm**



<b>W</b>	671 lm		incl. 1×6 W	└─┘ 35 mm	└─┘ 100 mm	EAN 4000870 920589	<b>920.58</b>
<b>CM</b>	671 lm		incl. 1×6 W	└─┘ 35 mm	└─┘ 100 mm	EAN 4000870 920701	<b>920.70</b>

↔115 ↗115 mm



<b>W</b>	671 lm		incl. 1×6 W	└─┘ 35 mm	└─┘ 105x105 mm	EAN 4000870 920640	<b>920.64</b>
<b>CM</b>	671 lm		incl. 1×6 W	└─┘ 35 mm	└─┘ 105x105 mm	EAN 4000870 920763	<b>920.76</b>

**ø170 mm**



<b>W</b>	1.262 lm		incl. 1×12 W	└─┘ 35 mm	└─┘ 150 mm	EAN 4000870 920596	<b>920.59</b>
<b>CM</b>	1.262 lm		incl. 1×12 W	└─┘ 35 mm	└─┘ 150 mm	EAN 4000870 920718	<b>920.71</b>

↔165 ↗165 mm



<b>W</b>	1.263 lm		incl. 1×12 W	└─┘ 35 mm	└─┘ 155x155 mm	EAN 4000870 920657	<b>920.65</b>
<b>CM</b>	1.263 lm		incl. 1×12 W	└─┘ 35 mm	└─┘ 155x155 mm	EAN 4000870 920770	<b>920.77</b>

**ø220 mm**



<b>W</b>	2.011 lm		incl. 1×18 W	└─┘ 35 mm	└─┘ 200 mm	EAN 4000870 920602	<b>920.60</b>
<b>CM</b>	2.011 lm		incl. 1×18 W	└─┘ 35 mm	└─┘ 200 mm	EAN 4000870 920725	<b>920.72</b>

↔220 ↗220 mm



<b>W</b>	2.011 lm		incl. 1×16,5 W	└─┘ 35 mm	└─┘ 205x205 mm	EAN 4000870 920664	<b>920.66</b>
<b>CM</b>	2.011 lm		incl. 1×16,5 W	└─┘ 35 mm	└─┘ 205x205 mm	EAN 4000870 920787	<b>920.78</b>

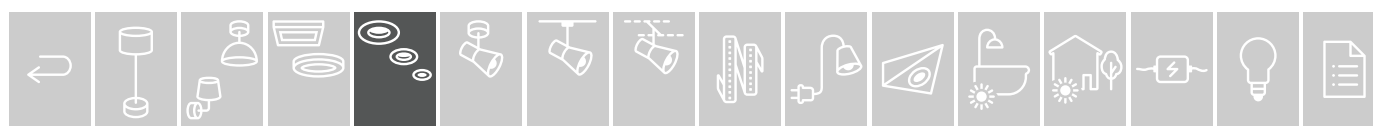

*Kombinieren Sie selbst Ihr persönliches Lichtsystem*  
*Composez vous-même votre système d'éclairage personnel*  
*Combineer uw persoonlijk lichtstelsel zelf*

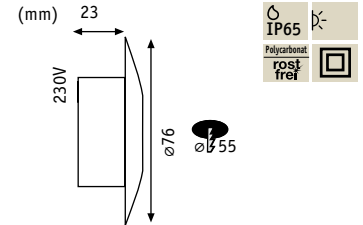
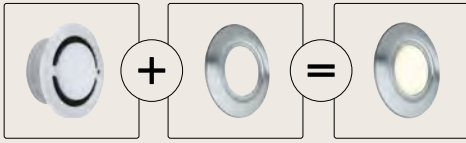

**IP65 Downlight Basic**

Polycarbonat Polycarbonate Polycarbonaat

- ▶ Werkzeuglose Montage der Edelstahldekore durch Klettverschluss
- ▶ Montage direkt in 60mm Einbaudosen möglich
- ▶ Fixation de l'habillage sans outils
- ▶ Possibilité de montage direct dans des embases encastrées de 60mm
- ▶ Met RVS-afdekking
- ▶ Rechtstreekse montage mogelijk in inbouwdozen van 60mm

Opal Opale Opaal



**incl. 1x1,4 W**  
 3.000 K  
 230 V  
 EAN 4000870 937402  
**937.40**

Opal Opale Opaal



**incl. 1x1,4 W**  
 4.000 K  
 230 V  
 EAN 4000870 937419  
**937.41**

Edelstahl Acier inoxydable Edelstaal

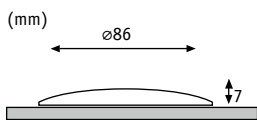
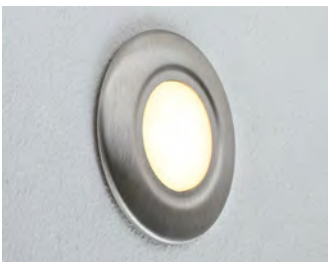

Edelstahl Acier inoxydable Edelstaal

**Cover round**

±7 ø86 mm  
 EAN 4000870 937426  
**937.42**

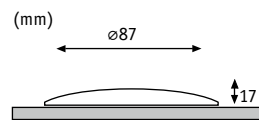

Edelstahl Acier inoxydable Edelstaal

**Cover Cap round**

±17 ø87 mm  
 EAN 4000870 937433  
**937.43**

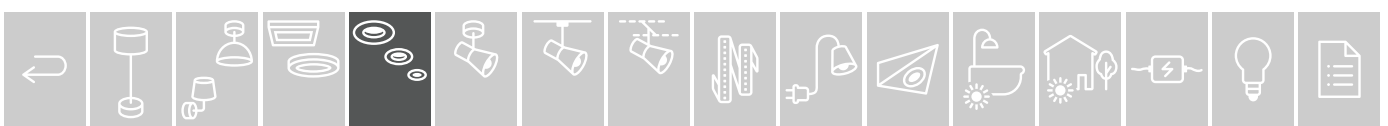

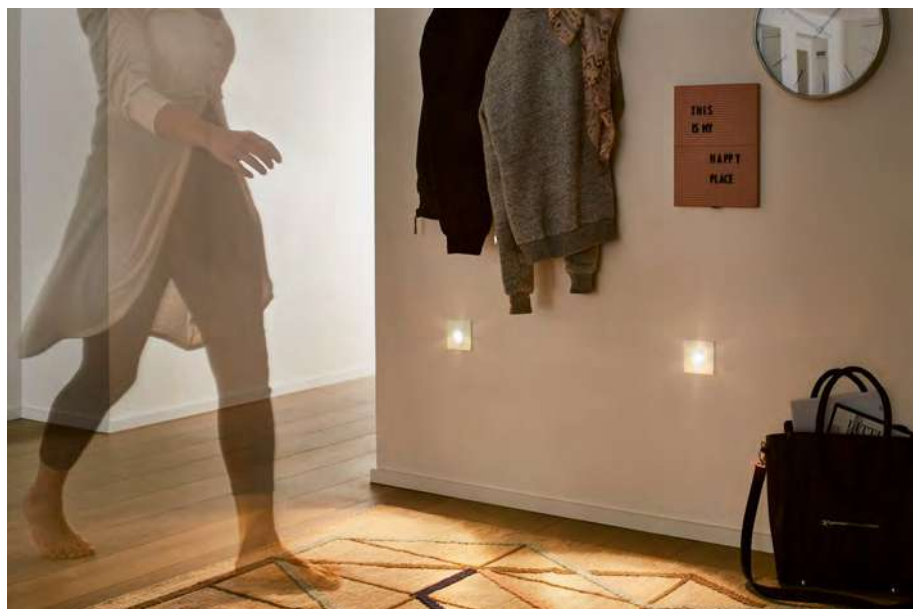

**Wall 230V** Kunststoff Matière plastique Kunststoff

- ▶ 230V Wandlicht
- ▶ Applique murale 230 V
- ▶ 230V wandlamp
- ▶ Eignet sich für gängige Hohlwanddosen
- ▶ Convient aux prises pour cloisons creuses standard
- ▶ Geschikt voor gangbare spouwmuurdozen

(mm)

35

78x78

⚡ 60

Weiß Blanc Wit

**incl. 1x1,1 W**  
 110 lm, 2.700 K  
 ✕ 67°  
 230 V  
 EAN 4000870 929223  
**929.22**

(mm)

35

78

⚡ 60

Weiß Blanc Wit

**incl. 1x1,1 W**  
 110 lm, 2.700 K  
 ✕ 67°  
 230 V  
 EAN 4000870 929247  
**929.24**

**Wall 230V** Kunststoff Matière plastique Kunststoff

- ▶ 230V Wandlicht
- ▶ Applique murale 230 V
- ▶ 230V wandlamp
- ▶ Bewegungsmelder
- ▶ Détecteur de mouvement
- ▶ Bewegungsmelder
- ▶ Eignet sich für gängige Hohlwanddosen
- ▶ Convient aux prises pour cloisons creuses standard
- ▶ Geschikt voor gangbare spouwmuurdozen

(mm)

35

78x78

⚡ 60

Time ON  
Sensor 4-5 min

Weiß Blanc Wit

**incl. 1x1,1 W**  
 100 lm, 2.700 K  
 ✕ 72°  
 230 V  
 EAN 4000870 929230  
**929.23**

(mm)

35

78

⚡ 60

Time ON  
Sensor 4-5 min

Weiß Blanc Wit

**incl. 1x2,7 W**  
 100 lm, 2.700 K  
 ✕ 72°  
 230 V  
 EAN 4000870 929254  
**929.25**

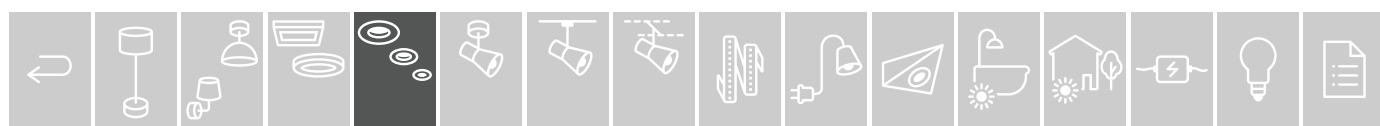

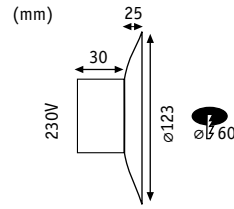

**Wall Neordic adjustable 230V**

Kunststoff Matière plastique Kunststoff

- ▶ Bewegliche Dekorplatte lenkt das Licht
- ▶ Montage direkt in Hohlwanddosen möglich
- ▶ Passend zu Neordic Wohnraumleuchten
- ▶ La plaque décorative mobile dirige la lumière
- ▶ Montage direct possible dans prises pour cloisons creuses
- ▶ Convient aux éclairages Neordic
- ▶ Beweegbare decoratieve plaat leidt het licht
- ▶ Montage direct in de spouwmuurdozen mogelijk
- ▶ Passend bij Neordic woonkamerlampen



Wei matt Blanc dpoli Wit mat

**incl. 1x2,5 W**

180 lm, 2.700 K

230 V

EAN 4000870 929261

**929.26**

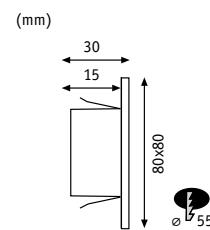
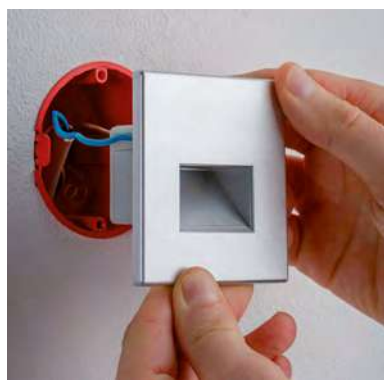

**Wall LED Edge**

Kunststoff Matière plastique Kunststoff

- ▶ Eignet sich fr gngige Hohlwanddosen
- ▶ 230V Wandlicht
- ▶ Convient aux prises pour cloisons creuses standard
- ▶ Applique murale 230 V
- ▶ Geschikt voor gangbare spouwmuurdozen
- ▶ 230V wandlamp



Chrom matt Chrome mat Chroom mat

**incl. 1x1,1 W**

116 lm, 2.700 K

∠ 100°

230 V

EAN 4000870 994955

**994.95**



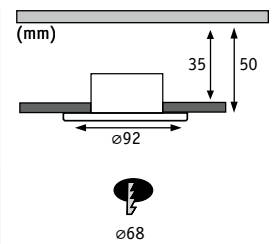

**Pendant Adapter**

☒ Metal/Kunststoff Métal/Matière plastique Metaal/Kunststof

- ▶ Max. 3 kg
- ▶ Für Kabel bis max. 6,5 mm Durchmesser

- ▶ 3kg maximum
- ▶ Pour câbles de section maximale 6,5 mm

- ▶ Max. 3 kg
- ▶ Voor kabels tot max. 6,5mm diameter



☞ Weiß matt Blanc dépoli Wit mat

EAN 4000870 924969  
**924.96**



☞ Alu gedreht Alu tourné Alu gedraaid

EAN 4000870 924976  
**924.97**



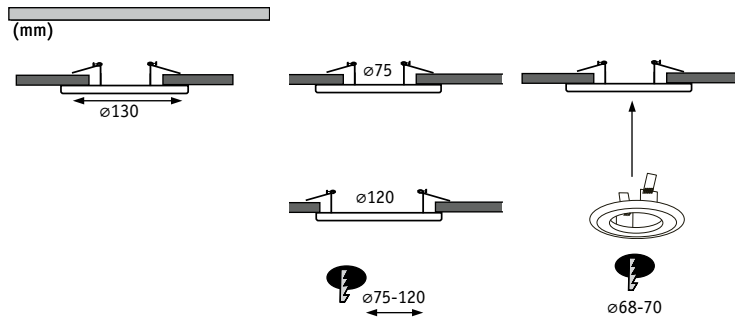

**Downlight adapter**

Metall Métal Metaal

- ▶ Adapterring zur Verringerung des Einbaudurchmessers
- ▶ Für starre und schwenkbare Paulmann-Einbauleuchten (Einbaudurchmesser 68-70 mm)
- ▶ Bague de réduction du diamètre d'encastrement
- ▶ Pour encastrés fixes et orientables Paulmann (diamètre d'encastrement 68-70 mm)
- ▶ Adapterring voor het verminderen van de inbouwdiameter
- ▶ Voor stijve en zwenkbare Paulmann-inbouwlampen (inbouwdiameter 68-70mm)

Wei matt Blanc dépoli Wit mat

Eisen gebrstet Acier brossé Staal geborsteld



**max. 50 W**  
EAN 4000870 924990  
**924.99**



**max. 50 W**  
EAN 4000870 924983  
**924.98**



**Einbautopf  
Couvrele encastré  
Inbouwpot**

Metall Métal Metaal

- ▶ Der Einbautopf ist die ideale Ergnzung fr die Installation schwenkbarer Einbauleuchten - einfach auf die Einbauleuchte aufgesteckt, schtzt dieser die Leuchte und z.B. Dmmmaterialien.
- ▶ Fassung inklusive
- ▶ Anschluss mit Hilfe einer Verbindungsbox
- ▶ La cloche d'encastrement est le complément idéal pour l'installation d'encastrés orientables - en s'emboitant tout simplement sur les encastrés, elles protègent le matériau isolant environnant.
- ▶ Raccordement avec l'aide d'un boîtier de jonction
- ▶ De inbouwbehuizing is de ideale aanvulling voor de installatie zwenkbare inbouwlampen - eenvoudig op de inbouwlamp opgestoken, beschermt deze de lamp en bijv. het isolatiemateriaal.
- ▶ Inclusief fitting
- ▶ Aansluiting met behulp van een verbindingsdoos



Schwarz Noir Zwart

**max. 35 W**  
230 V  
EAN 4000870 002360  
**236**

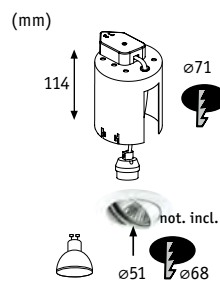





**12V, G4, GX5,3, GY6,35, GU5,3, GU4**

max. 50 W, G4 / GX5,3 / GY6,35

12 V

⇄170 ⇄15 ↗15 mm

EAN 4000870 002162

**216**

- 🌀 Weiß
- 🌀 Blanc
- 🌀 Wit

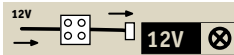

**12V, G4, GX5,3, GY6,35, GU5,3, GU4**

max. 75 W, G4 / GX5,3 / GY6,35

12 V

EAN 4000870 021897

**218.9**

- 🌀 Keramik natur
- 🌀 Céramique
- 🌀 Keramiek natuur

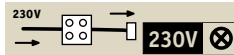

**230V GU10, GZ10**

GZ10

230 V

EAN 4000870 002179

**217**

- 🌀 Keramik natur
- 🌀 Céramique
- 🌀 Keramiek natuur

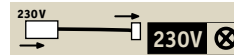

**230V GU10 Box**

max. 50 W, GU10

230 V

⇄23 ⇄70 ↗35 mm

EAN 4000870 938102

**938.10**

- 🌀 Schwarz 🧱 Kunststoff
- 🌀 Noir 🧱 Matière plastique
- 🌀 Zwart 🧱 Kunststof

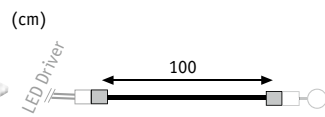
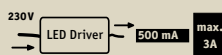
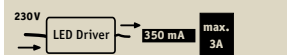

**Adapter JST 1x1m, 350, 500, 700, 1000, 1400mA (2x0,5mm<sup>2</sup>)**

⇄1 m

EAN 4000870 002339

**233**



**Sprenging (Kunststoff)  
Circlips (matière plastique)  
Veerring (Kunststof)**



⇄4 ø50 ⇄45 ↗45 mm

EAN 4000870 000274

**404001963**

**Sprenging (Metall)  
Circlips (Métal)  
Veerring (Metaal)**



ø35 mm  
EAN 4000870 000267  
**404000753**



ø51 mm  
EAN 4000870 000250  
**404000752**



3x  
⇄4 ø51 ⇄58 ↗50 mm  
EAN 4000870 937617  
**937.61**



ø51 mm  
EAN 4000870 000236  
**404000125**



3x  
⇄4 ø51 ⇄58 ↗52 mm  
EAN 4000870 937624  
**937.62**



# Spotlights



□ = 146

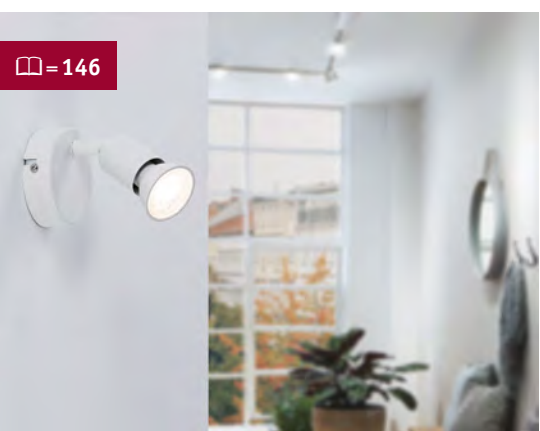

□ = 146





□ = 147



□ = 148





⚙ Weiß matt/Chrom  Metall  
 ⚙ Blanc dépoli/Chrome  Métal  
 ⚙ Wit mat/Chroom  Metaal

**Frame**

incl. 1×4,5 W  
 468 lm, 3.000 K  
 <math>\sphericalangle 110^\circ</math>  
 230 V  
 ⌀140 ⇄88 ↗131 mm  
 EAN 4000870 666388  
**666.38**

**Frame**

incl. 2×4,5 W  
 2×468 lm, 3.000 K  
 <math>\sphericalangle 110^\circ</math>  
 230 V  
 ⌀131 ⇄280 ↗100 mm  
 EAN 4000870 666395  
**666.39**

**Frame**

incl. 3×4,5 W  
 3×468 lm, 3.000 K  
 <math>\sphericalangle 110^\circ</math>  
 230 V  
 ⌀131 ⇄430 ↗100 mm  
 EAN 4000870 666401  
**666.40**

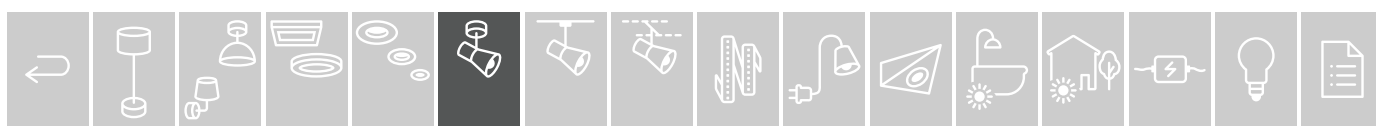



⌘ Nickel matt   Metall  
 ⌘ Nickel mat   Métal  
 ⌘ Nikkel mat   Metaal



**Carolina**  
 max. 10W, GU10  
 230V  
 ⌀110 ø80 mm  
 EAN 4000870 667439  
**667.43**



**Carolina**  
 max. 2×10W, GU10  
 230V  
 ⌀124 ⇄305 ↗80 mm  
 EAN 4000870 667446  
**667.44**



**Carolina**  
 max. 3×10W, GU10  
 230V  
 ⌀124 ⇄482 ↗80 mm  
 EAN 4000870 667453  
**667.45**



**Carolina**  
 max. 4×10W, GU10  
 230V  
 ⌀124 ⇄584 ↗80 mm  
 EAN 4000870 667460  
**667.46**



⌘ Weiß matt   Metall  
 ⌘ Blanc dépoli   Métal  
 ⌘ Wit mat   Metaal



Perfect match  
 □ = 424, 401



**Carolina**  
 max. 10W, GU10  
 230V  
 ⌀110 ø80 mm  
 EAN 4000870 667637  
**667.63 new**



**Carolina**  
 max. 2×10W, GU10  
 230V  
 ⌀124 ⇄305 ↗80 mm  
 EAN 4000870 667644  
**667.64 new**



**Carolina**  
 max. 3×10W, GU10  
 230V  
 ⌀124 ⇄428 ↗80 mm  
 EAN 4000870 667651  
**667.65 new**



**Carolina**  
 max. 4×10W, GU10  
 230V  
 ⌀124 ⇄584 ↗80 mm  
 EAN 4000870 667545  
**667.54 new**

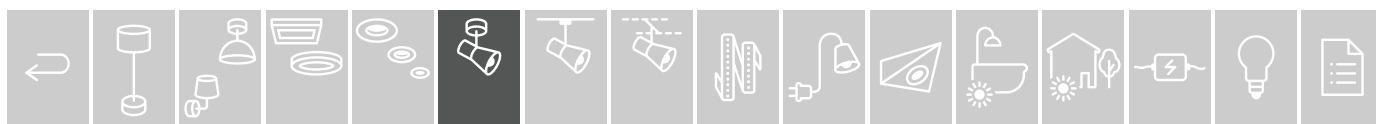



- ⌘ Schwarz matt 𠄎 Metall
- ⌘ Noir mat 𠄎 Métal
- ⌘ Zwart mat 𠄎 Metaal

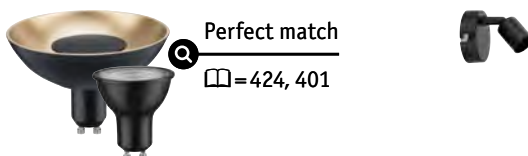

Perfect match

𠄎 = 424, 401



**Carolina**

max. 10W, GU10  
230V  
⌀110 ⌀80 mm  
EAN 4000870 667552  
**667.55 new**



**Carolina**

max. 2x10W, GU10  
230V  
⌀124 ⇄305 ⌀80 mm  
EAN 4000870 667569  
**667.56 new**



**Carolina**

max. 3x10W, GU10  
230V  
⌀124 ⇄428 ⌀80 mm  
EAN 4000870 667576  
**667.57 new**



**Carolina**

max. 4x10W, GU10  
230V  
⌀124 ⇄584 ⌀80 mm  
EAN 4000870 667583  
**667.58 new**

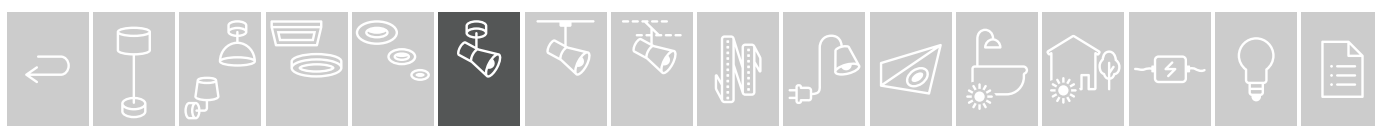



⚙ Schwarz Metall  
 ⚙ Noir Métal  
 ⚙ Zwart Metaal



Perfect match

= 409-411  
 427



**Davy**

max. 20 W, E27  
 230 V  
 ⚙140 ⚙112 ⚙147 mm  
 EAN 4000870 667590  
**667.59 new**



**Davy**

max. 2×20 W, E27  
 230 V  
 ⚙164 ⚙425 ⚙112 mm  
 EAN 4000870 667606  
**667.60 new**



**Davy**

max. 3×20 W, E27  
 230 V  
 ⚙164 ⚙625 ⚙112 mm  
 EAN 4000870 667613  
**667.61 new**



**Davy**

max. 4×20 W, E27  
 230 V  
 ⚙164 ⚙825 ⚙112 mm  
 EAN 4000870 667620  
**667.62 new**



⚙ Nickel satiniert Metall  
 ⚙ Nickel satiné Métal  
 ⚙ Nikkel gesatineerd Metaal



**Meli**

max. 2×10 W, GU10  
 230 V  
 ⚙160 ⚙260 ⚙55 mm  
 EAN 4000870 666876  
**666.87**



**Meli**

max. 3×10 W, GU10  
 230 V  
 ⚙160 ⚙400 ⚙55 mm  
 EAN 4000870 666883  
**666.88**



**Meli**

max. 4×10 W, GU10  
 230 V  
 ⚙160 ⚙600 ⚙55 mm  
 EAN 4000870 666890  
**666.89**

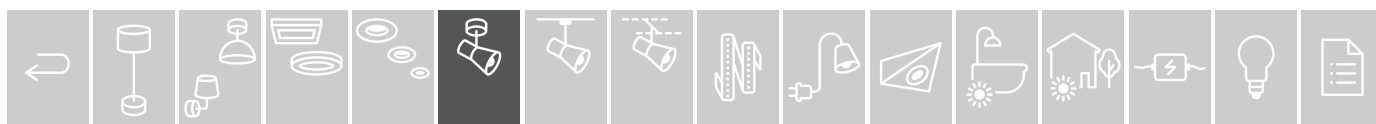



⌘ Nickel satiniert   Metall  
 ⌘ Nickel satiné   Métal  
 ⌘ Nikkel gesatineerd   Metaal

**Teja**

max. 10 W, GU10  
 230 V  
 ⌀100 ⇄52 ↗120 mm  
 EAN 4000870 666982  
**666.98**

**Teja**

max. 2×10 W, GU10  
 230 V  
 ⌀120 ⇄308 ↗52 mm  
 EAN 4000870 666999  
**666.99**

**Teja**

max. 3×10 W, GU10  
 230 V  
 ⌀120 ⇄500 ↗52 mm  
 EAN 4000870 667002  
**667.00**

**Teja**

max. 4×10 W, GU10  
 230 V  
 ⌀120 ⇄250 ↗250 mm  
 EAN 4000870 667019  
**667.01**



⌘ Weiß   Metall  
 ⌘ Blanc   Métal  
 ⌘ Wit   Metaal

**Teja**

max. 10 W, GU10  
 230 V  
 ⌀100 ⇄52 ↗120 mm  
 EAN 4000870 667026  
**667.02**

**Teja**

max. 2×10 W, GU10  
 230 V  
 ⌀120 ⇄308 ↗52 mm  
 EAN 4000870 667033  
**667.03**

**Teja**

max. 3×10 W, GU10  
 230 V  
 ⌀120 ⇄500 ↗52 mm  
 EAN 4000870 667040  
**667.04**

**Teja**

max. 4×10 W, GU10  
 230 V  
 ⌀120 ⇄250 ↗250 mm  
 EAN 4000870 667057  
**667.05**

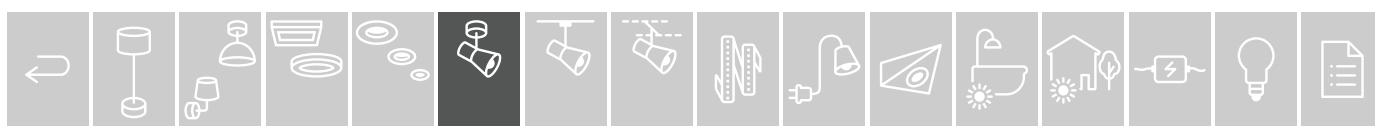

# Rail Systems

- 152 DecoSystems
- 154 Spots
- 166 Ceiling lamps |
- 168 Pendulum lamps
- 172 2Easy
- 174 Accessories |



## URail

### Deine Ideen, dein Licht, dein System

Mit einer Lichtschiene Spots und Pendel in der ganzen Wohnung verteilen. URail bietet unendliche Möglichkeiten ohne komplizierte Montage. Alle Komponenten sind untereinander kombinierbar und schnell installiert.

- ▶ Zur direkten Deckenmontage, abgehängt oder Wandmontage
- ▶ Hohe Flexibilität durch vielfältiges Zubehör
- ▶ Einfach zu Schalten und Dimmen, auch per Fernbedienung, Sprache oder App

### Vos idées, votre lumière, votre système

Répartir les spots et suspensions dans toute la maison sur un seul rail lumineux. URail offre des possibilités infinies sans montage compliqué. Tous les éléments se combinent entre eux et s'installent rapidement.

- ▶ Pour un montage au plafond direct, en suspension ou en pose murale
- ▶ Grande flexibilité grâce à de nombreux accessoires
- ▶ Commutation et variation d'intensité facile, y compris par télécommande, commande vocale ou application

### Jouw ideeën, jouw licht, jouw systeem

Met een lichtrail spots en pendels over de hele woning verdelen. U-rail biedt onbegrensde mogelijkheden zonder ingewikkelde montage. Alle componenten kunnen met elkaar worden gecombineerd en zijn snel te installeren.

- ▶ Voor rechtstreekse plafondmontage, hangend of wandmontage
- ▶ Hoge flexibiliteit door diverse accessoires
- ▶ Eenvoudig te schakelen en te dimmen, ook per afstandsbediening, spraak of app

DE In drei einfachen Schritten zum System

FR Accès au système en trois étapes simples

NL Het systeem in drie eenvoudige stappen



DE 1. Schienen wählen

2. Einspeisungen und Verbinder wählen

3. Spot oder Pendel wählen

Fertig!

FR 1. Sélectionner les rails

2. Choisir les alimentations et les connecteurs

3. Choisir les spots ou suspensions

Terminé !

NL 1. Rails kiezen

2. Voedingen en verbindingen kiezen

3. Spot of pendel kiezen

Klaar!

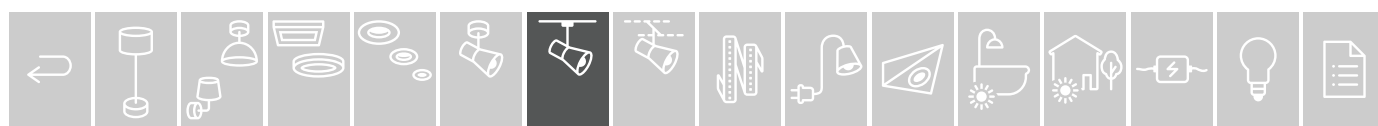





DE in stilvollem Chrom Matt  
FR en chrome mat stylé  
NL in stijlvol Chromo mat



DE in zeitlosem Weiß  
FR en blanc intemporel  
NL in tijdloos Wit

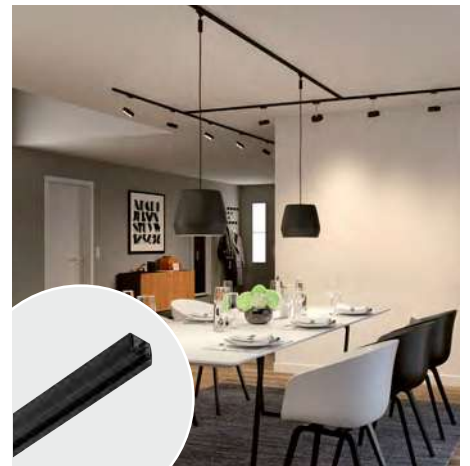

DE in elegantem Schwarz Matt  
FR en noir mat élégant  
NL in elegant Zwart mat

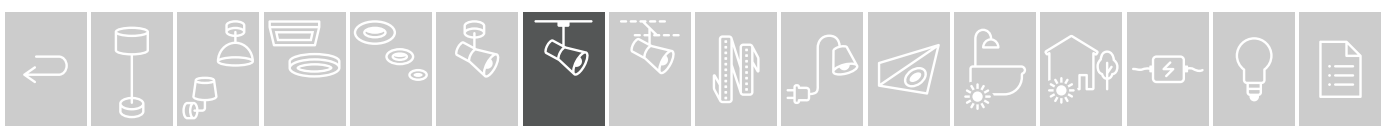

*Kombinieren Sie selbst Ihr persönliches Lichtsystem*  
*Composez vous-même votre système d'éclairage personnel*  
*Combineer uw persoonlijk lichtstelsel zelf*

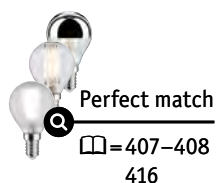
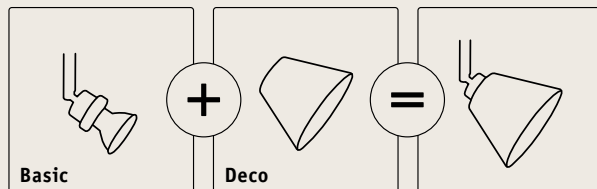

**Basic-Pendant**  
 max. 20 W, E14  
 230 V  
 ⚡ 135 cm ø44 mm  
 EAN 4000870 969694  
**969.69**  
 ⚡ Chrom matt □ Metall/  
 Kunststoff  
 ⚡ Chrome mat □ Métal/  
 Matière plastique  
 ⚡ Chroom mat □ Metaal/  
 Kunststof



**Basic-Spot**  
 max. 20 W, E14  
 230 V  
 ⚡ 163 ø44 mm  
 EAN 4000870 969687  
**969.68**  
 ⚡ Chrom matt □ Metall/  
 Kunststoff  
 ⚡ Chrome mat □ Métal/  
 Matière plastique  
 ⚡ Chroom mat □ Metaal/  
 Kunststof



**Basic-Pendant**  
 max. 20 W, E14  
 230 V  
 ⚡ 135 cm ø44 mm  
 EAN 4000870 969717  
**969.71**  
 ⚡ Weiß □ Metall/Kunststoff  
 ⚡ Blanc □ Métal/  
 Matière plastique  
 ⚡ Wit □ Metaal/Kunststof



**Basic-Spot**  
 max. 20 W, E14  
 230 V  
 ⚡ 163 ø44 mm  
 EAN 4000870 969700  
**969.70**  
 ⚡ Weiß □ Metall/Kunststoff  
 ⚡ Blanc □ Métal/  
 Matière plastique  
 ⚡ Wit □ Metaal/Kunststof



**Basic Pendant**  
 max. 20 W, E14  
 230 V  
 ⚡ 135 cm ø44 mm  
 EAN 4000870 969120  
**969.12**  
 ⚡ Schwarz matt □ Metall/  
 Kunststoff  
 ⚡ Noir mat □ Métal/  
 Matière plastique  
 ⚡ Zwart mat □ Metaal/Kunststof



**Basic Spot**  
 max. 20 W, E14  
 230 V  
 ⚡ 163 ø44 mm  
 EAN 4000870 969137  
**969.13**  
 ⚡ Schwarz matt □ Metall/  
 Kunststoff  
 ⚡ Noir mat □ Métal/  
 Matière plastique  
 ⚡ Zwart mat □ Metaal/Kunststof

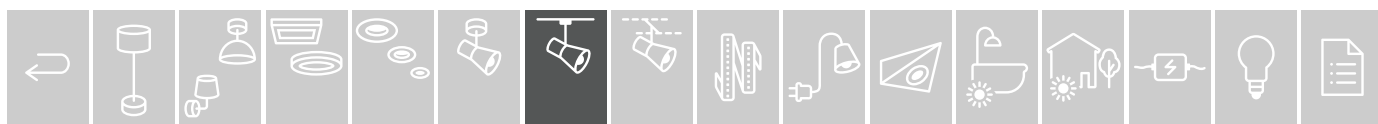



**Wolbi**  
 max. 50 W  
 ⚙️80 ø90 mm  
 EAN 4000870 600115  
**600.11**  
 ⚙️ Dichroic 🗄️ Glas  
 ⚙️ Dichroïque 🗄️ Verre  
 ⚙️ Dichroïsch 🗄️ Glas

**Vico**  
 max. 50 W  
 ⚙️95 ø80 mm  
 EAN 4000870 953570  
**953.57**  
 ⚙️ Klar 🗄️ Glas  
 ⚙️ Clair 🗄️ Verre  
 ⚙️ Helder 🗄️ Glas

**Twice**  
 max. 50 W  
 ⚙️70 ø100 mm  
 EAN 4000870 701744  
**701.74**  
 ⚙️ Klar/Opak 🗄️ Glas  
 ⚙️ Clair/Opaque 🗄️ Verre  
 ⚙️ Helder/Opaak 🗄️ Glas

**Vento**  
 max. 50 W  
 ⚙️95 ø80 mm  
 EAN 4000870 953594  
**953.59**  
 ⚙️ Rauchglas 🗄️ Glas  
 ⚙️ Verre fumé 🗄️ Verre  
 ⚙️ Rookglas 🗄️ Glas

**Vento**  
 max. 50 W  
 ⚙️95 ø80 mm  
 EAN 4000870 953587  
**953.58**  
 ⚙️ Satin 🗄️ Glas  
 ⚙️ Satiné 🗄️ Verre  
 ⚙️ Satijn 🗄️ Glas



**Wolbi**  
 max. 50 W  
 ⚙️70 ø90 mm  
 EAN 4000870 600559  
**600.55**  
 ⚙️ Opal 🗄️ Glas  
 ⚙️ Opale 🗄️ Verre  
 ⚙️ Opaal 🗄️ Glas

**Quad**  
 max. 50 W  
 ⚙️80 ø75 mm  
 EAN 4000870 600153  
**600.15**  
 ⚙️ Weiß 🗄️ Glas  
 ⚙️ Blanc 🗄️ Verre  
 ⚙️ Wit 🗄️ Glas

**Kegi**  
 max. 50 W  
 ⚙️80 ø110 mm  
 EAN 4000870 600122  
**600.12**  
 ⚙️ Weiß 🗄️ Glas  
 ⚙️ Blanc 🗄️ Verre  
 ⚙️ Wit 🗄️ Glas

**Wolbi**  
 max. 50 W  
 ⚙️80 ø90 mm  
 EAN 4000870 600078  
**600.07**  
 ⚙️ Weiß 🗄️ Glas  
 ⚙️ Blanc 🗄️ Verre  
 ⚙️ Wit 🗄️ Glas

**Zyli**  
 max. 50 W  
 ⚙️80 ø70 mm  
 EAN 4000870 600047  
**600.04**  
 ⚙️ Weiß 🗄️ Glas  
 ⚙️ Blanc 🗄️ Verre  
 ⚙️ Wit 🗄️ Glas



**DecoSystems Diffusor**  
 max. 20 W  
 ⚙️1,5 ø255 mm  
 EAN 4000870 954935  
**954.93** 📦  
 ⚙️ Satin 🗄️ Kunststoff  
 ⚙️ Satiné  
 🗄️ Matière plastique  
 ⚙️ Satijn 🗄️ Kunststof



**Tessa**  
 max. 50 W  
 ⚙️152 ø255 mm  
 EAN 4000870 603499  
**603.49**  
 ⚙️ Dunkelbraun 🗄️ Stoff  
 ⚙️ Marron foncé 🗄️ Tissus  
 ⚙️ Donkerbruin 🗄️ Textiel

**Tessa**  
 max. 50 W  
 ⚙️152 ø255 mm  
 EAN 4000870 603505  
**603.50**  
 ⚙️ Caramel 🗄️ Stoff  
 ⚙️ Caramel 🗄️ Tissus  
 ⚙️ Caramel 🗄️ Textiel

**Tessa**  
 max. 50 W  
 ⚙️152 ø255 mm  
 EAN 4000870 603512  
**603.51**  
 ⚙️ Creme 🗄️ Stoff  
 ⚙️ Crème 🗄️ Tissus  
 ⚙️ Crème 🗄️ Textiel

**Tessa**  
 max. 50 W  
 ⚙️152 ø255 mm  
 EAN 4000870 603529  
**603.52**  
 ⚙️ Hellgrau 🗄️ Stoff  
 ⚙️ Gris clair 🗄️ Tissus  
 ⚙️ Lichtgrijs 🗄️ Textiel

**Tessa**  
 max. 50 W  
 ⚙️152 ø255 mm  
 EAN 4000870 603260  
**603.26**  
 ⚙️ Weiß 🗄️ Stoff  
 ⚙️ Blanc 🗄️ Tissus  
 ⚙️ Wit 🗄️ Textiel

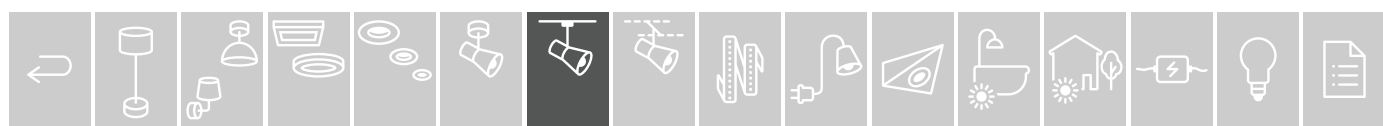

*Spots mit festverbauter LED dimmbar*  
*Spots avec LED intégrée fixe – gradables*  
*Spots met vast geïntegreerde LED dimbaar*

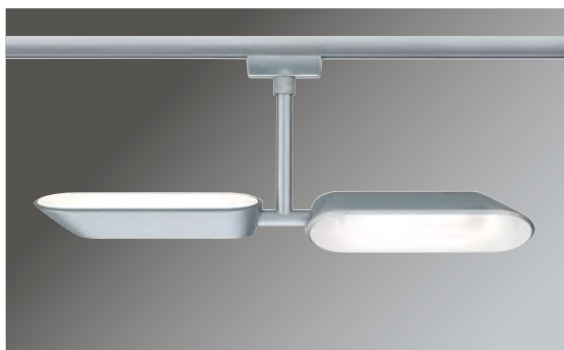

**Spot Dipper**

incl. 2×8,1 W  
 2×670 lm, 2.700 K  
 ∠ 83°

230 V

∅170 ↔375 ∇26 mm

EAN 4000870 954690

**954.69**

☞ Chrom matt/Weiß ☒ Metall/Kunststoff

☞ Chrome mat/Blanc ☒ Métal/

Matière plastique

☞ Chroom mat/Wit ☒ Metaal/Kunststof



**Spot Sabik**

incl. 1×8,7 / 1×4,3 W  
 887 + 461 lm, 2.700 K

230 V

∅225 ∅117 ∇62 mm

EAN 4000870 949795

**949.79**

☞ Weiß matt/Chrom matt

☒ Metall/Kunststoff

☞ Blanc dépoli/Chrome mat

☒ Métal/Matière plastique

☞ Wit mat/Chroom mat

☒ Metaal/Kunststof

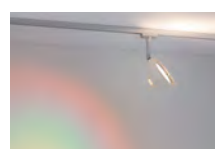
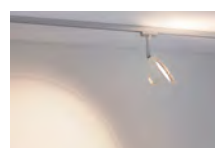

incl. dichroic foil





**Spot Arena**

incl. 1x9,9W  
1.180 lm, 2.700 K  
∠ 84°  
230 V  
∅191 ⇄123 ∅78 mm  
EAN 4000870 954461



**954.46**

- ⌘ Chrom matt/Chrom   Metall
- ⌘ Chrome mat/Chrome   Métal
- ⌘ Chroom mat/Chroom   Metaal

**Spot Arena**

incl. 1x9,9W  
1.180 lm, 2.700 K  
∠ 84°  
230 V  
∅191 ⇄123 ∅78 mm  
EAN 4000870 954478



**954.47**

- ⌘ Weiß/Chrom   Metall
- ⌘ Blanc/Chrome   Métal
- ⌘ Wit/Chroom   Metaal

**Spot Arena**

incl. 1x9,9W  
1.050 lm, 2.700 K  
∠ 82°  
230 V  
∅191 ⇄123 ∅78 mm  
EAN 4000870 969243



**969.24**

- ⌘ Schwarz matt/Chrom   Metall
- ⌘ Noir mat/Chrome   Métal
- ⌘ Zwart mat/Chroom   Metaal

**Spot Arena**

incl. 1x9,9W  
1.100 lm, 4.000 K  
∠ 82°  
230 V  
∅191 ⇄123 ∅78 mm  
EAN 4000870 969427



**969.42**

- ⌘ Schwarz matt/Chrom   Metall
- ⌘ Noir mat/Chrome   Métal
- ⌘ Zwart mat/Chroom   Metaal



**Spot Aldan**

incl. 1x8W  
720 lm, 2.700 K  
∠ 65°  
230 V  
∅170 ∅98 mm  
EAN 4000870 955192



**955.19**

- ⌘ Chrom matt/Schwarz   Metall/Kunststoff
- ⌘ Chrome mat/Noir   Metall/Kunststoff
- ⌘ Chroom mat/Zwart   Metall/Kunststoff

**Spot Aldan**

incl. 1x8W  
720 lm, 2.700 K  
∠ 65°  
230 V  
∅170 ∅98 mm  
EAN 4000870 953952



**953.95 new**

- ⌘ Weiß/Schwarz   Metall
- ⌘ Blanc/Noir   Métal
- ⌘ Wit/Zwart   Metaal

**Spot Aldan**

incl. 1x8W  
720 lm, 2.700 K  
∠ 65°  
230 V  
∅170 ∅98 mm  
EAN 4000870 969274



**969.27**

- ⌘ Schwarz matt/Chrom   Metall/Kunststoff
- ⌘ Noir mat/Chrome   Métal/Matière plastique
- ⌘ Zwart mat/Chroom   Metaal/Kunststof

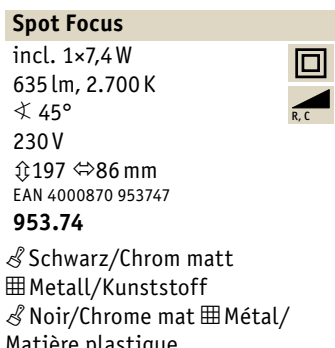
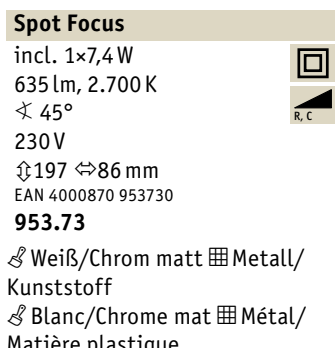

**Spot Focus**

incl. 1x7,4 W  
635 lm, 2.700 K  
∠ 45°  
230 V  
∅197 ⇄86 mm  
EAN 4000870 953730



**953.73**

- ⌘ Weiß/Chrom matt   Metall/Kunststoff
- ⌘ Blanc/Chrome mat   Métal/Matière plastique
- ⌘ Wit/Chroom mat   Metaal/Kunststof

**Spot Focus**

incl. 1x7,4 W  
635 lm, 2.700 K  
∠ 45°  
230 V  
∅197 ⇄86 mm  
EAN 4000870 953747



**953.74**

- ⌘ Schwarz/Chrom matt   Metall/Kunststoff
- ⌘ Noir/Chrome mat   Métal/Matière plastique
- ⌘ Zwart/Chroom mat   Metaal/Kunststof

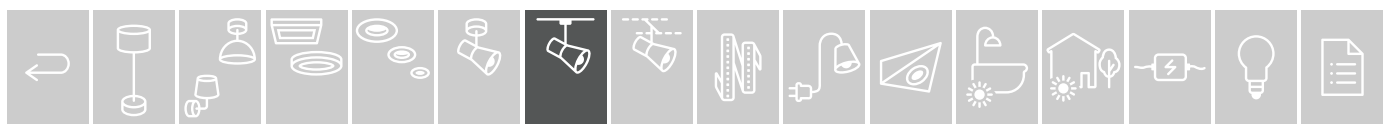



**Spot Cube**

incl. 1x8 W  
770 lm, 2.700 K  
∠ 65°



230 V  
⌀165 ⇄77 ⌀47 mm  
EAN 4000870 955109

**955.10**

⌘ Chrom matt/Chrom ⌘ Metall/  
Kunststoff  
⌘ Chrome mat/Chrome ⌘ Métal/  
Matière plastique  
⌘ Chroom mat/Chroom  
⌘ Metaal/Kunststof

**Spot Cube**

incl. 1x8 W  
770 lm, 2.700 K  
∠ 65°



230 V  
⌀165 ⇄77 ⌀47 mm  
EAN 4000870 955116

**955.11**

⌘ Weiß/Chrom ⌘ Metall/  
Kunststoff  
⌘ Blanc/Chrome ⌘ Métal/  
Matière plastique  
⌘ Wit/Chroom ⌘ Metaal/  
Kunststof

**Spot Cube**

incl. 1x8 W  
770 lm, 2.700 K  
∠ 65°



230 V  
⌀165 ⇄77 ⌀47 mm  
EAN 4000870 969236

**969.23**

⌘ Schwarz matt/Chrom  
⌘ Metall/Kunststoff  
⌘ Noir mat/Chrome ⌘ Métal/  
Matière plastique  
⌘ Zwart mat/Chroom ⌘ Metaal/  
Kunststof

**Spot Cube**

incl. 1x8 W  
700 lm, 4.000 K  
∠ 65°



230 V  
⌀165 ⇄77 ⌀47 mm  
EAN 4000870 969410

**969.41**

⌘ Schwarz matt/Chrom  
⌘ Metall/Kunststoff  
⌘ Noir mat/Chrome ⌘ Métal/  
Matière plastique  
⌘ Zwart mat/Chroom ⌘ Metaal/  
Kunststof

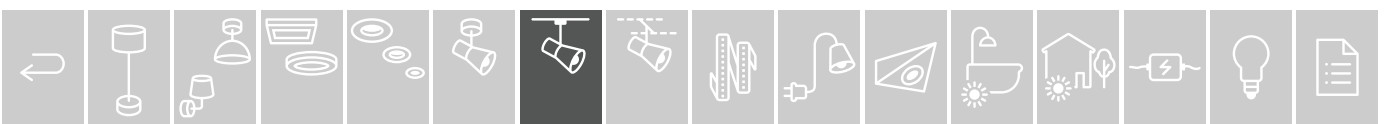



**Spot Sphere**

incl. 1x7 W  
635 lm, 2.700 K  
∠ 72°  
230 V  
∅183 ⇄119,8 ∅32 mm  
EAN 4000870 969366

**969.36**

- ☞ Chrom matt/Chrom
- ☒ Kunststoff
- ☞ Chrome mat/Chrome
- ☒ Matière plastique
- ☞ Chroom mat/Chroom
- ☒ Kunststof



**Spot Sphere**

incl. 1x7 W  
635 lm, 2.700 K  
∠ 72°  
230 V  
∅183 ⇄119,8 ∅32 mm  
EAN 4000870 969373

**969.37**

- ☞ Weiß/Chrom ☒ Kunststoff
- ☞ Blanc/Chrome
- ☒ Matière plastique
- ☞ Wit/Chroom ☒ Kunststof



**Spot Sphere**

incl. 1x7 W  
635 lm, 2.700 K  
∠ 72°  
230 V  
∅183 ⇄119,8 ∅32 mm  
EAN 4000870 969380

**969.38**

- ☞ Schwarz matt/Chrom
- ☒ Kunststoff
- ☞ Noir mat/Chrome
- ☒ Matière plastique
- ☞ Zwart mat/Chroom
- ☒ Kunststof



**Spot Discus**

incl. 1x5,3 W  
440 lm, 2.700 K  
∠ 45°  
230 V  
∅215 ⇄29 ∅95 mm  
EAN 4000870 968918

**968.91**

- ☞ Chrom matt/Chrom ☒ Metall/
- Kunststoff
- ☞ Chrome mat/Chrome ☒ Métal/
- Matière plastique
- ☞ Chroom mat/Chroom
- ☒ Metaal/Kunststof



**Spot Discus**

incl. 1x5,3 W  
440 lm, 2.700 K  
∠ 45°  
230 V  
∅215 ⇄29 ∅95 mm  
EAN 4000870 969229

**969.22**

- ☞ Schwarz matt/Chrom
- ☒ Metall/Kunststoff
- ☞ Noir mat/Chrome ☒ Métal/
- Matière plastique
- ☞ Zwart mat/Chroom ☒ Metaal/
- Kunststof

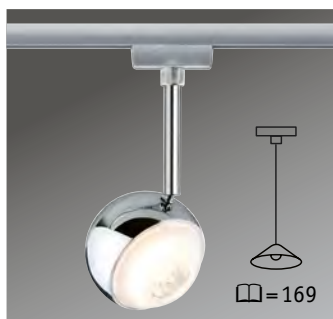

**Spot Capsule II**

incl. 1x6,3 W  
420 lm, 2.700 K  
∠ 30°  
230 V  
∅210 ⇄80 ∅80 mm  
EAN 4000870 954553

**954.55**

- ☞ Chrom matt/Chrom ☒ Metall/
- Kunststoff
- ☞ Chrome mat/Chrome ☒ Métal/
- Matière plastique
- ☞ Chroom mat/Chroom
- ☒ Metaal/Kunststof

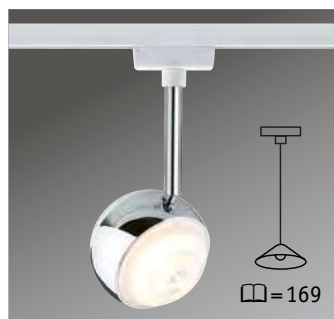

**Spot Capsule II**

incl. 1x6,3 W  
420 lm, 2.700 K  
∠ 30°  
230 V  
∅210 ⇄80 ∅80 mm  
EAN 4000870 954560

**954.56**

- ☞ Weiß/Chrom ☒ Metall/
- Kunststoff
- ☞ Blanc/Chrome ☒ Métal/
- Matière plastique
- ☞ Wit/Chroom ☒ Metaal/
- Kunststof



**Spot Double Pellet**

incl. 2x5,4 W  
2x370 lm, 2.700 K  
∠ 40°  
230 V  
∅180 ⇄190 ∅40 mm  
EAN 4000870 954713

**954.71**

- ☞ Chrom matt/Weiß ☒ Metall/
- Kunststoff
- ☞ Chrome mat/Blanc ☒ Métal/
- Matière plastique
- ☞ Chroom mat/Wit ☒ Metaal/
- Kunststof



**Spot Pellet**

incl. 1x5,4 W  
370 lm, 2.700 K  
∠ 40°  
230 V  
∅180 ⇄80 ∅40 mm  
EAN 4000870 954737

**954.73**

- ☞ Chrom matt/Weiß ☒ Metall/
- Kunststoff ☞ Chrome mat/Blanc
- ☒ Métal/Matière plastique
- ☞ Chroom mat/Wit ☒ Metaal/
- Kunststof



**Spot Pellet**

incl. 1x5,4 W  
370 lm, 2.700 K  
∠ 40°  
230 V  
∅180 ⇄80 ∅40 mm  
EAN 4000870 954744

**954.74**

- ☞ Weiß/Chrom matt ☒ Metall/
- Kunststoff ☞ Blanc/Chrome mat
- ☒ Métal/Matière plastique
- ☞ Wit/Chroom mat ☒ Metaal/
- Kunststof

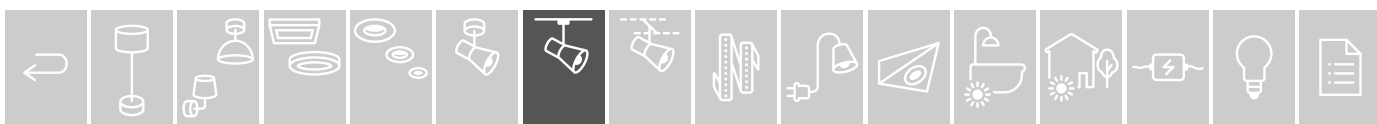



 warm white  
2700 K



 neutral white  
4000 K



**Spot Circle**

incl. 1x5 W  
375 lm, 2.700 K  
∠ 90°  
230 V  
∅147 ∅98 ∅50 mm  
EAN 4000870 969151  
**969.15**



☞ Schwarz matt/Chrom ☒ Metall/  
Kunststoff  
☞ Noir mat/Chrome ☒ Métal/  
Matière plastique  
☞ Zwart mat/Chroom ☒ Metaal/  
Kunststof

**Spot Circle**

incl. 1x5 W  
425 lm, 4.000 K  
∠ 90°  
230 V  
∅147 ∅98 ∅50 mm  
EAN 4000870 969397  
**969.39**



☞ Schwarz matt/Chrom ☒ Metall/  
Kunststoff  
☞ Noir mat/Chrome ☒ Métal/  
Matière plastique  
☞ Zwart mat/Chroom ☒ Metaal/  
Kunststof

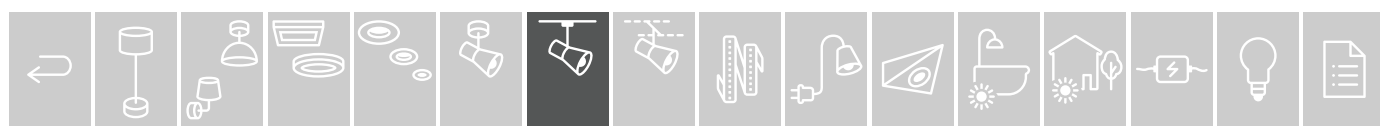



*Spots mit festverbauter LED nicht dimmbar*  
*Spots avec LED intégrée fixe – non gradables*  
*Spots met vast geïntegreerde LED niet dimbaar*



**Spot Pedal**

incl. 1x5 W  
 395 lm, 2.700 K  
 <math>\sphericalangle 100^\circ</math>  
 230 V  
 ⌀175 ⇄50 ⌀48 mm  
 EAN 4000870 952696  
**952.69**



⌘ Chrom matt ▣ Metall/  
 Kunststoff  
 ⌘ Chrome mat ▣ Métal/  
 Matière plastique  
 ⌘ Chroom mat ▣ Metaal/  
 Kunststof

**Spot Pedal**

incl. 1x5 W  
 395 lm, 2.700 K  
 <math>\sphericalangle 100^\circ</math>  
 230 V  
 ⌀175 ⇄50 ⌀48 mm  
 EAN 4000870 952702  
**952.70**



⌘ Weiß ▣ Metall/Kunststoff  
 ⌘ Blanc ▣ Métal/  
 Matière plastique  
 ⌘ Wit ▣ Metaal/Kunststof

**Spot Circle**

incl. 1x5,3 W  
 408 lm, 2.700 K  
 <math>\sphericalangle 90^\circ</math>  
 230 V  
 ⌀147 ⇄98 ⌀50 mm  
 EAN 4000870 952719  
**952.71**



⌘ Chrom matt ▣ Metall/  
 Kunststoff  
 ⌘ Chrome mat ▣ Métal/  
 Matière plastique  
 ⌘ Chroom mat ▣ Metaal/  
 Kunststof

**Spot Circle**

incl. 1x5,3 W  
 408 lm, 2.700 K  
 <math>\sphericalangle 90^\circ</math>  
 230 V  
 ⌀147 ⇄98 ⌀50 mm  
 EAN 4000870 952726  
**952.72**



⌘ Weiß ▣ Metall/Kunststoff  
 ⌘ Blanc ▣ Métal/  
 Matière plastique  
 ⌘ Wit ▣ Metaal/Kunststof

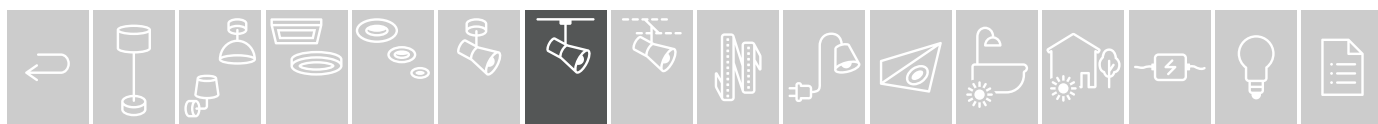



**Spot Tubo**  
 incl. 1x4,5 W  
 480 lm, 3.000 K  
 230 V  
 ⌀196 ⇄42 ⤴105 mm  
 EAN 4000870 955062  
**955.06**  
 ⌘ Chrom matt ▣ Metall/  
 Kunststoff  
 ⌘ Chrome mat ▣ Métal/  
 Matière plastique  
 ⌘ Chroom mat ▣ Metaal/  
 Kunststof



**Spot Tubo**  
 incl. 1x4,5 W  
 480 lm, 3.000 K  
 230 V  
 ⌀196 ⇄42 ⤴105 mm  
 EAN 4000870 955079  
**955.07**  
 ⌘ Weiß ▣ Metall/Kunststoff  
 ⌘ Blanc ▣ Métal/  
 Matière plastique  
 ⌘ Wit ▣ Metaal/Kunststof



**Spot Tubo**  
 incl. 1x4,5 W  
 480 lm, 3.000 K  
 230 V  
 ⌀186 ⇄42 ⤴105 mm  
 EAN 4000870 969175  
**969.17**  
 ⌘ Schwarz matt ▣ Metall/  
 Kunststoff  
 ⌘ Noir mat ▣ Métal/  
 Matière plastique  
 ⌘ Zwart mat ▣ Metaal/Kunststof



**Spot Tubo**  
 incl. 1x4,5 W  
 540 lm, 4.000 K  
 230 V  
 ⌀186 ⇄42 ⤴105 mm  
 EAN 4000870 969403  
**969.40**  
 ⌘ Schwarz matt/Chrom  
 ▣ Metall/Kunststoff  
 ⌘ Noir mat/Chrome ▣ Métal/  
 Matière plastique  
 ⌘ Zwart mat/Chroom ▣ Metaal/  
 Kunststof



**Spot Shine**  
 incl. 1x4,9 W  
 368 lm, 2.700 K  
 ∠ 75°  
 230 V  
 ⌀180 ⇄59 ⤴90 mm  
 EAN 4000870 952733  
**952.73**  
 ⌘ Chrom matt ▣ Metall/  
 Kunststoff  
 ⌘ Chrome mat ▣ Métal/  
 Matière plastique  
 ⌘ Chroom mat ▣ Metaal/  
 Kunststof

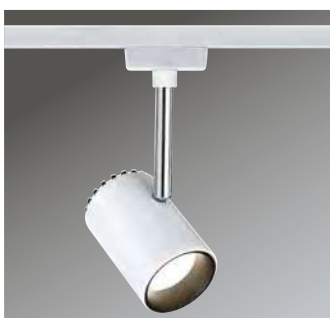

**Spot Shine**  
 incl. 1x4,9 W  
 368 lm, 2.700 K  
 ∠ 75°  
 230 V  
 ⌀180 ⇄59 ⤴90 mm  
 EAN 4000870 952832  
**952.83**  
 ⌘ Weiß ▣ Metall/Kunststoff  
 ⌘ Blanc ▣ Métal/  
 Matière plastique  
 ⌘ Wit ▣ Metaal/Kunststof



**Spot Hemi**  
 incl. 1x4,8 W  
 530 lm, 3.000 K  
 230 V  
 ⌀170 ⇄100 ⤴56 mm  
 EAN 4000870 955086  
**955.08**  
 ⌘ Chrom matt ▣ Metall/  
 Kunststoff  
 ⌘ Chrome mat ▣ Métal/  
 Matière plastique  
 ⌘ Chroom mat ▣ Metaal/  
 Kunststof



**Spot Hemi**  
 incl. 1x4,8 W  
 500 lm, 3.000 K  
 230 V  
 ⌀170 ⇄100 ⤴56 mm  
 EAN 4000870 955093  
**955.09**  
 ⌘ Weiß ▣ Metall/Kunststoff  
 ⌘ Blanc ▣ Métal/  
 Matière plastique  
 ⌘ Wit ▣ Metaal/Kunststof

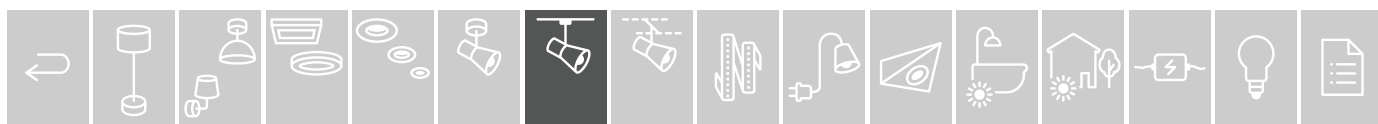

*Spots ohne Leuchtmittel*  
*Spots sans ampoule*  
*Spots zonder verlichtingsmiddelen*



**Spot Tube**  
 max. 10 W, GU10  
 230 V  
 ⌀128 ø65 mm  
 EAN 4000870 969625  
**969.62**  
 ⚡ Chrom matt/Chrom ⚡ Metall/  
 /Kunststoff ⚡ Chrome mat/  
 Chrome ⚡ Métal/Matière  
 plastique ⚡ Chroom mat/Chroom  
 ⚡ Metaal/Kunststof



**Spot Tube**  
 max. 10 W, GU10  
 230 V  
 ⌀128 ø65 mm  
 EAN 4000870 969632  
**969.63**  
 ⚡ Weiß/Chrom matt ⚡ Metall/  
 Kunststoff ⚡ Blanc/Chrome mat  
 ⚡ Métal/Matière plastique  
 ⚡ Wit/Chroom mat ⚡ Metaal/  
 Kunststoff



**Spot Tube**  
 max. 10 W, GU10  
 230 V  
 ⌀128 ø65 mm  
 EAN 4000870 969182  
**969.18**  
 ⚡ Schwarz matt/Chrom ⚡ Metall/  
 /Kunststoff ⚡ Noir mat/Chrome  
 ⚡ Métal/Matière plastique  
 ⚡ Zwart mat/Chroom ⚡ Metaal/  
 Kunststoff

**Spot Pipe**  
 max. 10 W, GU10  
 230 V  
 ⌀150 ø65 ↗100 mm  
 EAN 4000870 976128  
**976.12**  
 ⚡ Chrom matt/Chrom ⚡ Metall/  
 /Kunststoff ⚡ Chrome mat/  
 Chrome ⚡ Métal/Matière  
 plastique ⚡ Chroom mat/Chroom  
 ⚡ Metaal/Kunststof

**Spot Pipe**  
 max. 10 W, GU10  
 230 V  
 ⌀150 ø65 ↗100 mm  
 EAN 4000870 953631  
**953.63**  
 ⚡ Weiß/Chrom ⚡ Metall/  
 Kunststoff ⚡ Blanc/Chrome  
 ⚡ Métal/Matière plastique  
 ⚡ Wit/Chroom ⚡ Metaal/  
 Kunststoff



**Spot Cone**  
 max. 10 W, GU10  
 230 V  
 ⌀180 ø85 ↗90 mm  
 EAN 4000870 976135  
**976.13**  
 ⚡ Chrom matt/Chrom ⚡ Metall/  
 Kunststoff  
 ⚡ Chrome mat/Chrome ⚡ Métal/  
 Matière plastique  
 ⚡ Chroom mat/Chroom  
 ⚡ Metaal/Kunststof



**Spot Cone**  
 max. 10 W, GU10  
 230 V  
 ⌀180 ø85 ↗90 mm  
 EAN 4000870 953624  
**953.62**  
 ⚡ Weiß/Chrom ⚡ Metall/  
 Kunststoff  
 ⚡ Blanc/Chrome ⚡ Métal/  
 Matière plastique  
 ⚡ Wit/Chroom ⚡ Metaal/  
 Kunststoff



**Spot Cone**  
 max. 10 W, GU10  
 230 V  
 ⌀180 ø85 ↗90 mm  
 EAN 4000870 969250  
**969.25**  
 ⚡ Schwarz matt/Chrom  
 ⚡ Metall/Kunststoff  
 ⚡ Noir mat/Chrome ⚡ Métal/  
 Matière plastique  
 ⚡ Zwart mat/Chroom ⚡ Metaal/  
 Kunststoff

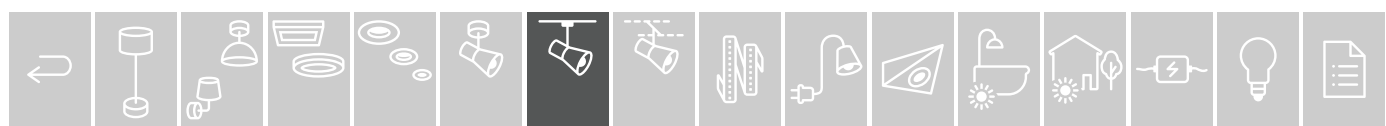

*Spots mit Leuchtmittel*  
*Spots avec ampoule*  
*Spots met verlichtingsmiddel*



**Spot Cone**  
 incl. 1x5 W, GU10  
 330 lm, 2.700 - 6.500 K  
 <math>\sphericalangle</math> 36°  
 230 V  
 <math>\varnothing</math>185 <math>\varnothing</math>85 <math>\varnothing</math>90 mm  
 EAN 4000870 955260  
**955.26 new**

- & Chrom matt/Chrom 

--

 Metall
- & Chrome mat/Chrome 

--

 Métal
- & Chroom mat/Chroom 

--

 Metaal



**Spot Cone**  
 incl. 1x5,5 W, GU10  
 350 lm, 2.700 - 6.500 K  
 <math>\sphericalangle</math> 36°  
 230 V  
 <math>\varnothing</math>180 <math>\varnothing</math>85 <math>\varnothing</math>90 mm  
 EAN 4000870 955253  
**955.25 new**

- & Chrom matt 

--

 Metall/  
Kunststoff
- & Chrome mat 

--

 Métal/  
Matière plastique
- & Chroom mat 

--

 Metaal/  
Kunststof

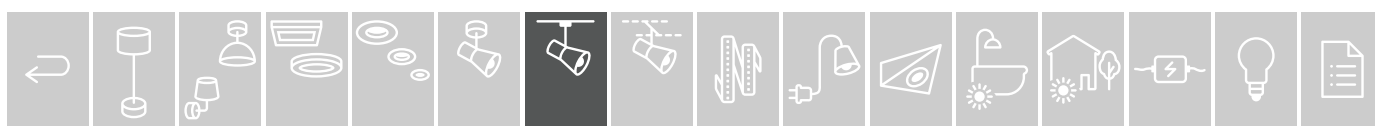

*Spots ohne Leuchtmittel*  
*Spots sans ampoule*  
*Spots zonder verlichtingsmiddelen*



**Spot Pure I**  
 max. 10 W, GU10  
 230 V  
 ⌀110 ⇄58 ⚓66 mm  
 EAN 4000870 953297  
**953.29**  
 ⚡ Chrom matt/Chrom ⏏ Metall/  
 Kunststoff  
 ⚡ Chrome mat/Chrome ⏏ Métal/  
 Matière plastique  
 ⚡ Chroom mat/Chroom  
 ⏏ Metaal/Kunststof



**Spot Pure I**  
 max. 10 W, GU10  
 230 V  
 ⌀110 ⇄58 ⚓66 mm  
 EAN 4000870 953303  
**953.30**  
 ⚡ Weiß/Chrom ⏏ Metall/  
 Kunststoff  
 ⚡ Blanc/Chrome ⏏ Métal/  
 Matière plastique  
 ⚡ Wit/Chroom ⏏ Metaal/  
 Kunststof



**Starter Set Pure II**  
 max. 3×10 W, GU10  
 230 V  
 ⇄1,2 m  
 EAN 4000870 954638  
**954.63**  
 ⚡ Chrom matt/Chrom ⏏ Metall/  
 Kunststoff  
 ⚡ Chrome mat/Chrome ⏏ Métal/  
 Matière plastique  
 ⚡ Chroom mat/Chroom  
 ⏏ Metaal/Kunststof



**Spot Pure II**  
 max. 10 W, GU10  
 230 V  
 ⌀110 ⇄58 ⚓66 mm  
 EAN 4000870 953310  
**953.31**  
 ⚡ Chrom matt/Chrom ⏏ Metall/  
 Kunststoff  
 ⚡ Chrome mat/Chrome ⏏ Métal/  
 Matière plastique  
 ⚡ Chroom mat/Chroom  
 ⏏ Metaal/Kunststof



**Spot Pure II**  
 max. 10 W, GU10  
 230 V  
 ⌀110 ⇄58 ⚓66 mm  
 EAN 4000870 953334  
**953.33**  
 ⚡ Weiß/Chrom ⏏ Metall/  
 Kunststoff  
 ⚡ Blanc/Chrome ⏏ Métal/  
 Matière plastique  
 ⚡ Wit/Chroom ⏏ Metaal/  
 Kunststof



**Spot Pure II**  
 max. 10 W, GU10  
 230 V  
 ⌀151 ⇄58 ⚓66 mm  
 EAN 4000870 969113  
**969.11**  
 ⚡ Schwarz matt ⏏ Metall/  
 Kunststoff  
 ⚡ Noir mat ⏏ Métal/  
 Matière plastique  
 ⚡ Zwart mat ⏏ Metaal/  
 Kunststof

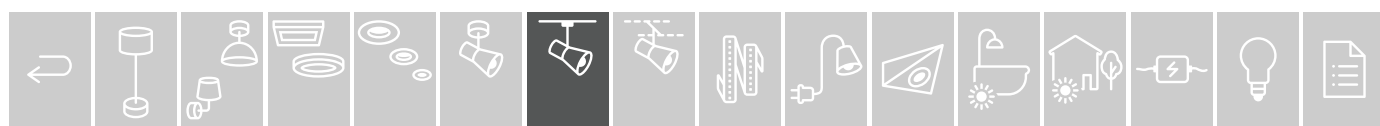



**Starter Set Barelli**

max. 3×10 W, GU10  
230 V  
↔1,2 m  
EAN 4000870 954591  
**954.59**

- ⌘ Chrom matt/Chrom ☒ Metall/  
Kunststoff
- ⌘ Chrome mat/Chrome ☒ Métal/  
Matière plastique
- ⌘ Chroom mat/Chroom  
☒ Metaal/Kunststof



**Spot Barelli**

max. 10 W, GU10  
230 V  
⌀138 ↔68 ⌀35 mm  
EAN 4000870 954614  
**954.61**

- ⌘ Chrom matt/Chrom ☒ Metall/  
Kunststoff
- ⌘ Chrome mat/Chrome ☒ Métal/  
Matière plastique
- ⌘ Chroom mat/Chroom  
☒ Metaal/Kunststof

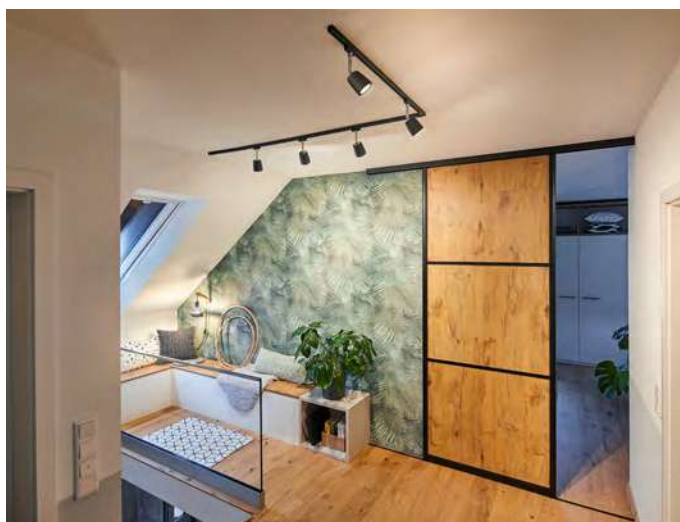

**Starter Set Cover**

max. 3×10 W, GU10  
230 V  
↔1,2 m  
EAN 4000870 954621  
**954.62**

- ⌘ Chrom matt/Chrom ☒ Metall/  
Kunststoff
- ⌘ Chrome mat/Chrome ☒ Métal/  
Matière plastique
- ⌘ Chroom mat/Chroom  
☒ Metaal/Kunststof



**Spot Cover**

max. 10 W, GU10  
230 V  
⌀140 ↔58 ⌀90 mm  
EAN 4000870 953358  
**953.35**

- ⌘ Chrom matt/Chrom ☒ Metall/  
Kunststoff
- ⌘ Chrome mat/Chrome ☒ Métal/  
Matière plastique
- ⌘ Chroom mat/Chroom  
☒ Metaal/Kunststof



**Spot Cover**

max. 10 W, GU10  
230 V  
⌀140 ↔58 ⌀90 mm  
EAN 4000870 953365  
**953.36**

- ⌘ Weiß/Chrom ☒ Metall/  
Kunststoff
- ⌘ Blanc/Chrome ☒ Métal/  
Matière plastique
- ⌘ Wit/Chroom ☒ Metaal/  
Kunststof



**Spot Cover**

max. 10 W, GU10  
230 V  
⌀140 ↔58 ⌀90 mm  
EAN 4000870 969267  
**969.26**

- ⌘ Schwarz matt/Chrom ☒ Metall/  
Kunststoff
- ⌘ Noir mat/Chrome ☒ Métal/  
Matière plastique
- ⌘ Zwart mat/Chroom ☒ Metaal/  
Kunststof

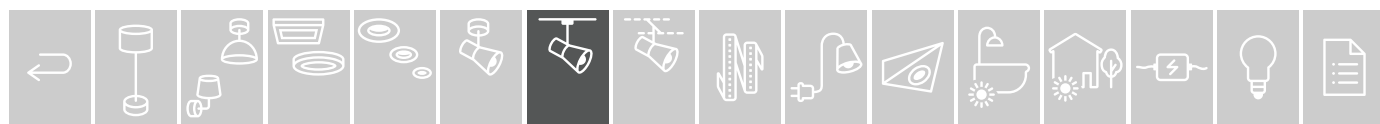



**Spot Blossom**

max. 10 W, G9  
230 V

⌀128 ⇄74 ↗115 mm  
EAN 4000870 953372

**953.37**

- ⌘ Chrom matt/Satin ▣ Metall/  
Glas
- ⌘ Chrome mat/Satiné ▣ Métal/  
Verre
- ⌘ Chroom mat/Satijn ▣ Metaal/  
Glas



**Spot Blossom**

max. 10 W, G9  
230 V

⌀128 ⇄74 ↗115 mm  
EAN 4000870 953426

**953.42**

- ⌘ Weiß/Satin ▣ Metall/Glas
- ⌘ Blanc/Satiné ▣ Métal/Verre
- ⌘ Wit/Satijn ▣ Metaal/Glas



**Spot Blossom**

max. 10 W, G9  
230 V

⌀128 ø65 mm  
EAN 4000870 969663

**969.66**

- ⌘ Schwarz matt/Satin ▣ Metall/  
Glas
- ⌘ Noir mat/Satiné ▣ Métal/Verre
- ⌘ Zwart mat/Satijn ▣ Metaal/  
Glas



Perfect match

□ = 400



**Spot Blossom**

max. 10 W, G9  
230 V

⌀128 ⇄74 ↗115 mm  
EAN 4000870 953396

**953.39**

- ⌘ Chrom matt/Rauchglas  
▣ Metall/Glas
- ⌘ Chrome mat/Verre fumé  
▣ Métal/Verre
- ⌘ Chroom mat/Rookglas  
▣ Metaal/Glas



**Spot Blossom**

max. 10 W, G9  
230 V

⌀128 ⇄74 ↗115 mm  
EAN 4000870 953440

**953.44**

- ⌘ Weiß/Grau transparent  
▣ Metall/Glas
- ⌘ Blanc/Gris transparent  
▣ Métal/Verre
- ⌘ Wit/Grijs transparant  
▣ Metaal/Glas



**Spot Blossom**

max. 10 W, G9  
230 V

⌀128 ø65 mm  
EAN 4000870 969670

**969.67**

- ⌘ Schwarz matt/Rauchglas  
▣ Metall/Glas
- ⌘ Noir mat/Verre fumé ▣ Métal/  
Verre
- ⌘ Zwart mat/Rookglas ▣ Metaal/  
Glas



**Spot Blossom**

max. 10 W, G9  
230 V

⌀128 ⇄74 ↗115 mm  
EAN 4000870 953389

**953.38**

- ⌘ Chrom matt/Klar/Satin  
▣ Metall/Glas
- ⌘ Chrome mat/  
Clair/Satiné ▣ Métal/Verre
- ⌘ Chroom mat/Helder/Satijn  
▣ Metaal/Glas



**Spot Blossom**

max. 10 W, G9  
230 V

⌀128 ⇄74 ↗115 mm  
EAN 4000870 953433

**953.43**

- ⌘ Weiß/Klar/Satin ▣ Metall/Glas
- ⌘ Blanc/Clair/Satiné ▣ Métal/  
Verre
- ⌘ Wit/Helder/Satijn  
▣ Metaal/Glas



*Deckenleuchten mit festverbauter LED*  
*Plafonniers avec LED intégrée fixe*  
*Plafondlampen met vast geïntegreerde LED*



**Panel Loop**

incl. 1x7,64 W  
 1050 lm, 3.000 K  
 230 V  
 ⌀35 ⇄380 ↗110 mm  
 EAN 4000870 953198  
**953.19**



- ⌘ Chrom matt/Chrom ▣ Kunststoff
- ⌘ Chrome mat/Chrome ▣ Matière plastique
- ⌘ Chroom mat/Chroom ▣ Kunststof

**Panel Loop**

incl. 1x7,64 W  
 1050 lm, 2.700 K  
 230 V  
 ⌀35 ⇄380 ↗110 mm  
 EAN 4000870 953204  
**953.20**



- ⌘ Weiß/Chrom ▣ Kunststoff
- ⌘ Blanc/Chrome ▣ Matière plastique
- ⌘ Wit/Chroom ▣ Kunststof

**Panel Loop**

incl. 1x7,64 W  
 1050 lm, 2.700 K  
 230 V  
 ⌀35 ⇄380 ↗110 mm  
 EAN 4000870 969205  
**969.20**



- ⌘ Schwarz matt/Chrom ▣ Alu/Kunststoff
- ⌘ Noir mat/Chrome ▣ Alu/Matière plastique
- ⌘ Zwart mat/Chroom ▣ Alu/Kunststof



**Safira**

incl. 1x4,9 W  
 440 lm, 2.700 K  
 230 V  
 ⌀136 ø80 ⇄80 mm  
 EAN 4000870 955017  
**955.01**



- ⌘ Chrom/Klar/Satin ▣ Metall/Acryl
- ⌘ Chrome/Clair/Satiné ▣ Métal/Acryl
- ⌘ Chroom/Helder/Satijn ▣ Metaal/Acryl



**Topa**

incl. 1x4,9 W  
 400 lm, 2.700 K  
 230 V  
 ⌀73 ø80 ⇄80 mm  
 EAN 4000870 955024  
**955.02**



- ⌘ Chrom/Klar/Satin ▣ Metall/Acryl
- ⌘ Chrome/Clair/Satiné ▣ Métal/Acryl
- ⌘ Chroom/Helder/Satijn ▣ Metaal/Acryl

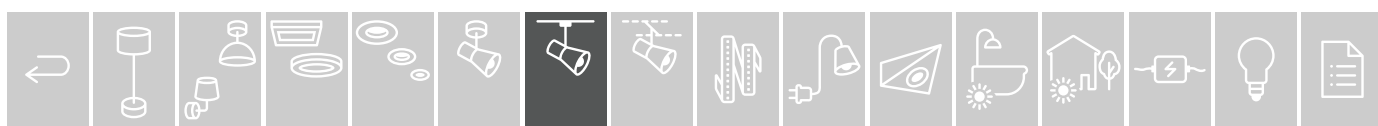



Deckenleuchten ohne Leuchtmittel  
Plafonniers sans ampoule  
Plafondlampen zonder verlichtingsmiddelen



Perfect match

☐=412-432



Perfect match

☐=430-431



**Ceiling Socket**

max. 20 W, E27

230 V

⤴96 ø55 mm

EAN 4000870 949733

**949.73**

- ☞ Chrom matt ☐ Metall
- ☞ Chrome mat ☐ Métal
- ☞ Chroom mat ☐ Metaal



**Ceiling Socket**

max. 20 W, E27

230 V

⤴96 ø55 mm

EAN 4000870 949740

**949.74**

- ☞ Weiß ☐ Metall
- ☞ Blanc ☐ Métal
- ☞ Wit ☐ Metaal



**Ceiling Socket**

max. 20 W, E27

230 V

⤴96 ø55 mm

EAN 4000870 949757

**949.75**

- ☞ Schwarz ☐ Metall
- ☞ Noir ☐ Métal
- ☞ Zwart ☐ Metaal



**Ceiling Globe Small**

max. 10 W, E14

230 V

⤴320 ø200 mm

EAN 4000870 976029

**976.02**

- ☞ Chrom matt/Opal ☐ Metall/  
Glas
- ☞ Chrome mat/Opale ☐ Métal/  
Verre
- ☞ Chroom mat/Opaal ☐ Metaal/  
Glas

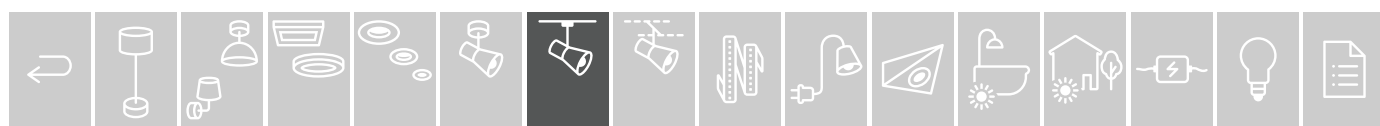
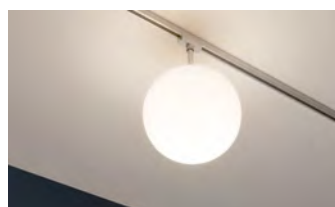

*Pendelleuchten mit festverbauter LED*  
*Suspensions avec LED intégrée fixe*  
*Hanglampen met vast geïntegreerde LED*

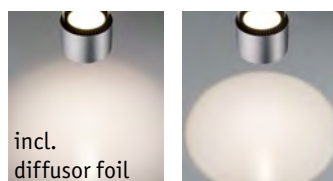

incl.  
diffusor foil

∠ 100°



∠ 80°

**Pendulum Aldan**

incl. 1x8,3 / 1x4,6 W  
840 + 450 lm, 2.700 K  
230 V

∅85 mm ∅20-150 cm  
∅98 mm

EAN 4000870 955208

**955.20**

- ☞ Chrom matt/Schwarz
- ☞ Metall/Kunststoff
- ☞ Chrome mat/Noir ☞ Metall/  
Kunststoff
- ☞ Chrom mat/Zwart ☞ Metall/  
Kunststoff



**Pendulum Aldan**

incl. 1x8,3 / 1x4,6 W  
840 + 450 lm, 2.700 K  
230 V

∅85 mm ∅20-150 cm  
∅98 mm

EAN 4000870 949719

**949.71**

- ☞ Weiß ☞ Metall
- ☞ Blanc ☞ Métal
- ☞ Wit ☞ Metaal



**Pendulum Aldan**

incl. 1x8,3 / 1x4,6 W  
840 + 450 lm, 2.700 K  
230 V

∅85 mm ∅20-150 cm  
∅98 mm

EAN 4000870 949726

**949.72**

- ☞ Schwarz matt ☞ Metall
- ☞ Noir mat ☞ Métal
- ☞ Zwart mat ☞ Metaal





**LED Pendulum Barrel**

incl. 1x6,6 W  
626 lm, 2.700 K  
∠ 106°, 139 cd  
230 V  
↑135 cm ø85 mm  
EAN 4000870 951774  
**951.77**



- ⌘ Chrom matt/Alu eloxiert
- ⌘ Metall/Kunststoff
- ⌘ Chrome mat/Alu anodisé
- ⌘ Métal/Matière plastique
- ⌘ Chroom mat/Alu geëloxeerd
- ⌘ Metaal/Kunststof

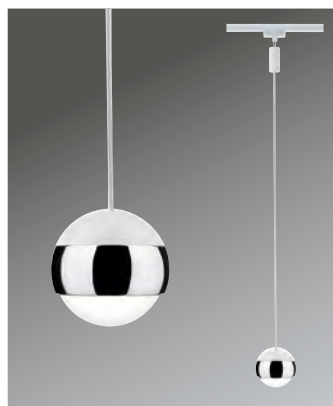

**Pendulum Capsule II**

incl. 1x6,3 W  
445 lm, 2.700 K  
230 V  
↑130 cm ø87 mm  
EAN 4000870 954577  
**954.57**



- ⌘ Chrom matt/Chrom ⌘ Metall/Kunststoff
- ⌘ Chrome mat/Chrome ⌘ Métal/Matière plastique
- ⌘ Chroom mat/Chroom ⌘ Metaal/Kunststof

**Pendulum Capsule II**

incl. 1x6,3 W  
445 lm, 2.700 K  
230 V  
↑130 cm ø87 mm  
EAN 4000870 954584  
**954.58**



- ⌘ Weiß/Chrom ⌘ Metall/Kunststoff
- ⌘ Blanc/Chrome ⌘ Métal/Matière plastique
- ⌘ Wit/Chroom ⌘ Metaal/Kunststof

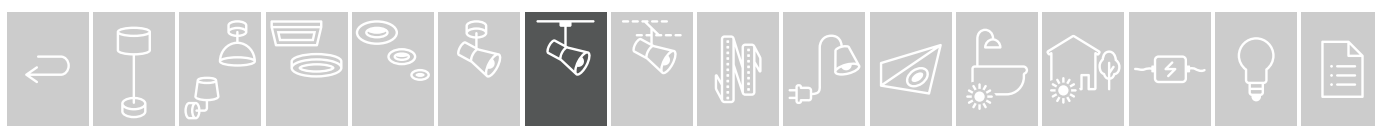

*Pendelleuchten ohne Leuchtmittel*  
*Suspensions sans ampoule*  
*Hanglampen zonder verlichtingsmiddelen*



**Pendulum Arido II**

incl. 1x5 W, GU10  
 560 lm, 2.700 K  
 230 V  
 ⚡200 mm ⚡158 cm ø110 mm  
 EAN 4000870 949986  
**949.98**

- ⚡ Chrom matt/Klar/Satin
- ⚡ Glas/Metall
- ⚡ Chrome mat/Clair/Satiné
- ⚡ Verre/Métal
- ⚡ Chroom mat/Helder/Satijn
- ⚡ Glas/Metaal

**Pendulum Catalejo**

max. 10W, GU10  
 230 V  
 ⚡383 mm ⚡160 cm ø65 mm  
 EAN 4000870 969588

- 969.58**
- ⚡ Chrom matt ⚡ Metall
  - ⚡ Chrome mat ⚡ Métal
  - ⚡ Chroom mat ⚡ Metaal

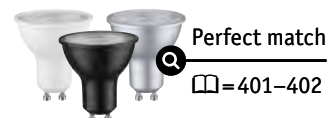

**Pendulum Sarrasani**

max. 20 W, E14  
 230 V  
 ⚡140 cm  
 EAN 4000870 969755  
**969.75**

- ⚡ Chrom matt/Dichroic ⚡ Metall/Glas
- ⚡ Chrome mat/Dichroïque ⚡ Métal/Verre
- ⚡ Chroom mat/Dichroïsch ⚡ Metaal/Glas

**Pendulum Sarrasani**

max. 20 W, E14  
 230 V  
 ⚡140 cm  
 EAN 4000870 969762  
**969.76**

- ⚡ Schwarz matt/Dichroic ⚡ Metall/Glas
- ⚡ Noir mat/Dichroïque ⚡ Métal/Verre
- ⚡ Zwart mat/Dichroïsch ⚡ Metaal/Glas

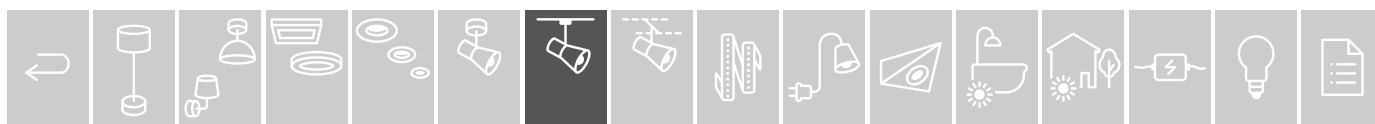



**Pendulum Sarrasani**

max. 20 W, E14  
230 V  
140 cm  
EAN 4000870 969724  
**969.72**

- 🔗 Chrom matt/Opal 📦 Metall/Glas
- 🔗 Chrome mat/Opale 📦 Métal/Verre
- 🔗 Chroom mat/Opaal 📦 Metaal/Glas



**Pendulum Sarrasani**

max. 20 W, E14  
230 V  
140 cm  
EAN 4000870 969731  
**969.73**

- 🔗 Weiß/Opal 📦 Metall/Glas
- 🔗 Blanc/Opale 📦 Métal/Verre
- 🔗 Wit/Opaal 📦 Metaal/Glas



**Pendulum Sarrasani**

max. 20 W, E14  
230 V  
140 cm  
EAN 4000870 969748  
**969.74**

- 🔗 Schwarz matt/Opal 📦 Metall/Glas
- 🔗 Noir mat/Opale 📦 Métal/Verre
- 🔗 Zwart mat/Opaal 📦 Metaal/Glas

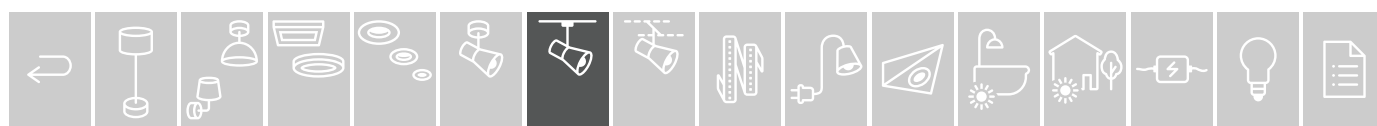

*Kombinieren Sie selbst Ihr persönliches Lichtsystem*  
*Composez vous-même votre système d'éclairage personnel*  
*Combineer uw persoonlijk lichtstelsel zelf*

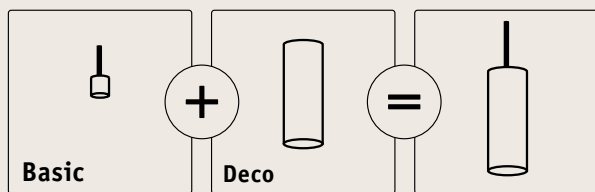

Perfect match  
 □ = 412-432





Perfect match  
 □ = 430-431





**Pendulum Alari**  
 max. 20 W, E27  
 230 V  
 ⚙️ 150 cm  
 EAN 4000870 954362  
**954.36**

- 🔩 Chrom matt/Chrom
- 📏 Metall/Kunststoff
- 🔩 Chrome mat/Chrome
- 📏 Métal/Matière plastique
- 🔩 Chroom mat/Chroom
- 📏 Metaal/Kunststof





**Pendulum Alari**  
 max. 20 W, E27  
 230 V  
 ⚙️ 150 cm  
 EAN 4000870 954379  
**954.37**

- 🔩 Weiß/Chrom
- 📏 Metall/Kunststoff
- 🔩 Blanc/Chrome
- 📏 Métal/Matière plastique
- 🔩 Wit/Chroom
- 📏 Metaal/Kunststof

**Pendulum Alari**  
 max. 20 W, E27  
 230 V  
 ⚙️ 150 cm  
 EAN 4000870 969199  
**969.19**

- 🔩 Schwarz matt/Chrom
- 📏 Metall/Kunststoff
- 🔩 Noir mat/Chrome
- 📏 Métal/Matière plastique
- 🔩 Zwart mat/Chroom
- 📏 Metaal/Kunststof

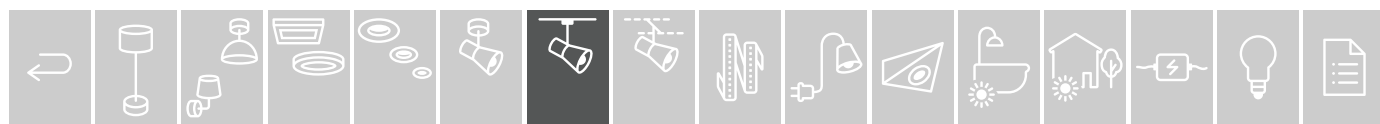

**2Easy Alari**

max. 20 W  
 ø300 mm  
 EAN 4000870 954447  
**954.44**

- ☞ Opal ☐ Glas
- ☞ Opale ☐ Verre
- ☞ Opaal ☐ Glas



**2Easy Alari**

max. 20 W  
 ø300 mm  
 EAN 4000870 954454  
**954.45**

- ☞ Satin/Klar ☐ Glas
- ☞ Satiné/Clair ☐ Verre
- ☞ Satijn/Helder ☐ Glas



**Shade Pirm**

max. 20 W  
 ⚡230 ø280 mm  
 EAN 4000870 954409  
**954.40**

- ☞ Grau matt ☐ Metall
- ☞ Gris dépoli ☐ Métal
- ☞ Grijs mat ☐ Metaal



**Shade Pien**

max. 20 W  
 ⚡230 ø250 mm  
 EAN 4000870 954423  
**954.42**

- ☞ Beige matt ☐ Metall
- ☞ Beige dépoli ☐ Métal
- ☞ Beige mat ☐ Metaal



**Shade Pom**

max. 20 W  
 ⚡240 ø350 mm  
 EAN 4000870 954386  
**954.38**

- ☞ Weiß matt ☐ Metall
- ☞ Blanc dépoli ☐ Métal
- ☞ Wit mat ☐ Metaal



**Vento**

⚡280 ø170 mm  
 EAN 4000870 953518  
**953.51**

- ☞ Klar ☐ Glas
- ☞ Clair ☐ Verre
- ☞ Helder ☐ Glas



**Drio**

⚡280 ø152 mm  
 EAN 4000870 953525  
**953.52**

- ☞ Rauchglas ☐ Glas
- ☞ Verre fumé ☐ Verre
- ☞ Rookglas ☐ Glas



**Vento**

⚡280 ø170 mm  
 EAN 4000870 953549  
**953.54**

- ☞ Opal ☐ Glas
- ☞ Opale ☐ Verre
- ☞ Opaal ☐ Glas

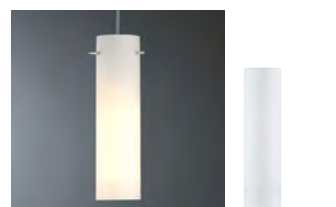

**Livo**

⚡280 ø75 mm  
 EAN 4000870 998427  
**998.42**

- ☞ Opal ☐ Glas
- ☞ Opale ☐ Verre
- ☞ Opaal ☐ Glas



**Tessa**

max. 50 W  
 ⚡260 ø454 mm  
 EAN 4000870 954652  
**954.65**

- ☞ Hellgrau ☐ Stoff
- ☞ Gris clair ☐ Tissus
- ☞ Lichtgrijs ☐ Textiel



**Tessa**

max. 50 W  
 ⚡260 ø454 mm  
 EAN 4000870 954669  
**954.66**

- ☞ Creme ☐ Stoff
- ☞ Crème ☐ Tissus
- ☞ Crème ☐ Textiel



**2Easy Diffusor**

max. 20 W  
 ø454 mm  
 EAN 4000870 954928  
**954.92**

- ☞ Satin ☐ Kunststoff
- ☞ Satiné ☐ Matière plastique
- ☞ Satijn ☐ Kunststof

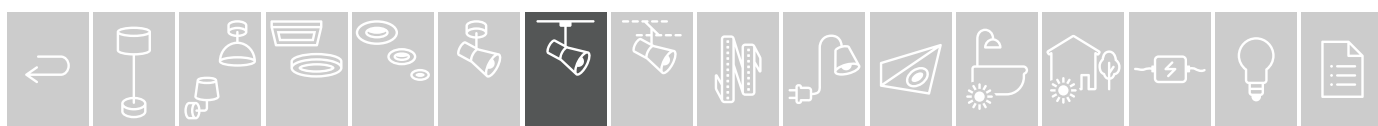



**LED End Cap**

incl. 1x5,3 W  
440 lm, 2.700 K  
∠ 80°  
230 V  
∅27 ⇄141 ∅57 mm  
EAN 4000870 954799

**954.79**

- 🔗 Chrom matt 🗄 Metall
- 🔗 Chrome mat 🗄 Métal
- 🔗 Chrom mat 🗄 Metaal



**LED End Cap**

incl. 1x5,3 W  
440 lm, 2.700 K  
∠ 80°  
230 V  
∅27 ⇄141 ∅57 mm  
EAN 4000870 954805

**954.80**

- 🔗 Weiß 🗄 Metall
- 🔗 Blanc 🗄 Métal
- 🔗 Wit 🗄 Metaal



**LED Line Connector**

incl. 1x5,3 W  
440 lm, 2.700 K  
∠ 80°  
230 V  
∅27 ⇄189 ∅57 mm  
EAN 4000870 954775

**954.77**

- 🔗 Chrom matt 🗄 Metall
- 🔗 Chrome mat 🗄 Métal
- 🔗 Chrom mat 🗄 Metaal



**LED Line Connector**

incl. 1x5,3 W  
440 lm, 2.700 K  
∠ 80°  
230 V  
∅27 ⇄189 ∅57 mm  
EAN 4000870 954782

**954.78**

- 🔗 Weiß 🗄 Metall
- 🔗 Blanc 🗄 Métal
- 🔗 Wit 🗄 Metaal

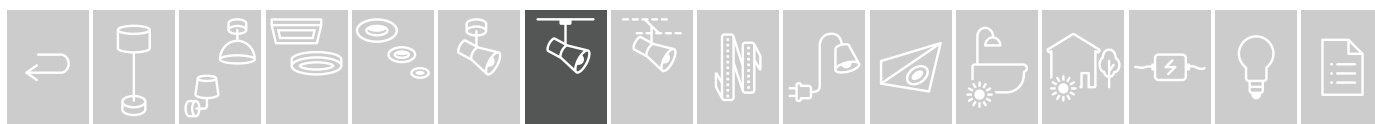





**LED L-Connector**

incl. 1x5,3 W  
440 lm, 2.700 K  
∠ 80°  
230 V  
⌀27 ⇄141 ⇄141 mm  
EAN 4000870 954850

**954.85** 📦

- 🔩 Chrom matt 📦 Metall
- 🔩 Chrome mat 📦 Métal
- 🔩 Chrom mat 📦 Metaal



**LED L-Connector**

incl. 1x5,3 W  
440 lm, 2.700 K  
∠ 80°  
230 V  
⌀27 ⇄141 ⇄141 mm  
EAN 4000870 954867

**954.86** 📦

- 🔩 Weiß 📦 Metall
- 🔩 Blanc 📦 Métal
- 🔩 Wit 📦 Metaal



**LED T-Connector**

incl. 1x5,3 W  
440 lm, 2.700 K  
∠ 80°  
230 V  
⌀27 ⇄224 ⇄141 mm  
EAN 4000870 954836

**954.83** 📦

- 🔩 Chrom matt 📦 Metall
- 🔩 Chrome mat 📦 Métal
- 🔩 Chrom mat 📦 Metaal

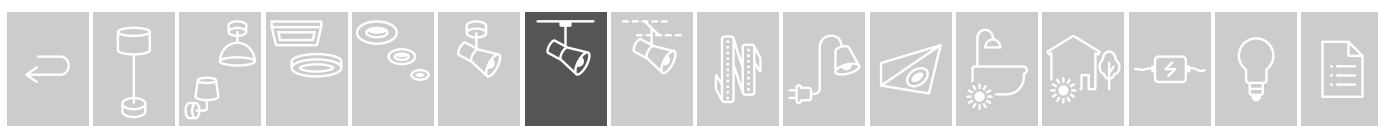

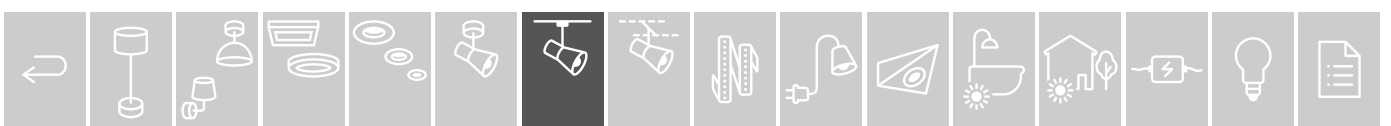
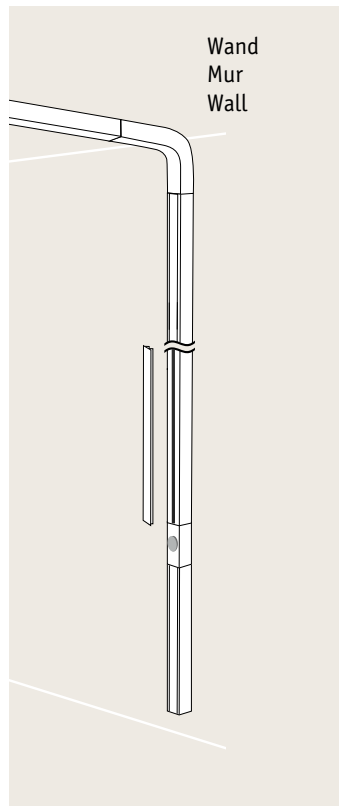
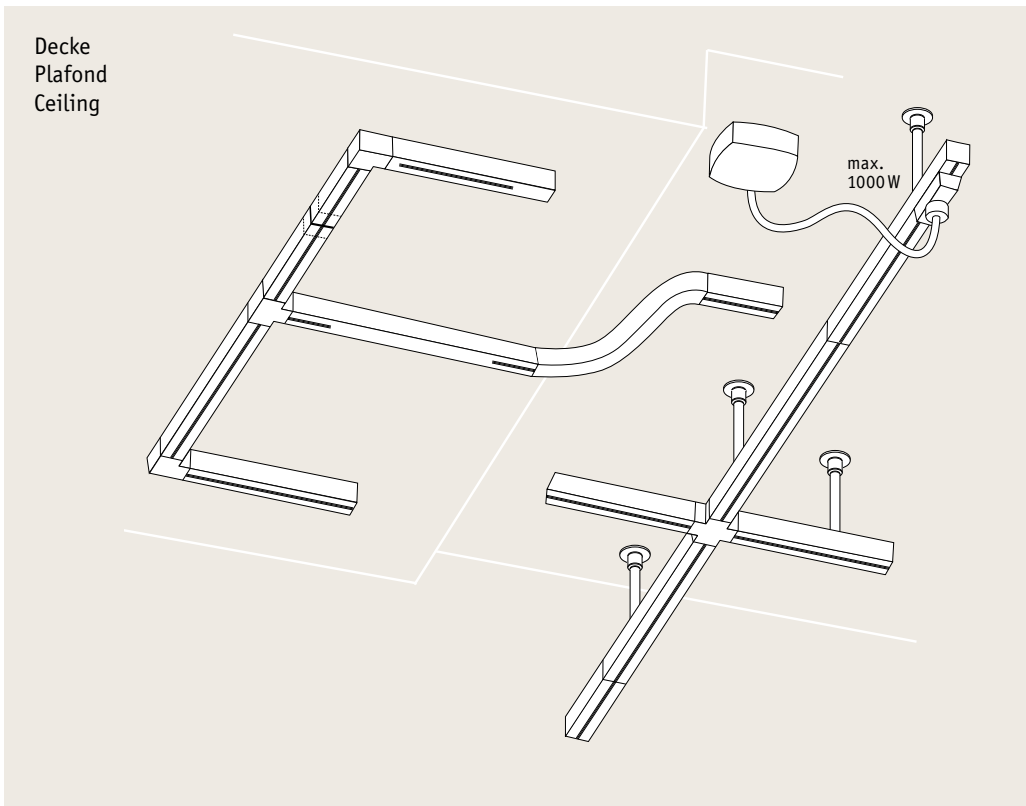



**Schiene  
Rail  
Rail**

max. 1,000 W  
 $\updownarrow$ 18 mm  $\nearrow$ 18 mm



**CM**  $\leftrightarrow$ 0,1 m  
 EAN 4000870 950869  
**950.86**

**W**  $\leftrightarrow$ 0,1 m  
 EAN 4000870 954980  
**954.98**

**B**  $\leftrightarrow$ 0,1 m  
 EAN 4000870 969021  
**969.02**

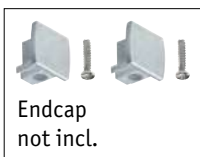

**CM**  $\leftrightarrow$ 0,5 m  
 EAN 4000870 968543  
**968.54**

**W**  $\leftrightarrow$ 0,5 m  
 EAN 4000870 976821  
**976.82**

**B**  $\leftrightarrow$ 0,5 m  
 EAN 4000870 969038  
**969.03**



**CM**  $\leftrightarrow$ 1 m  
 EAN 4000870 968338  
**968.33**

**W**  $\leftrightarrow$ 1 m  
 EAN 4000870 976838  
**976.83**

**B**  $\leftrightarrow$ 1 m  
 EAN 4000870 969045  
**969.04**



**CM**  $\leftrightarrow$ 2 m  
 EAN 4000870 968345  
**968.34**

**W**  $\leftrightarrow$ 2 m  
 EAN 4000870 976845  
**976.84**

**B**  $\leftrightarrow$ 2 m  
 EAN 4000870 969052  
**969.05**



**Urail Safety Cover Strip**  
 $\nearrow$ 10 mm  $\leftrightarrow$ 68 cm

**W**  
 EAN 4000870 951262  
**951.26**

**B**  
 EAN 4000870 954157  
**954.15 new**



**Universal Endcap 2-Pack**  
 $\updownarrow$ 18  $\leftrightarrow$ 13  $\nearrow$ 21 mm

**CM**  
 EAN 4000870 954966  
**954.96**

**W**  
 EAN 4000870 954973  
**954.97**

**B**  
 EAN 4000870 969618  
**969.61**



**Suspension 105 mm  
Support tubes  
Ophanging**  
 $\updownarrow$ 105  $\varnothing$ 23 mm

**CM**  
 EAN 4000870 975992  
**975.99**

**W**  
 EAN 4000870 976883  
**976.88**



**Suspension 125/250 mm**  
 $\updownarrow$ 125/250  $\leftrightarrow$ 18 mm

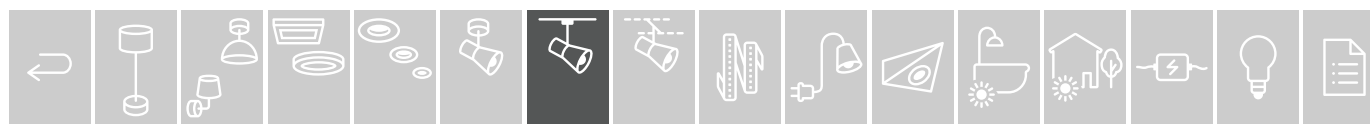
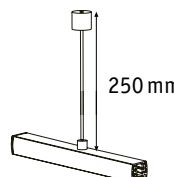
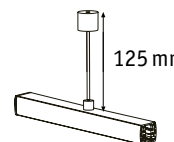

**W**  
 EAN 4000870 951491  
**951.49**





**Line Connector**

max. 1,000 W  
 ⌀15 ⇄70 ↗11 mm

 EAN 4000870 951361  
**951.36** 

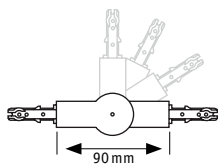

**Angle Connector**

max. 1,000 W  
 ⌀18 ⇄159 ↗36 mm

**CM** EAN 4000870 969649 **969.64**  
**W** EAN 4000870 969656 **969.65**  
**B** EAN 4000870 969090 **969.09** 



29 mm

**L-Verbinder  
 L-Connecteur  
 L-Verbinding**

max. 1,000 W  
 ⌀18 ⇄62 ↗62 mm

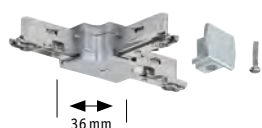

**CM** EAN 4000870 976487 **976.48**  
**W** EAN 4000870 976494 **976.49**  
**B** EAN 4000870 969099 **969.06** 



36 mm

**T-Verbinder  
 T-Connecteur  
 T-Verbinding**

max. 1,000 W  
 ⌀18 ⇄104 ↗62 mm



**CM** EAN 4000870 976562 **976.56**   
**W** EAN 4000870 976869 **976.86**   
**B** EAN 4000870 969076 **969.07** 



36 mm

**X-Verbinder  
 X-Connecteur  
 X-Verbinding**

max. 1,000 W  
 ⌀18 ⇄104 ↗104 mm

**CM** EAN 4000870 976579 **976.57**   
**W** EAN 4000870 976876 **976.87**   
**B** EAN 4000870 969083 **969.08** 

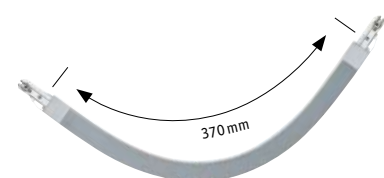

370 mm

**Verbinder Maxiflex  
 Connecteur Maxiflex  
 Verbinding Maxiflex**

max. 1,000 W  
 ⌀18 ⇄440 ↗18 mm

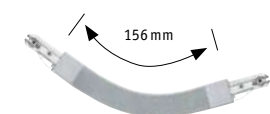

**CM** EAN 4000870 953273  
**953.27** 



156 mm

**Flex Verbinder II  
 Connecteur flexible II  
 Verbinding flexibel II**

max. 1,000 W  
 ⌀18 ⇄227 ↗18 mm

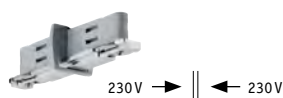

**CM** EAN 4000870 953259 **953.25**   
**W** EAN 4000870 953266 **953.26**   
**B** EAN 4000870 969106 **969.10** 



230V → || ← 230V

**Stromtrenner  
 Séparateur de circuit  
 Stroomonderbreker**

⌀18 ⇄70 ↗18 mm

 EAN 4000870 951408  
**951.40** 

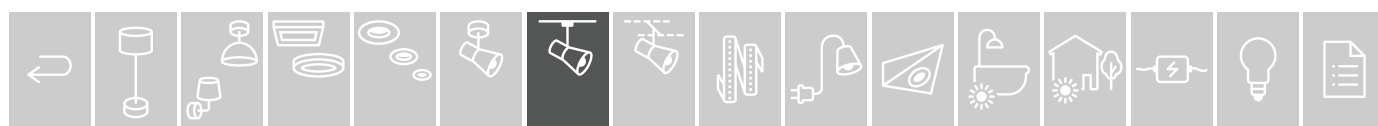



230V →

not incl.  
line connector



230V

**Endeinspeisung**  
**Alimentation de fin de ligne**  
**Eindvoeding**

max. 1.000W  
⌀18 ⇄161 ↻18 mm

**CM**

EAN 4000870 976555  
**976.55** 📦

**W**

EAN 4000870 976852  
**976.85** 📦

**B**

EAN 4000870 969601  
**969.60** 📦



not incl.  
line connector

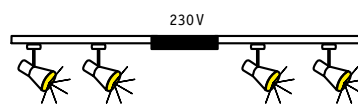

230V

**Mittel- / Endeinspeisung**  
**Alimentation en milieu / fin de circuit**  
**Midden- / eindvoeding**

max. 1.000W  
⌀27 ⇄205 ↻45 mm

**CM**

EAN 4000870 968857  
**968.85** 📦

**W**

EAN 4000870 968864  
**968.86** 📦

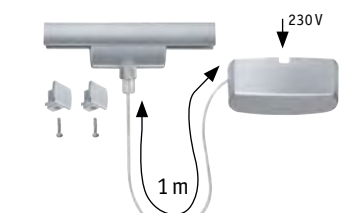

230V

1 m

not incl.  
line connector

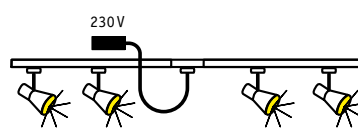

230V

**Mittel- / Endeinspeisung**  
**Alimentation en milieu / fin de circuit**  
**Midden- / eindvoeding**

max. 1.000W  
⌀30 mm ø75 mm ⇄165 mm

**CM**

EAN 4000870 968314  
**968.31** 📦

**W**

EAN 4000870 976791  
**976.79** 📦

**B**

EAN 4000870 969168  
**969.16** 📦

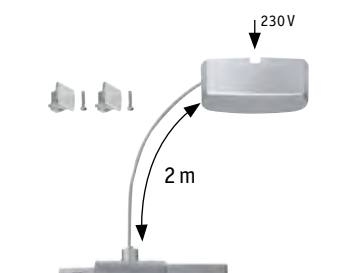

230V

2 m

not incl.  
line connector

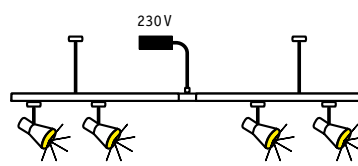

230V

**Mittel- / Endeinspeisung**  
**Alimentation en milieu / fin de circuit**  
**Midden- / eindvoeding**

max. 1.000W  
⌀30 mm ⇄80 mm ↻80 mm ⇄2 m

**CM**

EAN 4000870 954164  
**954.16** new

**W**

EAN 4000870 954171  
**954.17** new

**B**

EAN 4000870 954188  
**954.18** new

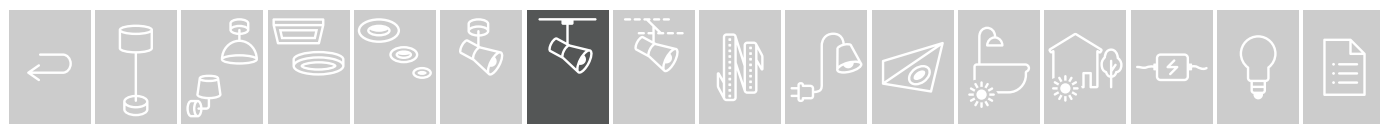



- ▶ Mittel-Einspeisung in Schienen-Form mit separat schaltbaren Ausgängen
- ▶ Für Hausinstallationen mit 4/5-adriger Verkabelung und Serienschalter
- ▶ Mit Kabelbrücke auch für 3-adrige Verkabelung mit Wechselschalter geeignet (dann nicht separat schaltbar)

- ▶ Alimentation en milieu de circuit en forme de rail avec des sorties commutables séparément
- ▶ Destiné aux systèmes pour les installations domestiques avec câblage à 4/5 fils et un commutateur
- ▶ Avec un passage pour câblage à max. 3 fils et commutateur adapté (dans ce cas, non commutables séparément)

- ▶ Middenvoeding in railvorm met apart schakelbare uitgangen
- ▶ Voor huisinstallaties met 4/5-aderige bekabeling en serieschakelaar
- ▶ Met kabelbrug ook geschikt voor 3-aderige bekabeling met wisselschakelaar (dan niet apart schakelbaar)

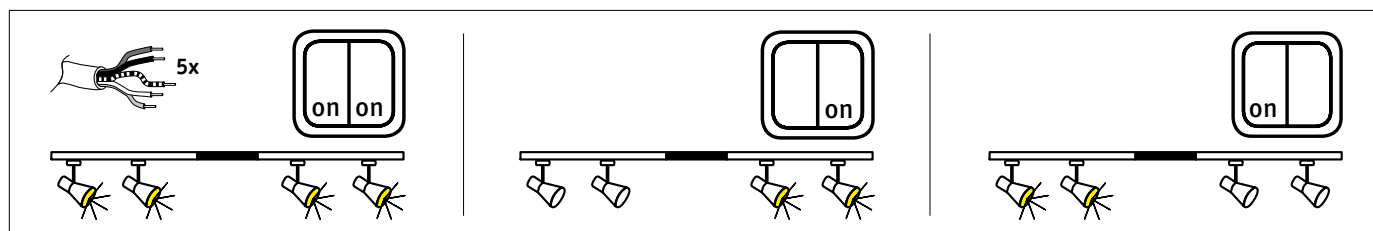
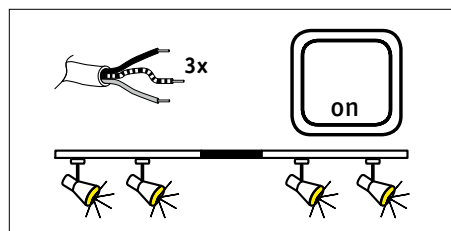

**URail Middle-Feed**

max. 1,000/1,000 W  
 ⚡18 ↔304 ↻18 mm

**CM**

EAN 4000870 977651  
**977.65**

**W**

EAN 4000870 977668  
**977.66**

**B**

EAN 4000870 969212  
**969.21**

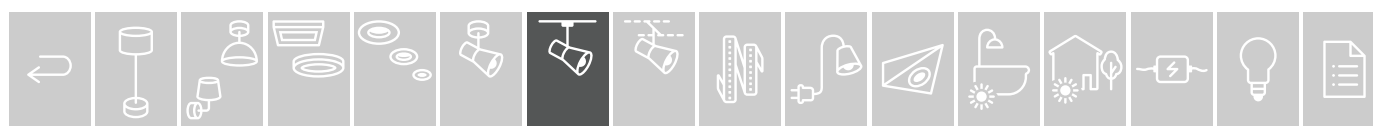



► Zum Einbinden von Pendeln ohne URail Anschluss.

► Pour intégrer des suspensions sans raccord URail.

► Om pendels zonder URail-aansluiting te integreren.

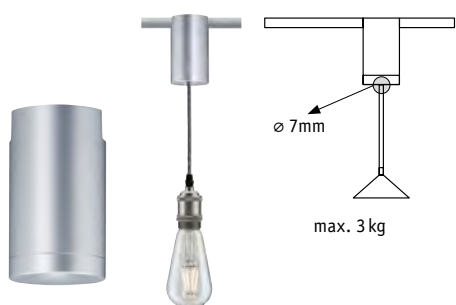

**Universal Pendant Adapter**

max. 100 W  
 ⚡106 ⌀62 mm

**CM**

EAN 4000870 954942  
**954.94**

**W**

EAN 4000870 954959  
**954.95**

**B**

EAN 4000870 955536  
**955.53 new**

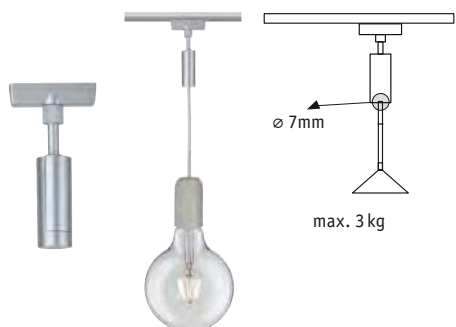

**Universal Pendant Adapter**

max. 50 W  
 ⚡124 ⌀23 ⚡57,5 mm

**CM**

EAN 4000870 955512  
**955.51 new**

**W**

EAN 4000870 955529  
**955.52 new**

**B**

EAN 4000870 969144  
**969.14**

- Pendeladapter zum Kürzen ohne zu schneiden.
- Das Pendelkabel wird in dem Adapter aufgewickelt (max. 1m)

- Raccourcir l'adaptateur de suspension sans le couper.
- Le câble de la suspension est enroulé dans l'adaptateur (max. 1 m)

- Met de pendeladapter kunnen hanglampen zonder snijden worden ingekort.
- De pendelkabel wordt gewoon in de adapter opgewikkeld (max. 1m).

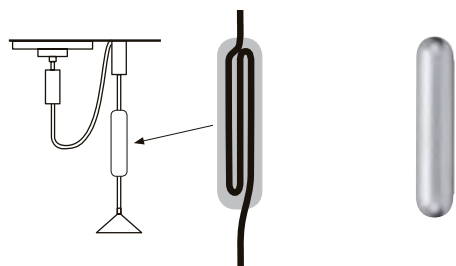

**Adapter für Pendel, kürzbar  
 Adaptateur pour suspension, réglable  
 Adapter voor pendel, kan verkort worden**

⚡135 ⌀26 mm

**CM**



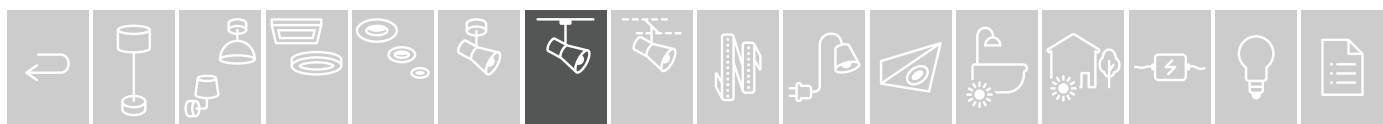



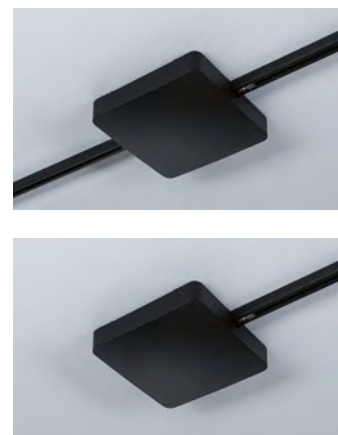



EAN 4000870 974742  
**974.74**











- ▶ Schaltet und dimmt nachfolgende Abschnitte
- ▶ Verwendbar mit Paulmann Zigbee Fernbedienung oder u.g. kompatiblen Systemen
- ▶ Commute et atténue les sections suivantes
- ▶ Utilisable avec la télécommande Paulmann Zigbee ou les systèmes compatibles ci-dessous
- ▶ Schakelt en dimt de volgende delen
- ▶ Te gebruiken met de Paulmann ZigBee afstandsbediening of de hieronder genoemde compatibele systemen

	<b>URail Dimm/Switch Adapter</b>	<b>CM</b>	<b>W</b>	<b>B</b>	
	max. 400 W 230 V Ω max. 400 W, C max. 150 W, ⌀35 ⇄155 ⌀56 mm	   	EAN 4000870 500507 <b>500.50</b>	EAN 4000870 500514 <b>500.51</b>	EAN 4000870 968154 <b>968.15 new</b>
	<b>Middle/End feed</b>	<b>CM</b>	<b>W</b>	<b>B</b>	
	max. 300 W ⌀48 ⇄227 ⌀196 mm	   	EAN 4000870 501207 <b>501.20 new</b>	EAN 4000870 501214 <b>501.21 new</b>	EAN 4000870 968192 <b>968.19 new</b>

- ▶ Ermöglicht die Steuerung von Einzelköpfen und Gruppenschaltungen, sodass verschiedene Lichtszenarien geschaltet werden können (wie bei einem 2 Phasen-Schienensystem)
- ▶ Verwendbar mit Paulmann Zigbee Fernbedienung oder u. g. kompatiblen Systemen
- ▶ Permet de contrôler des têtes séparées et des commandes groupées, de sorte les divers scénarios d'éclairage puissent être commutés (comme pour un système sur rail biphasé)
- ▶ Utilisable avec la télécommande Paulmann Zigbee ou les systèmes compatibles ci-dessous
- ▶ Maakt de besturing van afzonderlijke elementen en groepsschakelingen mogelijk, zodat verschillende lichtscenario's kunnen worden geschakeld (zoals bij een 2-fasenrailsysteem)
- ▶ Te gebruiken met de Paulmann ZigBee afstandsbediening of de hieronder genoemde compatibele systemen

	<b>ZB Spot Adapter</b>	<b>CM</b>
	max. 50 W ⌀50 ⇄166 ⌀20 mm	   
		EAN 4000870 968932 <b>968.93</b>

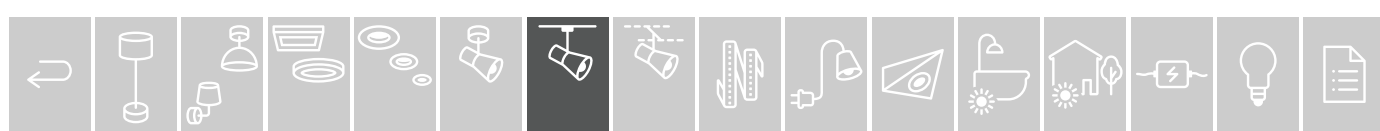

# Wire Systems CorDuo

186 LED 12V DC BLE

187 LED 12V DC

204 12V AC

208 DecoSystems

210 Accessories



192

## CorDuo: schwebendes Licht auf filigranen Seilen

Die neu konzipierten Seilsysteme schaffen elegante Beleuchtung selbst in schwierigen Raumsituationen. Egal ob Balken, Stuckdecken, Dachschrägen oder Dachgeschoss, Schrägen und Ecken lassen sich problemlos überwinden und das Licht mit nur einem Stromanschluss im kompletten Raum verteilen. Die Komplett-Sets sind leicht durch einzelne Spots erweiterbar und kommen in den modernen und matten Systemfarben Chrom, Weiß und Schwarz daher. Nicht nur die modern designten Spots, auch die Seile selbst, Zubehörteile und die flachen und leichten Trafos harmonisieren durch diese einheitliche Farbgebung.

## CorDuo : lumière flottante sur des câbles fins

Les systèmes câbles nouvellement conçus créent un éclairage élégant, même dans des structures difficiles. Qu'il s'agisse de poutres, de plafonds en stuc, de mansardes ou de combles, les plans inclinés et les angles peuvent être contournés sans problème et la lumière peut être distribuée dans toute la pièce avec une seule prise. Les kits complets sont facilement extensibles avec des spots individuels et sont disponibles dans les couleurs modernes et mates du système : chrome, blanc et noir. Non seulement les spots au design moderne, mais aussi les câbles eux-mêmes, les accessoires et les transfos plats et légers s'accordent grâce à cette palette de couleurs homogène.

## CorDuo: zwevend licht aan filigraankabels

De herziene kabelsystemen creëren elegante verlichting, zelfs onder moeilijke ruimtelijke omstandigheden. Of het nu om balken, stucplafonds, schuine plafonds of de zolder gaat; schuine wanden en hoeken zijn probleemloos te overwinnen en het licht kan met slechts één stroomaansluiting in de hele ruimte worden verdeeld. De complete sets zijn gemakkelijk uit te breiden met afzonderlijke spots en worden geleverd in de moderne en matte systeemkleuren chroom, wit en zwart. Niet alleen de modern vormgegeven spots, maar ook de kabels zelf, het toebehoren en de vlakke en lichte trafo's passen perfect bij elkaar door deze uniforme kleurstelling.

DE Passende GU5,3-Leuchtmittel in 3000 K oder 4000 K in den drei Systemfarben

FR Ampoule GU5,3 appropriée de 3 000 K ou 4 000 K en trois couleurs système

NL Geschikte GU5,3-verlichtingsmiddelen in 3000 K of 4000 K in de drie systeemkleuren





☑ = 203



☑ = 196



☞ Chrom matt  
☞ Chrome mate  
☞ Chrom mat

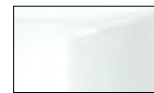

☞ Weiß  
☞ Blanc  
☞ Wit



☞ Schwarz  
☞ Noir  
☞ Zwart



☑ = 191



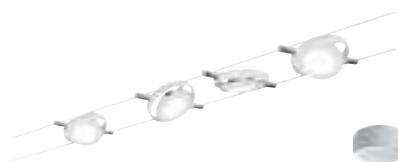
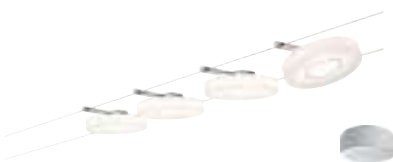
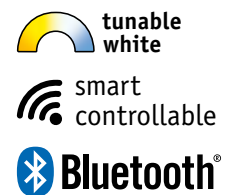
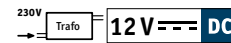

**BLE Set DiscLED I**

incl. 4x4 W  
 4x320 - 440 lm, 2.700 - 6.500 K  
 230/12 V, incl. ⚡ 36 VA  
 ⚡ 160 mm 2,5 mm<sup>2</sup> ↔ 10 m  
 EAN 4000870 501092  
**501.09**

- 🌀 Satin ▣ Metall/Kunststoff
- 🌀 Satiné ▣ Métal/Matière plastique
- 🌀 Satijn ▣ Metaal/Kunststof

**BLE Set RoundMac**

incl. 4x4 W  
 4x320 - 440 lm, 2.700 - 6.500 K  
 230/12 V, incl. ⚡ 36 VA  
 ⚡ 160 mm 2,5 mm<sup>2</sup> ↔ 10 m  
 EAN 4000870 501078  
**501.07**

- 🌀 Weiß matt ▣ Metall/Kunststoff
- 🌀 Blanc dépoli ▣ Métal/Matière plastique
- 🌀 Wit mat ▣ Metaal/Kunststof

**BLE Set IceLED**

incl. 4x4 W  
 4x320 - 440 lm, 2.700 - 6.500 K  
 230/12 V, incl. ⚡ 36 VA  
 ⚡ 160 mm 2,5 mm<sup>2</sup> ↔ 10 m  
 EAN 4000870 500163  
**500.16**

- 🌀 Chrom matt/Weiß ▣ Metall
- 🌀 Chrome mat/Blanc ▣ Métal
- 🌀 Chroom mat/Wit ▣ Metaal



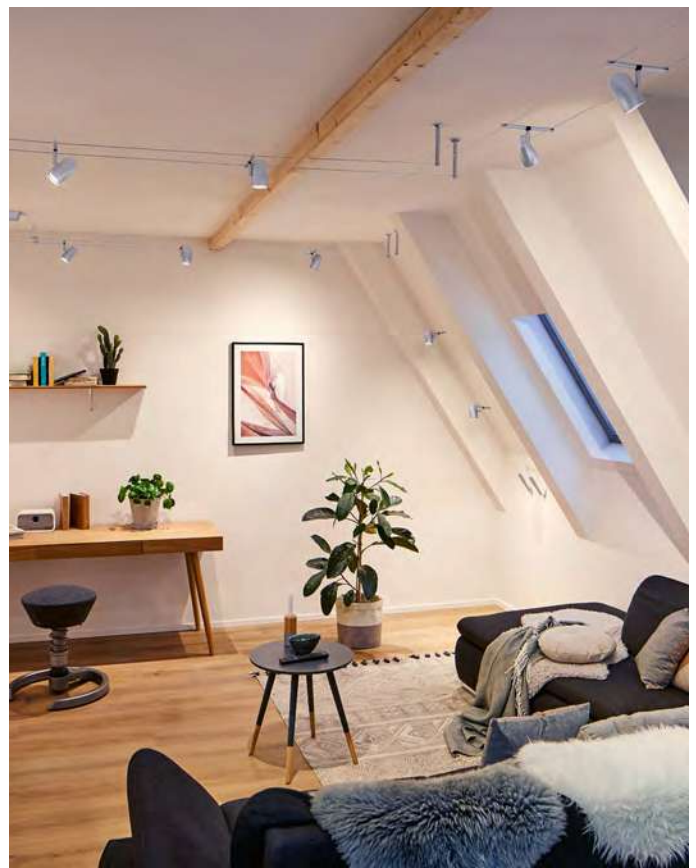

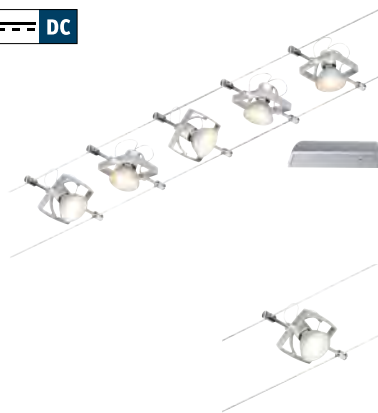
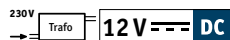
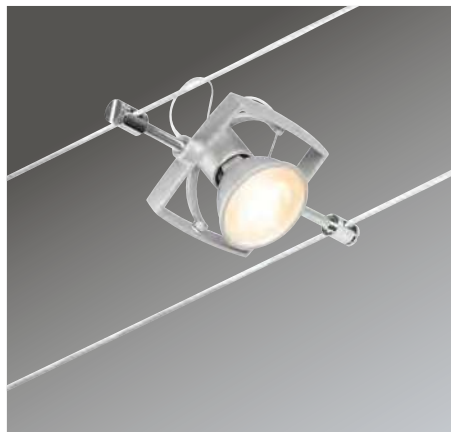

**Set Mac II**

max. 5x10W, GU5,3  
 230/12V, incl. ⚡ 60VA  
 ⚡ 160 mm 2,5 mm<sup>2</sup> ↔ 10 m  
 EAN 4000870 944301  
**944.30 new**



**Spot Mac II**

max. 10W, GU5,3  
 12V  
 ⚡ 160 mm  
 EAN 4000870 944318  
**944.31 new**



- ⌘ Chrom matt Kunststoff
- ⌘ Chrome mat Matière plastique
- ⌘ Chroom mat Kunststof

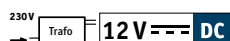

**Set Mac II**

max. 5x10W, GU5,3  
 230/12V, incl. ⚡ 60VA  
 ⚡ 160 mm 2,5 mm<sup>2</sup> ↔ 10 m  
 EAN 4000870 944325  
**944.32 new**



**Spot Mac II**

max. 10W, GU5,3  
 12V  
 ⚡ 160 mm  
 EAN 4000870 944332  
**944.33 new**



- ⌘ Weiß matt/Chrom Kunststoff
- ⌘ Blanc dépoli/Chrome Matière plastique
- ⌘ Wit mat/Chroom Kunststof

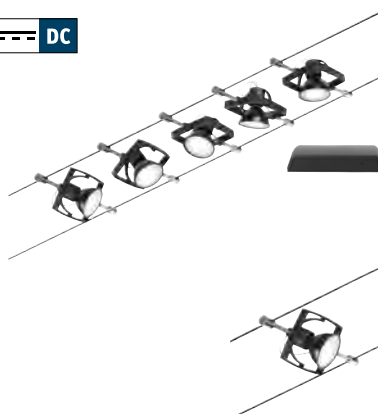
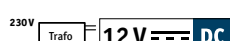
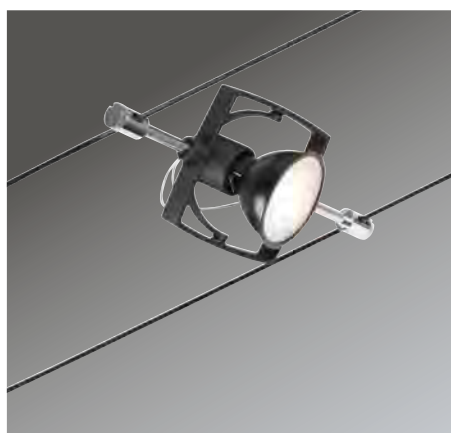

**Set Mac II**

max. 5x10W, GU5,3  
 230/12V, incl. ⚡ 60VA  
 ⚡ 160 mm 2,5 mm<sup>2</sup> ↔ 10 m  
 EAN 4000870 944349  
**944.34 new**



**Spot Mac II**

max. 10W, GU5,3  
 12V  
 ⚡ 160 mm  
 EAN 4000870 944356  
**944.35 new**



- ⌘ Schwarz matt/Chrom Kunststoff
- ⌘ Noir mat/Chrome Matière plastique
- ⌘ Zwart mat/Chroom Kunststof

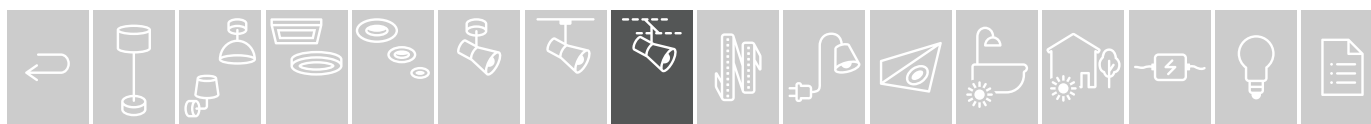

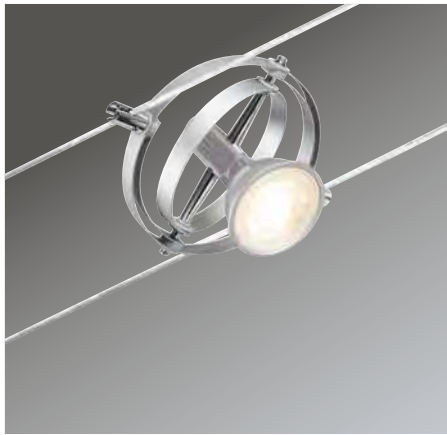

- ↳ Chrom matt Metall
- ↳ Chrome mat Métal
- ↳ Chroom mat Metaal

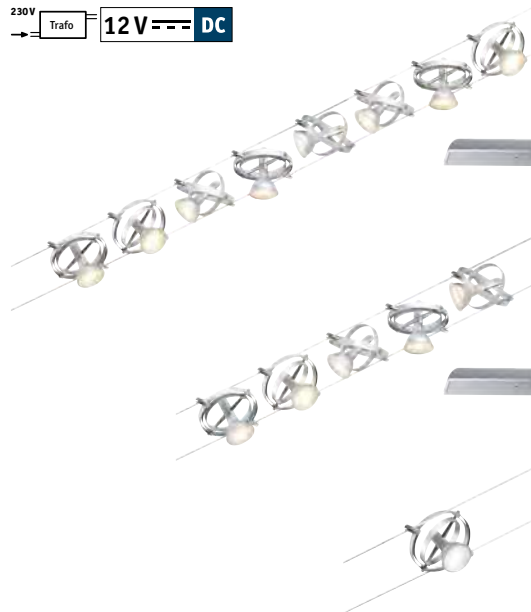
**Set Cardan**

max. 8×7,5 W, GU5,3  
 230/12V, incl. 60 VA  
 125 mm 2,5 mm<sup>2</sup> ⇔ 10 m  
 EAN 4000870 944905  
**944.90 new**

**Set Cardan**

max. 5×10 W, GU5,3  
 230/12V, incl. 60 VA  
 125 mm 2,5 mm<sup>2</sup> ⇔ 10 m  
 EAN 4000870 944363  
**944.36 new**

**SPOT Cardan**

max. 10 W, GU5,3  
 12 V  
 125 mm  
 EAN 4000870 944370  
**944.37 new**

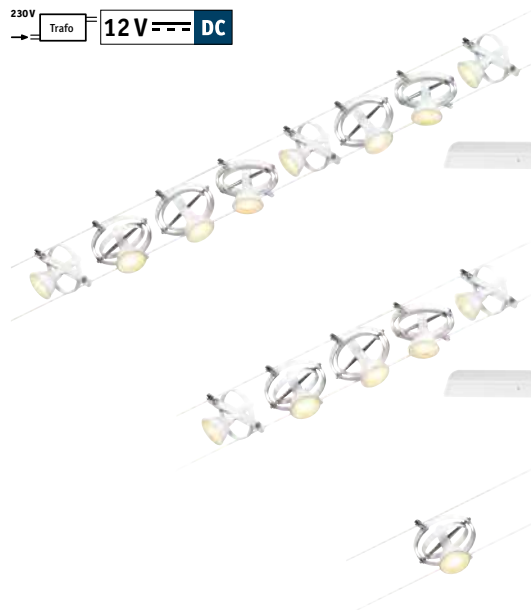

- ↳ Weiß matt Metall
- ↳ Blanc dépoli Métal
- ↳ Wit mat Metaal

**Set Cardan**

max. 8×7,5 W, GU5,3  
 230/12V, incl. 60 VA  
 125 mm 2,5 mm<sup>2</sup> ⇔ 10 m  
 EAN 4000870 944929  
**944.92 new**

**Set Cardan**

max. 5×10 W, GU5,3  
 230/12V, incl. 60 VA  
 125 mm 2,5 mm<sup>2</sup> ⇔ 10 m  
 EAN 4000870 944387  
**944.38 new**

**Spot Cardan**

max. 10 W, GU5,3  
 12 V  
 125 mm  
 EAN 4000870 944394  
**944.39 new**

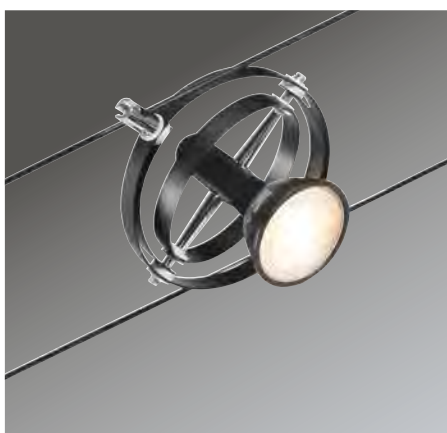

- ↳ Schwarz matt Metall
- ↳ Noir mat Métal
- ↳ Zwart mat Metaal

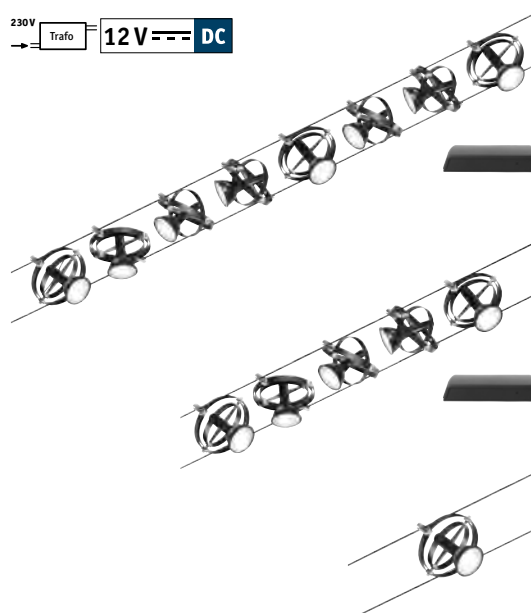
**Set Cardan**

max. 8×7,5 W, GU5,3  
 230/12V, incl. 60 VA  
 125 mm 2,5 mm<sup>2</sup> ⇔ 10 m  
 EAN 4000870 944943  
**944.94 new**

**Set Cardan**

max. 5×10 W, GU5,3  
 230/12V, incl. 60 VA  
 125 mm 2,5 mm<sup>2</sup> ⇔ 10 m  
 EAN 4000870 944400  
**944.40 new**

**Spot Cardan**

max. 10 W, GU5,3  
 12 V  
 125 mm  
 EAN 4000870 944417  
**944.41 new**





- ↳ Chrom matt ▣ Kunststoff
- ↳ Chrome mat ▣ Matière plastique
- ↳ Chroom mat ▣ Kunststof

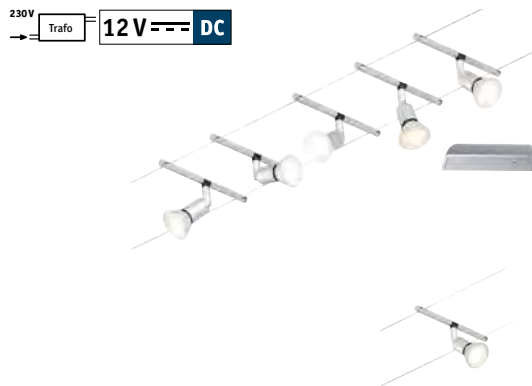

**Set Salt**  
 max. 5×10W, GU5,3  
 230/12V, incl. ⚡ 60VA  
 ⚡ 160 mm 2,5 mm<sup>2</sup> ↔ 10 m  
 EAN 4000870 944424  
**944.42 new**

**Spot Salt**  
 max. 10W, GU5,3  
 12V  
 ⚡ 160 mm  
 EAN 4000870 944431  
**944.43 new**



- ↳ Weiß matt/Chrom ▣ Kunststoff
- ↳ Blanc dépoli/Chrome ▣ Matière plastique
- ↳ Wit mat/Chroom ▣ Kunststof

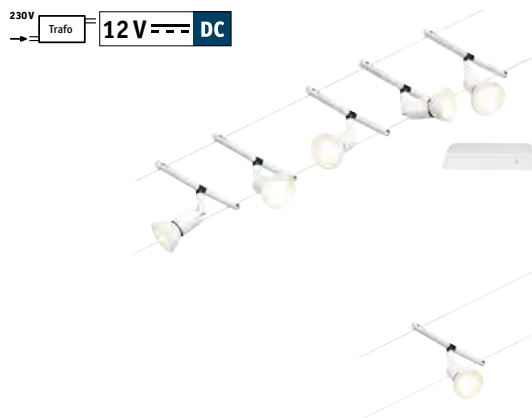

**Set Salt**  
 max. 5×10W, GU5,3  
 230/12V, incl. ⚡ 60VA  
 ⚡ 160 mm 2,5 mm<sup>2</sup> ↔ 10 m  
 EAN 4000870 944585  
**944.58 new**

**Spot Salt**  
 max. 10W, GU5,3  
 12V  
 ⚡ 160 mm  
 EAN 4000870 944455  
**944.45 new**



- ↳ Schwarz ▣ Kunststoff
- ↳ Noir ▣ Matière plastique
- ↳ Zwart ▣ Kunststof

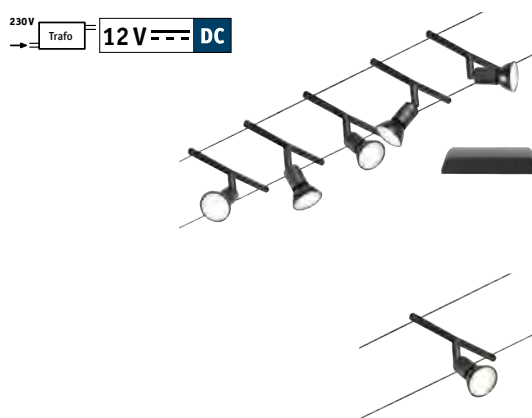

**Set Salt**  
 max. 5×10W, GU5,3  
 230/12V, incl. ⚡ 60VA  
 ⚡ 160 mm 2,5 mm<sup>2</sup> ↔ 10 m  
 EAN 4000870 944462  
**944.46 new**

**Spot Salt**  
 max. 10W, GU5,3  
 12V  
 ⚡ 160 mm  
 EAN 4000870 944479  
**944.47 new**





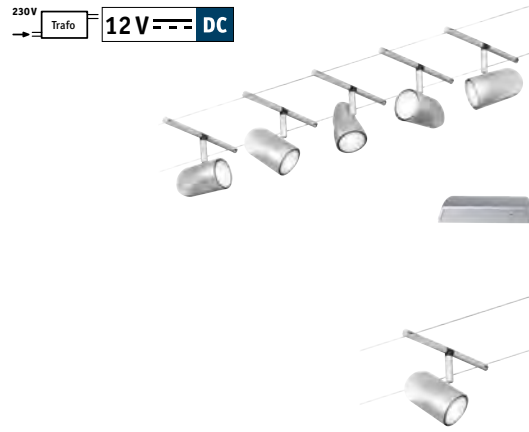

⌘ Chrom matt/Chrom ⌘ Kunststoff/Metall  
 ⌘ Chrome mat/Chrome ⌘ Matière plastique/  
 Métal ⌘ Chroom mat/Chroom ⌘ Kunststof/  
 Metaal

**Set Cup**

max. 5×10W, GU5,3  
 230/12V, incl. ⚡ 60VA  
 ⚡ 160 mm ⚡ 124 mm ⚡ 58 mm  
 2,5 mm<sup>2</sup> ⚡ 100 mm ⚡ 58 mm  
 ⚡ 10 m  
 EAN 4000870 944653  
**944.65 new**

**Spot Cup**

max. 10W, GU5,3  
 12V  
 ⚡ 160 ⚡ 124 ⚡ 58 ⚡ 100  
 ⚡ 58 mm  
 EAN 4000870 944660  
**944.66 new**

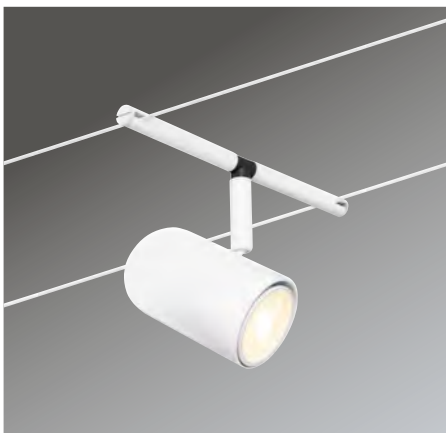

⌘ Weiß matt/Chrom ⌘ Kunststoff/Metall  
 ⌘ Blanc dépoli/Chrome ⌘ Matière plastique/  
 Métal ⌘ Wit mat/Chroom ⌘ Kunststof/  
 Metaal

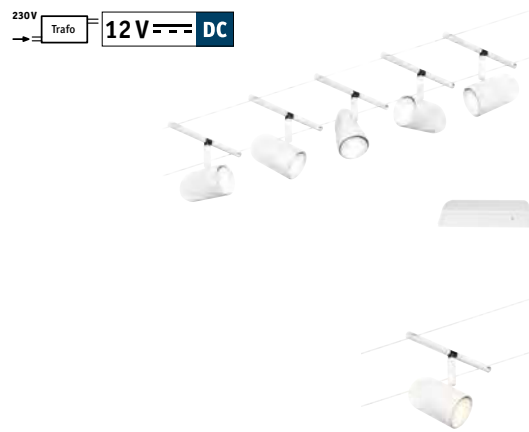
**Set Cup**

max. 5×10W, GU5,3  
 230/12V, incl. ⚡ 60VA  
 ⚡ 160 mm ⚡ 124 mm ⚡ 58 mm  
 2,5 mm<sup>2</sup> ⚡ 100 mm ⚡ 58 mm  
 ⚡ 10 m  
 EAN 4000870 944677  
**944.67 new**

**Spot Cup**

max. 10W, GU5,3  
 12V  
 ⚡ 160 ⚡ 124 ⚡ 58 ⚡ 100  
 ⚡ 58 mm  
 EAN 4000870 944684  
**944.68 new**

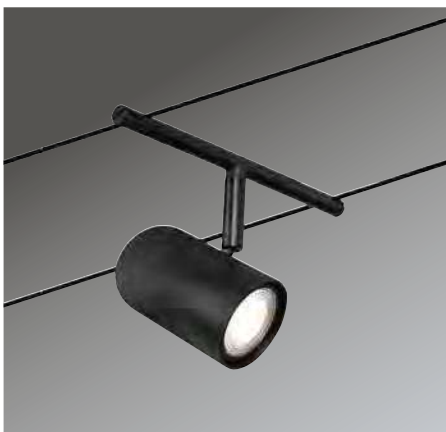

⌘ Schwarz matt/Chrom ⌘ Kunststoff/Metall  
 ⌘ Noir mat/Chrome ⌘ Matière plastique/  
 Métal ⌘ Zwart mat/Chroom ⌘ Kunststof/  
 Metaal

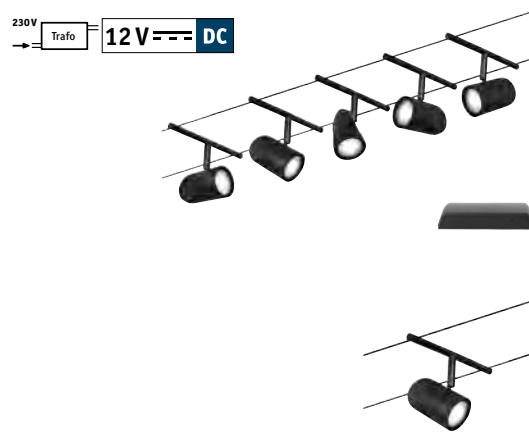
**Set Cup**

max. 5×10W, GU5,3  
 230/12V, incl. ⚡ 60VA  
 ⚡ 160 mm ⚡ 124 mm ⚡ 58 mm  
 2,5 mm<sup>2</sup> ⚡ 100 mm ⚡ 58 mm  
 ⚡ 10 m  
 EAN 4000870 944691  
**944.69 new**

**Spot Cup**

max. 10W, GU5,3  
 12V  
 ⚡ 160 ⚡ 124 ⚡ 58 ⚡ 100  
 ⚡ 58 mm  
 EAN 4000870 944707  
**944.70 new**





230V → Trafo = 12V --- DC



Perfect match  
283.30

### Set Sheela

max. 5x10W, GU5,3  
230/12V, incl. ⚡ 60VA  
± 160 mm 2,5 mm<sup>2</sup> ↔ 10 m  
EAN 4000870 944486  
**944.48 new**



### Spot Sheela

max. 10W, GU5,3  
± 160 mm  
EAN 4000870 944493  
**944.49 new**



- ⌘ Chrom matt ▣ Kunststoff
- ⌘ Chrome mat ▣ Matière plastique
- ⌘ Chroom mat ▣ Kunststof



230V → Trafo = 12V --- DC

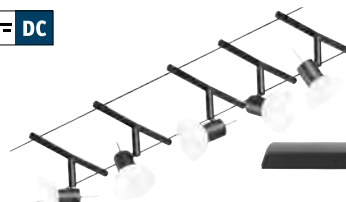

Perfect match  
283.30

### Set Sheela

max. 5x10W, GU5,3  
230/12V, incl. ⚡ 60VA  
± 160 mm 2,5 mm<sup>2</sup> ↔ 10 m  
EAN 4000870 944509  
**944.50 new**



### Spot Sheela

max. 10W, GU5,3  
± 160 mm  
EAN 4000870 944516  
**944.51 new**



- ⌘ Schwarz matt/Chrom ▣ Kunststoff
- ⌘ Noir mat/Chrome ▣ Matière plastique
- ⌘ Zwart mat/Chroom ▣ Kunststof

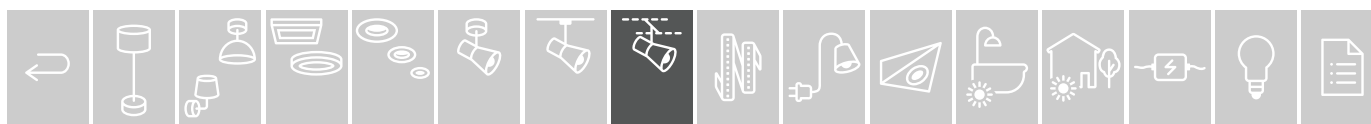



230V → Trafo = 12V --- DC



#### Set Cone

max. 5×10W, GU5,3  
230/12V, incl. ⚡ 60VA  
±160 mm ↑145 mm ∅84 mm  
2,5 mm<sup>2</sup> ↔94 mm ↗84 mm ↔10 m  
EAN 4000870 944592  
**944.59 new**

#### Spot Cone

max. 10W, GU5,3  
12V  
±160 ↑145 ∅84 ↔94 ↗84 mm  
EAN 4000870 944608  
**944.60 new**

⌘ Chrom matt/Chrom ▣ Kunststoff/Metall  
⌘ Chrome mat/Chrome ▣ Matière plastique/Métal  
⌘ Chroom mat/Chroom ▣ Kunststof/Metaal



230V → Trafo = 12V --- DC



#### Set Cone

max. 5×10W, GU5,3  
230/12V, incl. ⚡ 60VA  
±160 mm ↑145 mm ∅84 mm  
2×2,5 mm<sup>2</sup> ↔94 mm ↗84 mm  
↔10 m  
EAN 4000870 944615  
**944.61 new**

#### Spot Cone

max. 10W, GU5,3  
12V  
±160 ↑145 ∅84 ↔94 ↗84 mm  
EAN 4000870 944622  
**944.62 new**

⌘ Weiß matt/Chrom ▣ Kunststoff/Metall  
⌘ Blanc dépoli/Chrome ▣ Matière plastique/Métal  
⌘ Wit mat/Chroom ▣ Kunststof/Metaal



230V → Trafo = 12V --- DC



#### Set Cone

max. 5×10W, GU5,3  
230/12V, incl. ⚡ 60VA  
±160 mm ↑145 mm ∅84 mm  
2,5 mm<sup>2</sup> ↔94 mm ↗84 mm ↔10 m  
EAN 4000870 944639  
**944.63 new**

#### Spot Cone

max. 10W, GU5,3  
12V  
±160 ↑145 ∅84 ↔94 ↗84 mm  
EAN 4000870 944646  
**944.64 new**

⌘ Schwarz matt/Chrom ▣ Kunststoff/Metall  
⌘ Noir mat/Chrome ▣ Matière plastique/Métal  
⌘ Zwart mat/Chroom ▣ Kunststof/Metaal



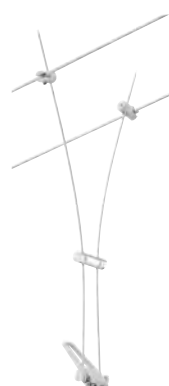

**Spot Comet**

max. 50 W, GU5,3  
12 V  
∅310 ∅28 ∅10 mm  
EAN 4000870 944875

**944.87 new**

- ☞ Chrom □ Metall
- ☞ Chrome □ Métal
- ☞ Chrom □ Metaal



**Spot Comet**

max. 50 W, GU5,3  
12 V  
∅310 ∅28 ∅10 mm  
EAN 4000870 944882

**944.88 new**

- ☞ Weiß □ Metall
- ☞ Blanc □ Métal
- ☞ Wit □ Metaal



**Spot Comet**

max. 50 W, GU5,3  
12 V  
∅310 ∅28 ∅10 mm  
EAN 4000870 944899

**944.89 new**

- ☞ Schwarz □ Metall
- ☞ Noir □ Métal
- ☞ Zwart □ Metaal





⌘ Chrom matt/Chrom 

Metall
--------

  
 ⌘ Chrome mat/Chrome 

Métal
-------

  
 ⌘ Chroom mat/Chroom 

Metaal
--------

230V → Trafo = 12V 

DC
----

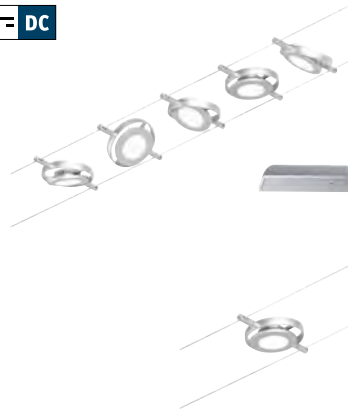

#### Set Round Mac

incl. 5×4,5W 

□
---

  
 5×450 lm, 3.000 K  
 230/12V, incl. 

⚡
---

 60 VA  

⚡
---

 160 mm 2,5 mm<sup>2</sup> ↔10 m  
 EAN 4000870 944141  
**944.14 new**

#### Spot Round Mac

incl. 1×4,5W 

◊
---

  
 450 lm, 3.000 K  
 12 V  

⚡
---

 160 

↕
---

 24 

⊙
---

 102 mm  
 EAN 4000870 944158  
**944.15 new**



⌘ Weiß/Chrom 

Metall
--------

  
 ⌘ Blanc/Chrome 

Métal
-------

  
 ⌘ Wit/Chroom 

Metaal
--------

230V → Trafo = 12V 

DC
----



#### Set Round Mac

incl. 5×4,5W 

□
---

  
 5×450 lm, 3.000 K  
 230/12V, incl. 

⚡
---

 60 VA  

⚡
---

 160 mm 2,5 mm<sup>2</sup> ↔10 m  
 EAN 4000870 944165  
**944.16 new**

#### Spot Round Mac

incl. 1×4,5W 

◊
---

  
 450 lm, 3.000 K  
 12 V  

⚡
---

 160 

↕
---

 24 

⊙
---

 102 mm  
 EAN 4000870 944172  
**944.17 new**



⌘ Schwarz matt/Chrom 

Metall
--------

  
 ⌘ Noir mat/Chrome 

Métal
-------

  
 ⌘ Zwart mat/Chroom 

Metaal
--------

230V → Trafo = 12V 

DC
----

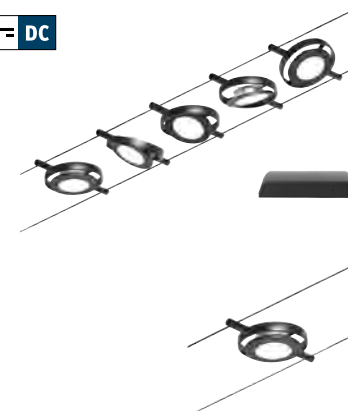

#### Set Round Mac

incl. 5×4,5W 

□
---

  
 5×450 lm, 3.000 K  
 230/12V, incl. 

⚡
---

 60 VA  

⚡
---

 160 mm 2,5 mm<sup>2</sup> ↔10 m  
 EAN 4000870 944189  
**944.18 new**

#### Spot Round Mac

incl. 1×4,5W 

◊
---

  
 450 lm, 3.000 K  
 12 V  

⚡
---

 160 

↕
---

 24 

⊙
---

 102 mm  
 EAN 4000870 944196  
**944.19 new**



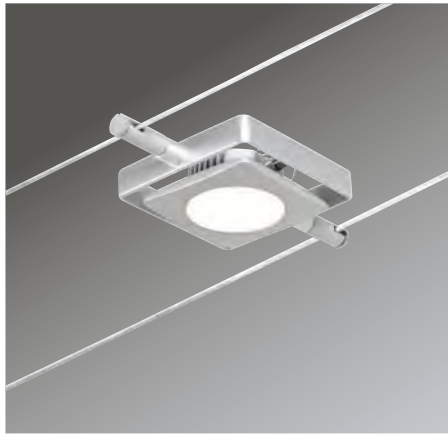

- 🌀 Chrom matt/Chrom 📦 Metall
- 🌀 Chrome mat/Chrome 📦 Métal
- 🌀 Chroom mat/Chroom 📦 Metaal

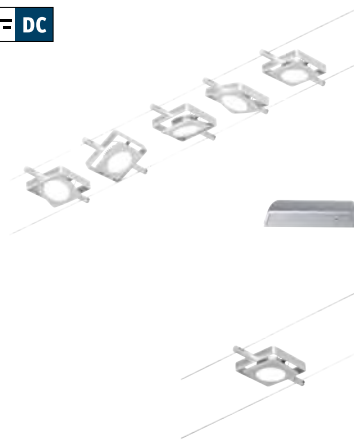
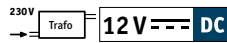

**Set MacLED**

incl. 5×4,5W  
 5×450 lm, 3.000 K  
 230/12V, incl. ⚡ 60 VA  
 ⚡ 160 mm ⚡ 24 mm 2,5 mm<sup>2</sup>  
 ⇄92 mm ⇄92 mm ⇄10 m  
 EAN 4000870 944202  
**944.20 new**

**Spot MacLED**

incl. 1×4,5W  
 450 lm, 3.000 K  
 12 V  
 ⚡ 160 mm ⚡ 24 mm 2,5 mm<sup>2</sup>  
 ⇄92 mm ⇄92 mm ⇄10 m  
 EAN 4000870 944219  
**944.21 new**

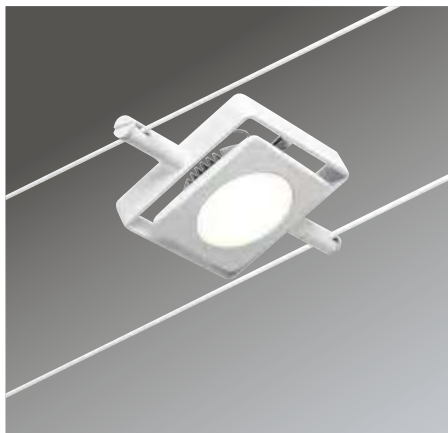

- 🌀 Weiß/Chrom 📦 Metall
- 🌀 Blanc/Chrome 📦 Métal
- 🌀 Wit/Chroom 📦 Metaal

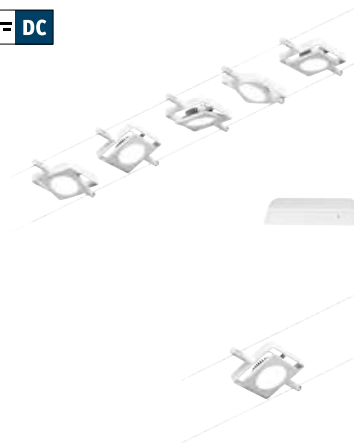
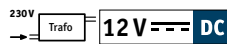

**Set MacLED**

incl. 5×4,5W  
 5×450 lm, 3.000 K  
 230/12V, incl. ⚡ 60 VA  
 ⚡ 160 mm ⚡ 24 mm 2,5 mm<sup>2</sup>  
 ⇄92 mm ⇄92 mm ⇄10 m  
 EAN 4000870 944226  
**944.22 new**

**Spot MacLED**

incl. 1×4,5W  
 450 lm, 3.000 K  
 12 V  
 ⚡ 160 mm ⚡ 24 mm 2,5 mm<sup>2</sup>  
 ⇄92 mm ⇄92 mm ⇄10 m  
 EAN 4000870 944233  
**944.23 new**

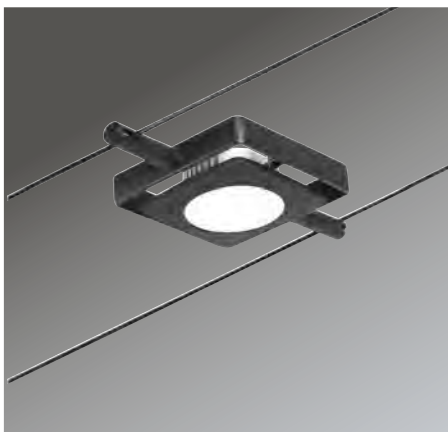

- 🌀 Schwarz matt/Chrom 📦 Metall
- 🌀 Noir mat/Chrome 📦 Métal
- 🌀 Zwart mat/Chroom 📦 Metaal

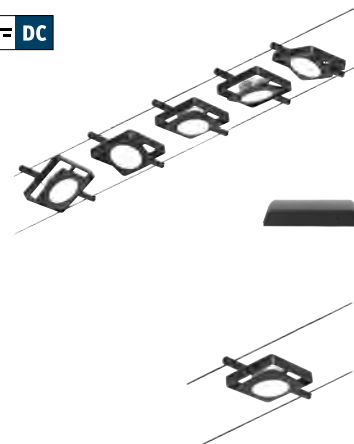
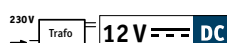

**Set MacLED**

incl. 5×4,5W  
 5×450 lm, 3.000 K  
 230/12V, incl. ⚡ 60 VA  
 ⚡ 160 mm ⚡ 24 mm 2,5 mm<sup>2</sup>  
 ⇄92 mm ⇄92 mm ⇄10 m  
 EAN 4000870 944240  
**944.24 new**

**Spot MacLED**

incl. 1×4,5W  
 450 lm, 3.000 K  
 12 V  
 ⚡ 160 mm ⚡ 24 mm 2,5 mm<sup>2</sup>  
 ⇄92 mm ⇄92 mm ⇄10 m  
 EAN 4000870 944257  
**944.25 new**





230V → Trafo = 12V --- DC



#### Set DiscLED

incl. 5×4,5W  
5×450lm, 3.000K  
230/12V, incl. ⚡ 60VA  
⊕ ⊖ 160mm ⊕ 38mm ∅130mm  
2,5mm<sup>2</sup> ↔ 10m  
EAN 4000870 944264  
**944.26 new**

#### Spot DiscLED

incl. 1×4,5W  
450lm, 3.000K  
12V  
⊕ ⊖ 160 ⊕ 38 ∅130mm  
EAN 4000870 944271  
**944.27 new**

- 🌀 Satin ☐ Metall/Kunststoff
- 🌀 Satiné ☐ Métal/Matière plastique
- 🌀 Satijn ☐ Metaal/Kunststof







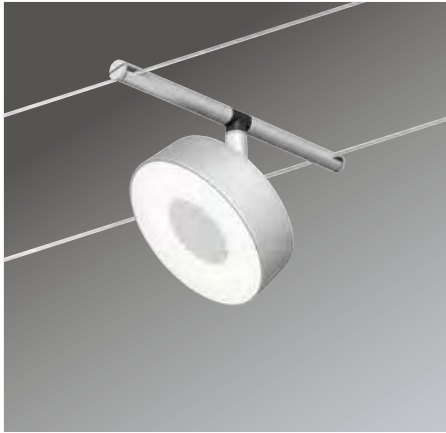

⌘ Chrom matt/Chrom ⌘ Kunststoff/Metall  
 ⌘ Chrome mat/Chrome ⌘ Matière plastique/  
 Métal ⌘ Chroom mat/Chroom ⌘ Kunststof/  
 Metaal

230V → Trafo = 12V --- DC



#### Set Circle

incl. 5×5 W   
 5×400 lm, 3.000 K  
 230/12V, incl. ⚡ 60 VA  
 ⚡ 160 mm ⚡ 96 mm ⚡ 99 mm  
 2,5 mm<sup>2</sup> ⇔ 5 m  
 EAN 4000870 944752  
**944.75 new**

#### Spot Circle

incl. 1×5 W   
 400 lm, 3.000 K  
 12 V  
 ⚡ 160 ⚡ 96 ⚡ 99 mm  
 EAN 4000870 944769  
**944.76 new**



⌘ Weiß matt/Chrom ⌘ Kunststoff/Metall  
 ⌘ Blanc dépoli/Chrome ⌘ Matière plastique/  
 Métal ⌘ Wit mat/Chroom ⌘ Kunststof/  
 Metaal

230V → Trafo = 12V --- DC



#### Set Circle

incl. 5×5 W   
 5×400 lm, 3.000 K  
 230/12V, incl. ⚡ 60 VA  
 ⚡ 160 mm ⚡ 96 mm ⚡ 99 mm  
 2,5 mm<sup>2</sup> ⇔ 5 m  
 EAN 4000870 944776  
**944.77 new**

#### Spot Circle

incl. 1×5 W   
 400 lm, 3.000 K  
 12 V  
 ⚡ 160 ⚡ 96 ⚡ 99 mm  
 EAN 4000870 944783  
**944.78 new**



⌘ Schwarz matt/Chrom ⌘ Kunststoff/Metall  
 ⌘ Noir mat/Chrome ⌘ Matière plastique/  
 Métal ⌘ Zwart mat/Chroom ⌘ Kunststof/  
 Metaal

230V → Trafo = 12V --- DC



#### Set Circle

incl. 5×5 W   
 5×400 lm, 3.000 K  
 230/12V, incl. ⚡ 60 VA  
 ⚡ 160 mm ⚡ 96 mm ⚡ 99 mm  
 2,5 mm<sup>2</sup> ⇔ 5 m  
 EAN 4000870 944790  
**944.79 new**

#### Spot Circle

incl. 1×5 W   
 400 lm, 3.000 K  
 12 V  
 ⚡ 160 ⚡ 96 ⚡ 99 mm  
 EAN 4000870 944806  
**944.80 new**



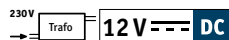
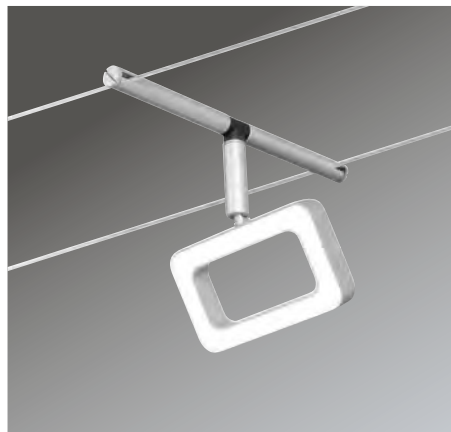

**Set Frame**

incl. 5×4,8W  
5×400lm, 3.000K  
230/12V, incl. ⚡ 60VA  
⊕160mm ⊕130mm 2,5mm²  
↔104mm ↗16mm ↔5m  
EAN 4000870 944813  
**944.81 new**

**Spot Frame**

incl. 1×4,8W  
400lm, 3.000K  
12V  
⊕160 ⊕130 ↔104 ↗16mm  
EAN 4000870 944820  
**944.82 new**

⌘ Chrom matt/Chrom ▣ Kunststoff/Metall  
⌘ Chrome mat/Chrome ▣ Matière plastique/Métal  
⌘ Chroom mat/Chroom ▣ Kunststof/Metaal

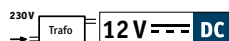
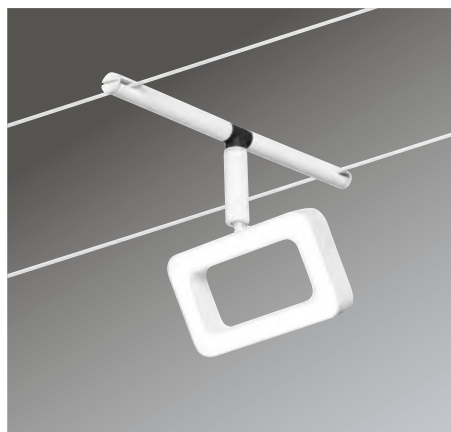

**Set Frame**

incl. 5×4,8W  
5×400lm, 3.000K  
230/12V, incl. ⚡ 60VA  
⊕160mm ⊕130mm 2,5mm²  
↔104mm ↗16mm ↔5m  
EAN 4000870 944837  
**944.83 new**

**Spot Frame**

incl. 1×4,8W  
400lm, 3.000K  
12V  
⊕160 ⊕130 ↔104 ↗16mm  
EAN 4000870 944844  
**944.84 new**

⌘ Weiß matt/Chrom ▣ Kunststoff/Metall  
⌘ Blanc dépoli/Chrome ▣ Matière plastique/Métal  
⌘ Wit mat/Chroom ▣ Kunststof/Metaal

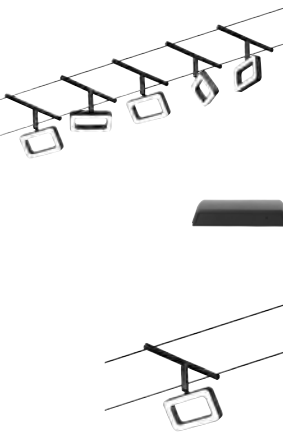
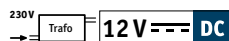
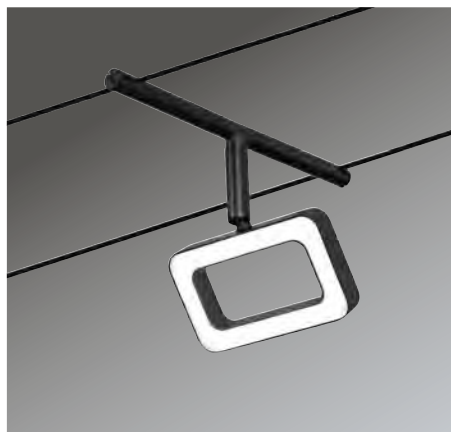

**Set Frame**

incl. 5×4,8W  
5×400lm, 3.000K  
230/12V, incl. ⚡ 60VA  
⊕160mm ⊕130mm 2,5mm²  
↔104mm ↗16mm ↔5m  
EAN 4000870 944851  
**944.85 new**

**Spot Frame**







incl. 1×4,8W  
400lm, 3.000K  
12V  
⊕160 ⊕130 ↔104 ↗16mm  
EAN 4000870 944868  
**944.86 new**

⌘ Schwarz matt/Chrom ▣ Kunststoff/Metall  
⌘ Noir mat/Chrome ▣ Matière plastique/Métal  
⌘ Zwart mat/Chroom ▣ Kunststof/Metaal









230V  Trafo **12V DC**









 Chrom matt  Kunststoff  
 Chrome mat  Matière plastique  
 Chroom mat  Kunststof





 Weiß matt  Kunststoff  
 Blanc dépoli  Matière plastique  
 Wit mat  Kunststof

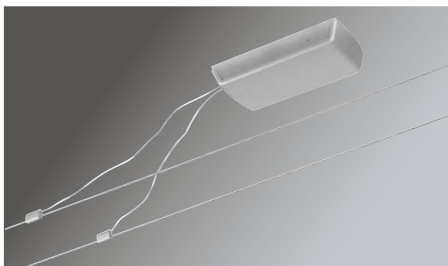

 Schwarz matt  Kunststoff  
 Noir mat  Matière plastique  
 Zwart mat  Kunststof



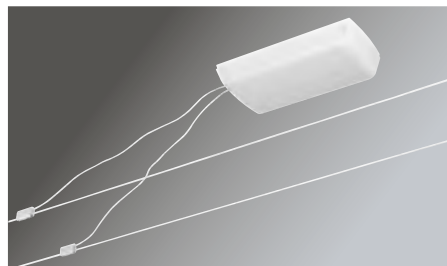

#### Basic Set Corduo

max. 60 W   
 230/12 V, incl.  60 VA  
 ⌀47 mm 2,5 mm<sup>2</sup> ⇔115 mm ↗240 mm ⇔12 m  
 EAN 4000870 944288  
**944.28 new**



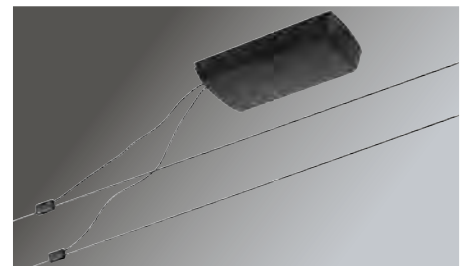

#### Basic Set Corduo

max. 60 W   
 230/12 V, incl.  60 VA  
 ⌀47 mm 2,5 mm<sup>2</sup> ⇔115 mm ↗240 mm ⇔12 m  
 EAN 4000870 944295  
**944.29 new**





#### Basic Set Corduo

max. 60 W   
 230/12 V, incl.  60 VA  
 ⌀47 mm 2,5 mm<sup>2</sup> ⇔115 mm ↗240 mm ⇔12 m  
 EAN 4000870 944967  
**944.96 new**





#### Driver Corduo

max. 60 W   
 230/12 V, incl.  60 VA  
 ⌀47 ⇔240 ↗115 mm  
 EAN 4000870 978382  
**978.38 new**





#### Driver Corduo

max. 60 W   
 230/12 V, incl.  60 VA  
 ⌀47 ⇔240 ↗115 mm  
 EAN 4000870 978399  
**978.39 new**



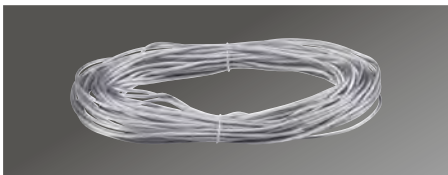

#### Driver Corduo

max. 60 W   
 230/12 V, incl.  60 VA  
 ⌀47 ⇔240 ↗115 mm  
 EAN 4000870 978405  
**978.40 new**



#### Corduo

2,5 mm<sup>2</sup> ⇔20 m  
 EAN 4000870 945896  
**945.89 new**

 Transparent  
 Transparent  
 Transparant



#### Corduo

2,5 mm<sup>2</sup> ⇔20 m  
 EAN 4000870 945919  
**945.91 new**

 Weiß  
 Blanc  
 Wit



#### Corduo

2,5 mm<sup>2</sup> ⇔20 m  
 EAN 4000870 945933  
**945.93 new**

 Schwarz  
 Noir  
 Zwart



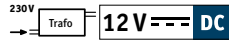

**Set TunLED**

incl. 5x4 W  
 5x360 lm, 2.700 K  
 230/12V, incl.  $\text{☑}$  30 VA  
 $\text{⊕}$  160 mm 1,5 mm<sup>2</sup>  $\leftrightarrow$  10 m  
 EAN 4000870 039809  
**3980**

- 🌀 Weiß/Chrom matt  $\text{⊞}$  Kunststoff
- 🌀 Blanc/Chrome mat  $\text{⊞}$  Matière plastique
- 🌀 Wit/Chroom mat  $\text{⊞}$  Kunststof

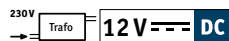

**Set TubeLED**

incl. 5x4 W  
 5x360 lm, 2.700 K  
 230/12V, incl.  $\text{☑}$  30 VA  
 $\text{⊕}$  160 mm 2,5 mm<sup>2</sup>  $\leftrightarrow$  10 m  
 EAN 4000870 039816  
**3981**

- 🌀 Weiß/Schwarz/Chrom  $\text{⊞}$  Kunststoff
- 🌀 Blanc/Noir/Chrome  $\text{⊞}$  Matière plastique
- 🌀 Wit/Zwart/Chroom  $\text{⊞}$  Kunststof





230V → Trafo = 12V --- DC



#### Set Clear

incl. 5×4 W  
 5×300 lm, 2.700 K  
 230/12V, incl. ⚡ 30 VA  
 ⚙️ 160 mm 2,5 mm<sup>2</sup> ↔ 10 m  
 EAN 4000870 944578  
**944.57 new**

- 🌀 Schwarz/Chrom 🗪 Kunststoff
- 🌀 Noir/Chrome 🗪 Matière plastique
- 🌀 Zwart/Chroom 🗪 Kunststof





230V **12V** **AC**



**Set Stage**

incl. 4x5W  
4x400 lm, 2.700 K  
230/12V, incl. 30 VA  
⌀ 160 mm 2,5 mm<sup>2</sup> ⇔ 10 m  
EAN 4000870 940808  
**940.80**

- Weiß/Chrom Metall/Glas
- Blanc/Chrome Métal/Verre
- Wit/Chroom Metaal/Glas



230V **12V** **AC**

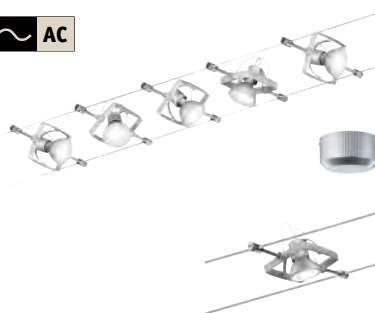

**Set Mac II**

max. 5x10 W, GU5,3  
230/12V, incl. 60 VA  
⌀ 160 mm 2,5 mm<sup>2</sup> ⇔ 10 m  
EAN 4000870 941331  
**941.33**

**Spot Mac II**

max. 10 W, GU5,3  
12V  
⌀ 55 ⇔ 70 ⌀ 70 mm  
EAN 4000870 941324  
**941.32**



- Chrom matt Metall/Kunststoff
- Chrome mat Métal/Matière plastique
- Chroom mat Metaal/Kunststof





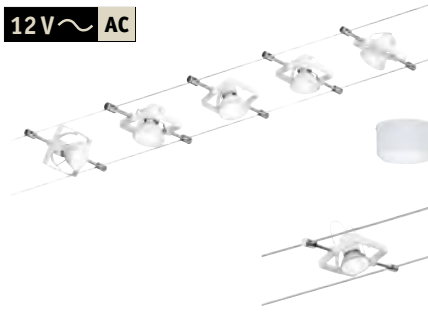





230V  **12V**  **AC**

**Set Mac II**

max. 5×10 W, GU5,3   
 230/12 V, incl.  60 VA  
 ⌀ 160 mm 2,5 mm<sup>2</sup> ⇔ 10 m  
 EAN 4000870 941348  
**941.34**

**Spot Mac II**



max. 10 W, GU5,3   
 12 V  
 ⌀ 160 ⇔ 70 mm  
 EAN 4000870 941485  
**941.48**

 Weiß matt/Chrom  Kunststoff  
 Blanc dépoli/Chrome  Matière plastique  
 Wit mat/Chroom  Kunststof



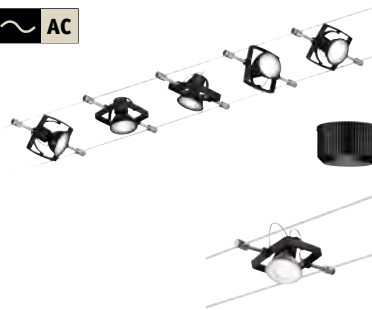





230V  **12V**  **AC**

**Set Mac II**

max. 5×10 W, GU5,3   
 230/12 V, incl.  60 VA  
 ⌀ 160 mm 2,5 mm<sup>2</sup> ⇔ 10 m  
 EAN 4000870 942901  
**942.90**

**Spot Mac II**

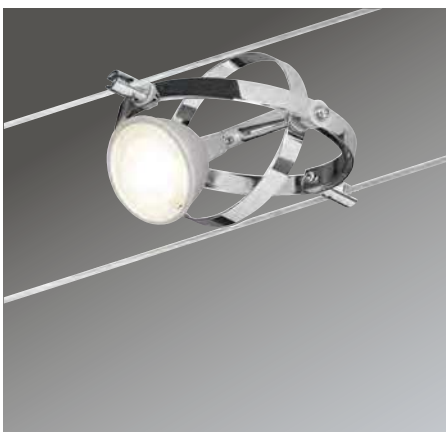

max. 10 W, GU5,3   
 12 V  
 ⌀ 55 ⇔ 70 ⇔ 70 mm  
 EAN 4000870 942918  
**942.91**

 Schwarz matt  Metall/Kunststoff  
 Noir mat  Métal/Matière plastique  
 Zwart mat  Metaal/Kunststof











230V  **12V**  **AC**

**Set Cardan**

max. 8×10 W, GU5,3   
 230/12 V, incl.  80 VA  
 ⌀ 125 mm 2,5 mm<sup>2</sup> ⇔ 10 m  
 EAN 4000870 941539  
**941.53**

**Set Cardan**

max. 4×10 W, GU5,3   
 230/12 V, incl.  60 VA  
 ⌀ 125 mm 2,5 mm<sup>2</sup> ⇔ 10 m  
 EAN 4000870 941447  
**941.44**

 Chrom matt/Chrom  Metall  
 Chrome mat/Chrome  Métal  
 Chroom mat/Chroom  Metaal





230V **12V ~ AC**

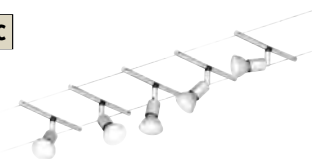

**Set Spice Salt**

max. 5×10W, GU5,3   
 230/12V, incl. 60VA  
 ⚙️ 160 mm ⚙️ 65 mm ⚙️ 28 mm  
 2,5 mm² ⇄ 185 mm ↻ 55 mm  
 ⇄ 10 m  
 EAN 4000870 941454  
**941.45**

- 🌀 Chrom matt Metall
- 🌀 Chrome mat Métal
- 🌀 Chroom mat Metaal



230V **12V ~ AC**



**Set Sheela**

max. 5×10W, GU5,3   
 230/12V, incl. 60VA  
 ⚙️ 160 mm 2,5 mm² ⇄ 10 m  
 EAN 4000870 941362  
**941.36**

- 🌀 Chrom matt/Opal Metall/Glas
- 🌀 Chrome mat/Opale Métal/Verre
- 🌀 Chroom mat/Opaal Metaal/Glas







⌘ Chrom/Satin ⌘ Metall/Glas  
 ⌘ Chrome/Satiné ⌘ Métal/Verre  
 ⌘ Chroom/Satijn ⌘ Metaal/Glas



Perfect match

283.29



### Spot Colmar

max. 10 W, GU4

12 V

⊕⊖ 160 ⊕⊖ 30 ⊕⊖ 110 ø85

⊕⊖ 80 mm

EAN 4000870 941386

**941.38**



⌘ Chrom ⌘ Metall  
 ⌘ Chrome ⌘ Métal  
 ⌘ Chroom ⌘ Metaal

230 V  12 V  AC



### Set Togo

max. 4×10 W, GU5,3

230/12 V, incl.  60 VA

⊕⊖ 160 mm 2,5 mm<sup>2</sup> ↔ 10 m

EAN 4000870 941461

**941.46**



### Spot Togo

max. 10 W, GU5,3

12 V

⊕⊖ 160 ⊕⊖ 80 ø51 mm

EAN 4000870 941478

**941.47**



⌘ Chrom ⌘ Metall  
 ⌘ Chrome ⌘ Métal  
 ⌘ Chroom ⌘ Metaal



### Spot Comet

max. 50 W, GU5,3

12 V

⊕⊖ 300 ⊕⊖ 300 mm

EAN 4000870 971130

**971.1229** 





*Kombinieren Sie selbst Ihr persönliches Lichtsystem  
Composez vous-même votre système d'éclairage personnel  
Combineer uw persoonlijk lichtstelsel zelf*

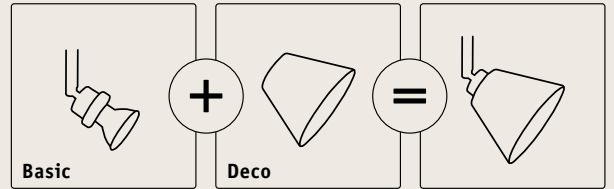

**Spot Basic**  
max. 10 W, GU5,3  
12 V  
160 30  
130 95 75 mm  
EAN 4000870 941416  
**941.41**

Perfect match  
283.30

- 🔗 Chrom matt  Metall
- 🔗 Chrome mat  Métal
- 🔗 Chroom mat  Metaal



**Wolbi**

max. 50 W  
 ⚡ 80 ø90 mm  
 EAN 4000870 600115

**600.11**

- 👉 Dichroic 🗍 Glas
- 👉 Dichroïque 🗍 Verre
- 👉 Dichroisch 🗍 Glas

**Vico**

max. 50 W  
 ⚡ 95 ø80 mm  
 EAN 4000870 953570

**953.57**

- 👉 Klar 🗍 Glas
- 👉 Clair 🗍 Verre
- 👉 Helder 🗍 Glas

**Twice**

max. 50 W  
 ⚡ 70 ø100 mm  
 EAN 4000870 701744

**701.74**

- 👉 Klar/Opak 🗍 Glas
- 👉 Clair/Opaque 🗍 Verre
- 👉 Helder/Opaak 🗍 Glas

**Vento**

max. 50 W  
 ⚡ 95 ø80 mm  
 EAN 4000870 953594

**953.59**

- 👉 Rauchglas 🗍 Glas
- 👉 Verre fumé 🗍 Verre
- 👉 Rookglas 🗍 Glas

**Vento**

max. 50 W  
 ⚡ 95 ø80 mm  
 EAN 4000870 953587

**953.58**

- 👉 Satin 🗍 Glas
- 👉 Satiné 🗍 Verre
- 👉 Satijn 🗍 Glas

**Wolbi**

max. 50 W  
 ⚡ 70 ø90 mm  
 EAN 4000870 600559

**600.55**

- 👉 Opal 🗍 Glas
- 👉 Opale 🗍 Verre
- 👉 Opaal 🗍 Glas

**Quad**

max. 50 W  
 ⚡ 80 ø75 mm  
 EAN 4000870 600153

**600.15**

- 👉 Weiß 🗍 Glas
- 👉 Blanc 🗍 Verre
- 👉 Wit 🗍 Glas

**Kegi**

max. 50 W  
 ⚡ 80 ø110 mm  
 EAN 4000870 600122

**600.12**

- 👉 Weiß 🗍 Glas
- 👉 Blanc 🗍 Verre
- 👉 Wit 🗍 Glas

**Wolbi**

max. 50 W  
 ⚡ 80 ø90 mm  
 EAN 4000870 600078

**600.07**

- 👉 Weiß 🗍 Glas
- 👉 Blanc 🗍 Verre
- 👉 Wit 🗍 Glas

**Zyli**

max. 50 W  
 ⚡ 80 ø70 mm  
 EAN 4000870 600047

**600.04**

- 👉 Weiß 🗍 Glas
- 👉 Blanc 🗍 Verre
- 👉 Wit 🗍 Glas

**DecoSystems Diffusor**

max. 20 W  
 ⚡ 1,5 ø255 mm  
 EAN 4000870 954935

**954.93**

- 👉 Satin 🗍 Kunststoff
- 👉 Satiné
- 🗍 Matière plastique
- 👉 Satijn 🗍 Kunststof

**Tessa**

max. 50 W  
 ⚡ 152 ø255 mm  
 EAN 4000870 603499

**603.49**

- 👉 Dunkelbraun 🗍 Stoff
- 👉 Marron foncé 🗍 Tissus
- 👉 Donkerbruin 🗍 Textiel

**Tessa**

max. 50 W  
 ⚡ 152 ø255 mm  
 EAN 4000870 603505

**603.50**

- 👉 Caramel 🗍 Stoff
- 👉 Caramel 🗍 Tissus
- 👉 Caramel 🗍 Textiel

**Tessa**

max. 50 W  
 ⚡ 152 ø255 mm  
 EAN 4000870 603512

**603.51**

- 👉 Creme 🗍 Stoff
- 👉 Crème 🗍 Tissus
- 👉 Crème 🗍 Textiel

**Tessa**

max. 50 W  
 ⚡ 152 ø255 mm  
 EAN 4000870 603529

**603.52**

- 👉 Hellgrau 🗍 Stoff
- 👉 Gris clair 🗍 Tissus
- 👉 Lichtgrijs 🗍 Textiel

**Tessa**

max. 50 W  
 ⚡ 152 ø255 mm  
 EAN 4000870 603260

**603.26**

- 👉 Weiß 🗍 Stoff
- 👉 Blanc 🗍 Tissus
- 👉 Wit 🗍 Textiel



☞ Klar ☐ Kupfer/Kunststoff  
 ☞ Clair ☐ Cuivre/  
 Matière plastique  
 ☞ Helder ☐ Koper/Kunststof



**Sicherheits-Spannseil, isoliert**  
**Câble de tension de sécurité isolé**  
**Veiligheids-spankabel, geïsoleerd**

2,5 mm<sup>2</sup> ⇔ 12 m  
 EAN 4000870 979693  
**979.069**

4 mm<sup>2</sup> ⇔ 12 m  
 EAN 4000870 979556  
**979.055**

6 mm<sup>2</sup> ⇔ 12 m  
 EAN 4000870 979471  
**979.047**

4 mm<sup>2</sup> ⇔ 100 m  
 EAN 4000870 006566  
**979.057**

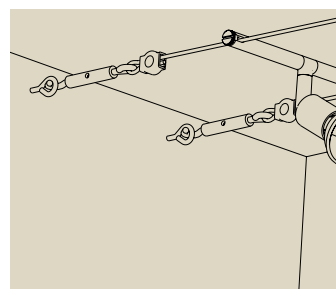

**Spann-Montageset, nicht isoliert**  
**Kit de traction non isolé**  
**Span-montageset, niet geïsoleerd**

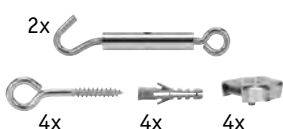

☞ Chrom ☐ Metall  
 ☞ Chrome ☐ Métal  
 ☞ Chroom ☐ Metaal

EAN 4000870 178034  
**178.03**

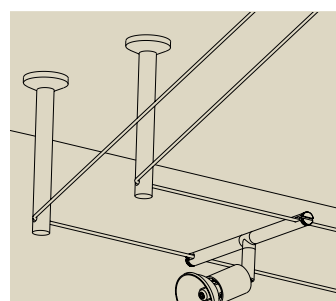

**Umlenker / Abhängung, zum Aufschrauben, 1 Paar**  
**Renvoi d'angle / Support tubes à visser, 1 paire**  
**Ombuiger / Ophanging, opschroefbaar, 1 set**

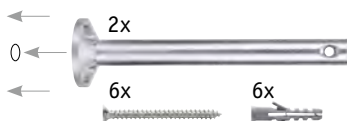

☞ Chrom matt ☐ Metall  
 ☞ Chrome mat ☐ Métal  
 ☞ Chroom mat ☐ Metaal

⇅ 165 ø16 mm  
 EAN 4000870 178065  
**178.06**

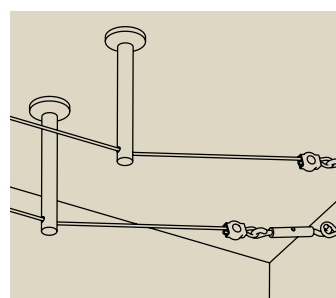

**Umlenker / Abhängung, zum Aufschrauben, 1 Paar**  
**Renvoi d'angle / Support tubes à visser, 1 paire**  
**Ombuiger / Ophanging, opschroefbaar, 1 set**

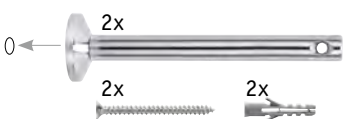

☞ Chrom ☐ Metall  
 ☞ Chrome ☐ Métal  
 ☞ Chroom ☐ Metaal

⇅ 165 ø16 mm  
 EAN 4000870 178249  
**178.24**

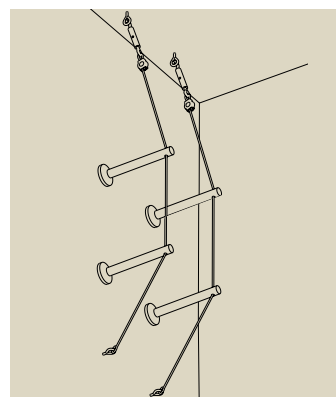

**Spann-Montageset**  
**Kit de traction**  
**Span-montageset**

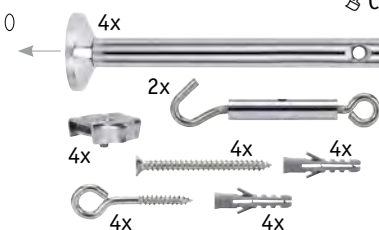

☞ Chrom ☐ Metall  
 ☞ Chrome ☐ Métal  
 ☞ Chroom ☐ Metaal

⇅ 165 ø16 mm  
 EAN 4000870 178348  
**178.34**



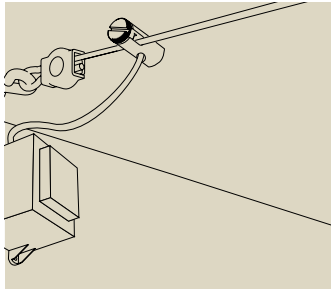

**Stromeinspeisung, 1 Paar**  
**Connecteur d'alimentation, 1 paire**  
**stroomvoeding, 1 set**



- 🔩 Chrom matt  Metall
- 🔩 Chrome mat  Métal
- 🔩 Chroom mat  Metaal

max. 300 W  
 12 V  
 ⚙️ 30 mm ø12 mm 6 mm<sup>2</sup>  
 EAN 4000870 972830  
**972.83** 📦

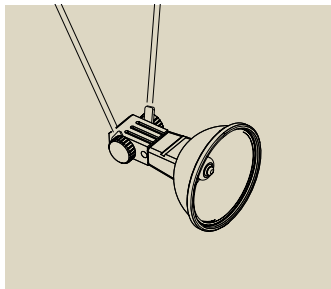

**Socket Lampenhalter, für Seilsysteme**  
**Tête de spot Socket pour câbles**  
**Socket lampenhouder, voor kabelsystemen**



- 🔩 Schwarz  Metall
- 🔩 Noir  Métal
- 🔩 Zwart  Metaal

max. 35 W, G4  
 12 V  
 EAN 4000870 978412  
**978.41** 📦



- 🔩 Schwarz  Metall
- 🔩 Noir  Métal
- 🔩 Zwart  Metaal

max. 50 W, GX5,3  
 12 V  
 EAN 4000870 978450  
**978.45** 📦

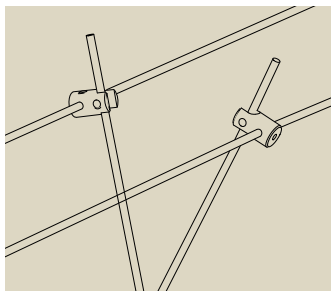

**Seilklotz für Seilsysteme max. 150W / Stangensysteme max. 300W 2er Pack**  
**Sabot contact pour câbles max. 150W / rails max. 300W par 2**  
**Kabelblok voor kabelsystemen max. 150W / stangsystemen max. 300W set van 2 stks**



- 🔩 Chrom  Metall
- 🔩 Chrome  Métal
- 🔩 Chroom  Metaal

max. 150 W  
 12 V  
 EAN 4000870 978191  
**978.019** 📦



# LED Strips & Profiles

- 215 MaxLED – 24 V System
- 230 YourLED – 12 V System
- 243 Complete Sets
- 252 Profiles
- 264 Mobile Strips – USB/Battery



## LED Strips

DE LED-Strips verwandeln Räume in Lieblingsorte

Mit den flexiblen, selbstklebenden LED-Strips, die individuell kürzbar sind, und den passenden Paulmann-Profilen realisieren Sie Ihre Lichtideen. Mit vielfältigem Zubehör steuern Sie Helligkeit oder Lichtfarben der MaxLED Strips per Fernbedienung, Sprache, App oder Sensor.

FR Les Strips LED feront de n'importe quelle pièce votre lieu préféré

Les Strips LED souples, autocollants et raccourcissables associés aux profilés adaptés de Paulmann vous permettent de donner vie à vos idées d'éclairage. De nombreux accessoires vous permettent de contrôler la luminosité ou les températures de couleur de vos Strips MaxLED par télécommande, commande vocale, application ou détecteur.

NL LED-strips veranderen ruimtes in favoriete plekken

Met de flexibele, zelfklevende LED-strips, die individueel inkortbaar zijn, en de bijpassende Paulmann-profielen realiseert u uw lichtideeën. Met de veelzijdige accessoires bestuurt u de helderheid of lichtkleuren van de MaxLED strips met afstandsbediening, spraakbesturing, app of sensor.



DE PoS: Easy to Shop! Einfache und verständliche Endkundenführung von der Bemusterung zur Ware

FR PDV : Easy to Shop ! Accompagnement facile et compréhensible des consommateurs, des échantillons à la marchandise

NL PoS: Easy to Shop! Van voorbeelden tot artikelen eenvoudige en duidelijke consumenteninformatie





	YourLED ECO	YourLED	MaxLED 250	MaxLED 500	MaxLED 1000
<b>Lichtanwendung</b> Application d'éclairage Verlichtingstoepassing	Orientierungslicht Balisage Oriëntatielicht	Dekoratives Licht Éclairage décoratif Decoratief licht	Dekoratives Licht Éclairage décoratif Decoratief licht	Arbeitslicht Éclairage de travail Werklicht	Raumlicht Éclairage d'ambiance Kamerlicht
<b>Spannung/Leistung pro Meter</b> Tension/puissance par mètre Spanning/Vermogen per meter	12V 3,5W/m	12V 3,5W/m	24V 3,5W/m	24V 6W/m	24V 12W/m
<b>Helligkeit in Lumen pro Meter</b> Luminosité en lumens par mètre Helderheid in lumen per meter	160 lm/m	265 lm/m	300 lm/m	550 lm/m	1100 lm/m
<b>Anzahl LEDs pro Meter</b> Nombre de LED par mètre Aantal LED's per meter	30 LED/m	39 LED/m	30 LED/m	72 LED/m	144 LED/m
<b>Maße</b> Dimensions Afmetingen	∅ 10 mm ↔ max. 30 m ≍ 100 mm	∅ 10 mm ↔ max. 24 m ≍ 75 mm	∅ 12,5 mm ↔ max.40 m ≍ 167 mm	∅ 12,5 mm ↔ max. 26 m ≍ 83 mm	∅ 12,5 mm ↔ max. 15 m ≍ 41,5 mm
<b>Mit Beschichtung</b> Avec revêtement de protection Met coating		✓	✓	✓	✓
<b>Ohne Beschichtung</b> Sans revêtement de protection Zonder coating	✓		✓	✓	✓
<b>Lichtfarbe</b> Température de couleur Lichtkleur	3000 K 4000 K RGB	3000 K 6000 K RGB	2700 K 6500 K tunable white RGBW	2700 K 6500 K tunable white RGBW	2700 K 6500 K
	□□ = 230, 232	□□ = 231-232	□□ = 216-217	□□ = 218-220	□□ = 221



**Mit Beschichtung** – auf Möbeln, in Küche & Bad

**Avec revêtement de protection** – meubles de salles de bains / de cuisines

**Met coating** – op meubelen, in de keuken & badkamer



**Ohne Beschichtung** – in Möbeln & Profilen  
**Sans revêtement de protection** – dans les meubles et profilés  
**Zonder coating** – in meubelen & profielen







## MaxLED

- ▶ MaxLED LED-Strips eröffnen durch ihre große Leuchtkraft völlig neuartige Ideen für allgemeines Raum- und Arbeitslicht
- ▶ Eine dichte LED Bestückung sorgt für ein kontinuierliches Lichtbild - ideal zur Verarbeitung in Profilen
- ▶ 1 m Strip MaxLED 1000 entspricht in etwa der Lichtwirkung einer 75 W Glühlampe
- ▶ MaxLED ist in erweiterbaren Basissets oder als Einzelstrips für eigene Konfigurationen erhältlich
- ▶ Licht zum Aufkleben: Dank rückseitigem Klebestreifen ohne Werkzeug schnell verlegt
- ▶ Grâce à leur forte intensité lumineuse, les rubans LED MaxLED ouvrent tout un nouveau monde de possibilités pour l'éclairage de travail et l'éclairage d'intérieur
- ▶ La grande densité de LED diffuse un halo de lumière continue - idéal pour l'installation dans des profilés
- ▶ Un ruban MaxLED 1000 d'1 m permet d'obtenir le même effet de lumière qu'une ampoule à incandescence de 75 W
- ▶ MaxLED est disponible dans des kits de base extensibles ou comme strips individuels pour des configurations personnelles
- ▶ Éclairage à coller : pose rapide sans outil grâce au ruban adhésif double-face
- ▶ MaxLED ledstrips creëren door hun grote lichtkracht volledig nieuwe ideeën voor algemeen ruimte- en werklucht
- ▶ Vele leds zorgen voor een continu lichtbeeld - optimaal voor verwerking in profielen
- ▶ 1 m strip MaxLED 1000 komt qua lichtsterkte overeen met een 75 W gloeilamp
- ▶ MaxLED is verkrijgbaar als uitbreidbare basissets of als afzonderlijke strips voor eigen configuraties
- ▶ Licht om vast te plakken: dankzij hechtstrips aan de achterzijde zonder gereedschap snel gemonteerd





Silber Kunststoff  
 Argent Matière plastique  
 Zilver Kunststof

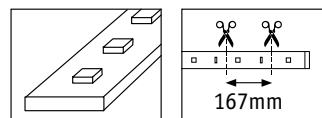

**MaxLED 250** 300 lm/m 30 LED/m  $\updownarrow$  3 mm  $\nearrow$  12,5 mm 230/24V

warm white = 2.700 K



**Set**

$\updownarrow$  3 m  $\xrightarrow{\text{max.}}$  5,5 m | 900 lm | 12 W | incl. 24 VA EAN 4000870 798522 **798.52**

**Strip**

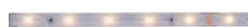

$\updownarrow$  1 m | 300 lm | 4 W EAN 4000870 798539 **798.53**

$\updownarrow$  2,5 m | 750 lm | 10 W EAN 4000870 798546 **798.54**

$\updownarrow$  5 m | 1.500 lm | 19 W EAN 4000870 798553 **798.55**

daylight = 6.500 K



**Set**

$\updownarrow$  3 m  $\xrightarrow{\text{max.}}$  5,5 m | 900 lm | 12 W | incl. 24 VA EAN 4000870 798560 **798.56**

**Strip**



$\updownarrow$  1 m | 300 lm | 4 W EAN 4000870 798577 **798.57**

$\updownarrow$  2,5 m | 750 lm | 10 W EAN 4000870 798584 **798.58**

$\updownarrow$  5 m | 1.500 lm | 19 W EAN 4000870 798591 **798.59**

tunable white = 2.700 - 6.500 K



**Set**



$\updownarrow$  3 m  $\xrightarrow{\text{max.}}$  6 m | 810 lm | 11 W | incl. 24 VA EAN 4000870 798607 **798.60**

**Strip**



$\updownarrow$  1 m | 270 lm | 4 W EAN 4000870 798614 **798.61**

$\updownarrow$  2,5 m | 675 lm | 9 W EAN 4000870 798621 **798.62**

$\updownarrow$  5 m | 1.350 lm | 17,5 W EAN 4000870 798638 **798.63**

RGBW – W = 3.000 K



**Set**



$\updownarrow$  3 m  $\xrightarrow{\text{max.}}$  5 m | 810 lm | 20 W | incl. 36 VA EAN 4000870 798645 **798.64**

**Strip**



$\updownarrow$  1 m | 270 lm | 7 W EAN 4000870 798652 **798.65**

$\updownarrow$  2,5 m | 675 lm | 17 W EAN 4000870 798669 **798.66**

$\updownarrow$  5 m | 1.350 lm | 31,5 W EAN 4000870 798676 **798.67**



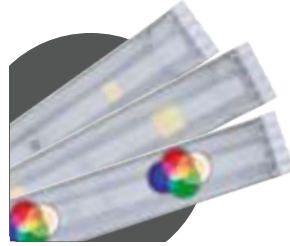

Silber Kunststoff  
 Argent Matière plastique  
 Zilver Kunststof

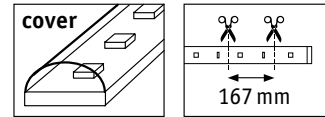

**MaxLED 250** 300 lm/m 30 LED/m  $\updownarrow$  3 mm  $\nearrow$  12,5 mm 230/24V

**warm white = 2.700 K**



**Set**

$\leftrightarrow$ 1,5 m	<u>max.</u> 5,5 m	450 lm	6 W	incl.		EAN 4000870 798683	<b>798.68</b>
$\leftrightarrow$ 3 m	<u>max.</u> 5,5 m	900 lm	12 W	incl.		EAN 4000870 798690	<b>798.69</b>

**Strip**



$\leftrightarrow$ 1 m		300 lm	4 W			EAN 4000870 798706	<b>798.70</b>
$\leftrightarrow$ 2,5 m		750 lm	10 W			EAN 4000870 798713	<b>798.71</b>

**daylight = 6.500 K**



**Set**

$\leftrightarrow$ 1,5 m	<u>max.</u> 5,5 m	450 lm	6 W	incl.		EAN 4000870 798720	<b>798.72</b>
$\leftrightarrow$ 3 m	<u>max.</u> 5,5 m	900 lm	12 W	incl.		EAN 4000870 798737	<b>798.73</b>

**Strip**



$\leftrightarrow$ 1 m		300 lm	4 W			EAN 4000870 798744	<b>798.74</b>
$\leftrightarrow$ 2,5 m		750 lm	10 W			EAN 4000870 798751	<b>798.75</b>

**tunable white = 2.700 - 6.500 K**



**Set**



$\leftrightarrow$ 1,5 m	<u>max.</u> 6 m	405 lm	5,5 W	incl.		EAN 4000870 798768	<b>798.76</b>
$\leftrightarrow$ 3 m	<u>max.</u> 6 m	810 lm	11 W	incl.		EAN 4000870 798775	<b>798.77</b>

**Strip**



$\leftrightarrow$ 1 m		270 lm	4 W			EAN 4000870 798782	<b>798.78</b>
$\leftrightarrow$ 2,5 m		675 lm	9 W			EAN 4000870 798799	<b>798.79</b>

**RGBW – W = 3.000 K**



**Set**



$\leftrightarrow$ 1,5 m	<u>max.</u> 3 m	405 lm	10 W	incl.		EAN 4000870 798805	<b>798.80</b>
$\leftrightarrow$ 3 m	<u>max.</u> 5 m	810 lm	20 W	incl.		EAN 4000870 798812	<b>798.81</b>

**Strip**



$\leftrightarrow$ 1 m		270 lm	7 W			EAN 4000870 798829	<b>798.82</b>
$\leftrightarrow$ 2,5 m		675 lm	17 W			EAN 4000870 798836	<b>798.83</b>



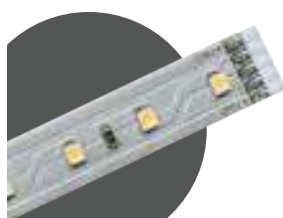

Silber Metall  
 Argent Métal  
 Zilver Metaal

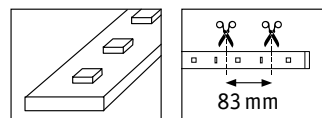

**MaxLED 500** 550 lm/m 72 LED/m  $\updownarrow$  3 mm  $\nearrow$  12,5 mm 230/24 V

**warm white = 2.700 K**

**Set**



$\leftrightarrow$ 1,5 m	<u>max.</u> 3 m	825 lm	9 W	incl.  20 VA		EAN 4000870 705773	<b>705.77</b>
$\leftrightarrow$ 3 m	<u>max.</u> 5,5 m	1,650 lm	18 W	incl.  36 VA		EAN 4000870 705797	<b>705.79</b>
$\leftrightarrow$ 5 m	<u>max.</u> 16,5 m	2,750 lm	30 W	incl.  75 VA		EAN 4000870 706046	<b>706.04</b>
$\leftrightarrow$ 10 m	<u>max.</u> 20 m	5,500 lm	50 W	incl.  80 VA		EAN 4000870 708293	<b>708.29</b>

**Strip**



$\leftrightarrow$ 1 m		550 lm	6 W			EAN 4000870 705810	<b>705.81</b>
$\leftrightarrow$ 2,5 m		1,375 lm	15 W			EAN 4000870 708279	<b>708.27</b>

**daylight = 6.500 K**

**Set**



$\leftrightarrow$ 1,5 m	<u>max.</u> 3,5 m	825 lm	9 W	incl.  20 VA		EAN 4000870 705780	<b>705.78</b>
$\leftrightarrow$ 3 m	<u>max.</u> 6,5 m	1,650 lm	18 W	incl.  36 VA		EAN 4000870 705803	<b>705.80</b>
$\leftrightarrow$ 5 m	<u>max.</u> 13 m	2,750 lm	30 W	incl.  60 VA		EAN 4000870 706053	<b>706.05</b>
$\leftrightarrow$ 10 m	<u>max.</u> 20 m	5,500 lm	50 W	incl.  75 VA		EAN 4000870 708309	<b>708.30</b>

**Strip**



$\leftrightarrow$ 1 m		550 lm	6 W			EAN 4000870 705827	<b>705.82</b>
$\leftrightarrow$ 2,5 m		1,375 lm	15 W			EAN 4000870 708286	<b>708.28</b>

**warm white = 2.700 K**



**Bluetooth Set**



$\leftrightarrow$ 10 m	<u>max.</u> 20 m	5.500 lm	50 W	incl.  80 VA		EAN 4000870 709078	<b>709.07</b>
------------------------	------------------	----------	------	--------------	--	--------------------	---------------

**daylight = 6.500 K**



**Bluetooth Set**



$\leftrightarrow$ 10 m	<u>max.</u> 20 m	5.500 lm	50 W	incl.  75 VA		EAN 4000870 709085	<b>709.08</b>
------------------------	------------------	----------	------	--------------	--	--------------------	---------------



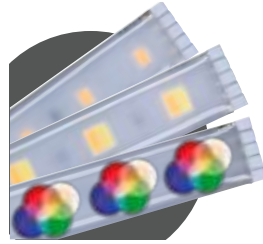

Silber Kunststoff  
 Argent Matière plastique  
 Zilver Kunststof

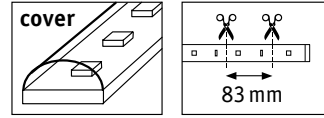

**MaxLED 500** 550 lm/m 60/72 LED/m  $\updownarrow$  4 mm  $\nearrow$  12,5 mm 230/24V

warm white = 2.700 K

**Set**



$\leftrightarrow$  1,5 m max. 3 m | 825 lm | 9 W | incl. 20 VA EAN 4000870 706688 **706.68**

$\leftrightarrow$  3 m max. 5,5 m | 1.650 lm | 18 W | incl. 36 VA EAN 4000870 706664 **706.66**

**Strip**



$\leftrightarrow$  1 m | 550 lm | 6 W EAN 4000870 706633 **706.63**

$\leftrightarrow$  2,5 m | 1.375 lm | 15 W EAN 4000870 705490 **705.49**  
**new**

daylight = 6.500 K

**Set**



$\leftrightarrow$  1,5 m max. 3,5 m | 825 lm | 9 W | incl. 20 VA EAN 4000870 706671 **706.67**

$\leftrightarrow$  3 m max. 6,5 m | 1.650 lm | 18 W | incl. 36 VA EAN 4000870 706657 **706.65**

**Strip**



$\leftrightarrow$  1 m | 550 lm | 6 W EAN 4000870 706640 **706.64**

$\leftrightarrow$  2,5 m | 1.375 lm | 15 W EAN 4000870 705483 **705.48**  
**new**

tunable white = 3.000 - 6.500 K

**Set**



$\leftrightarrow$  1,5 m max. 3 m | 825 lm | 10 W | incl. 20 VA EAN 4000870 706237 **706.23**

$\leftrightarrow$  3 m max. 5 m | 1.650 lm | 20 W | incl. 36 VA EAN 4000870 706244 **706.24**

**Strip**



$\leftrightarrow$  1 m | 550 lm | 7 W EAN 4000870 706305 **706.30**

$\leftrightarrow$  2,5 m | 1.375 lm | 16 W EAN 4000870 705506 **705.50**  
**new**

RGBW – W = 3.000 K

**Set**



$\leftrightarrow$  1,5 m max. 3 m | 750 lm | 18 W | incl. 36 VA EAN 4000870 706275 **706.27**

$\leftrightarrow$  3 m max. 6 m | 1.500 lm | 36 W | incl. 60 VA EAN 4000870 706282 **706.28**

**Strip**



$\leftrightarrow$  1 m | 500 lm | 12 W EAN 4000870 706343 **706.34**

$\leftrightarrow$  2,5 m | 1.250 lm | 30 W EAN 4000870 705513 **705.51**  
**new**

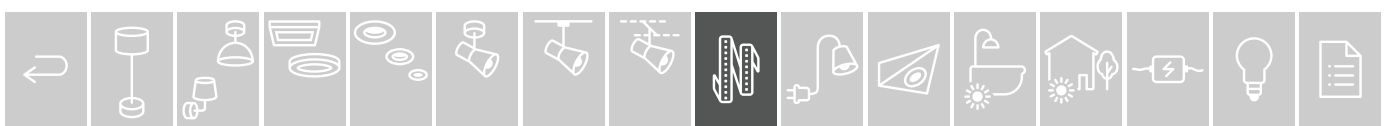



- |  |  |  |
|--|--|--|
| <ul style="list-style-type: none"> <li>▶ Selbstklebende LED-Strips zur Unterschrankbeleuchtung</li> <li>▶ Hochwertiger Kleber sorgt für dauerhaften Halt</li> <li>▶ Beschichtung schützt vor Spritzwasser (IP44)</li> <li>▶ Geeignet für alle Standardküchenmaße</li> <li>▶ Inkl. Touchschalter zum Dimmen und Schalten</li> <li>▶ Inkl. Kabeln zum Überbrücken von Distanzen (z.B. Dunstabzugshaube)</li> </ul> | <ul style="list-style-type: none"> <li>▶ Strips LED autocollants pour l'éclairage des sous-meubles</li> <li>▶ Colle de haute qualité pour une tenue durable</li> <li>▶ Le revêtement protège contre l'aspersion (IP44)</li> <li>▶ Convient pour toutes les dimensions de cuisines standards</li> <li>▶ Fourni avec interrupteur tactile pour varier l'intensité et commuter</li> <li>▶ Fourni avec des câbles pour couvrir les distances (p. ex. hotte aspirante)</li> </ul> | <ul style="list-style-type: none"> <li>▶ Zelfklevende LED-strips als verlichting onder kastjes</li> <li>▶ Een hoogwaardig plakmiddel voor een langdurige bevestiging</li> <li>▶ Coating beschermt tegen spatwater (IP44)</li> <li>▶ Geschikt voor alle keukens met standaard afmetingen</li> <li>▶ Incl. Touch-schakelaar om te dimmen en te schakelen</li> <li>▶ Incl. kabels voor het overbruggen van afstanden (bijv. afzuigkap)</li> </ul> |
|--|--|--|



🔪 Silber 📦 Kunststoff  
🔪 Argent 📦 Matière plastique  
🔪 Zilver 📦 Kunststof

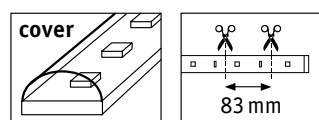

**MaxLED 500 Comfort Set Kitchen Touch Sensor**    550 lm/m    72 LED/m    3 mm x 12,5 mm    230/24 V

● warm white = 2.700 K



**Set**

↔ **1,8 m**    ↔ **max. 2,8 m**    |    3x310 lm    |    3,1 W    |    incl. ⚡ 20 VA    🔪    EAN 4000870 798386    📦 **798.38**



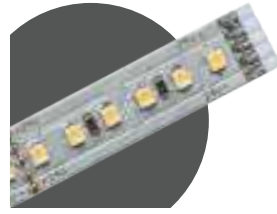

Silber Metall  
 Argent Métal  
 Zilver Metaal

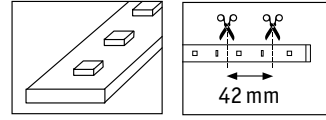

**MaxLED 1000** 1100 lm/m 144 LED/m  $\updownarrow$  3 mm  $\nearrow$  12,5 mm 230/24 V

**warm white = 2.700 K**



**Set**

$\leftrightarrow$ 1,5 m	<u>max.</u> 5 m	1,650 lm	18 W	incl.  60 VA	EAN 4000870 705858 <b>705.85</b>
$\leftrightarrow$ 3 m	<u>max.</u> 7 m	3,300 lm	35 W	incl.  75 VA	EAN 4000870 705889 <b>705.88</b>

**Strip**



$\leftrightarrow$ 1 m	1,100 lm	12 W	EAN 4000870 705681 <b>705.68</b>
$\leftrightarrow$ 2,5 m	2.750 lm	32 W	EAN 4000870 798140 <b>798.14</b>

**daylight = 6.500 K**



**Set**

$\leftrightarrow$ 1,5 m	<u>max.</u> 3 m	1,650 lm	18 W	incl.  36 VA	EAN 4000870 705865 <b>705.86</b>
$\leftrightarrow$ 3 m	<u>max.</u> 5,5 m	3,300 lm	35 W	incl.  60 VA	EAN 4000870 705896 <b>705.89</b>

**Strip**



$\leftrightarrow$ 1 m	1,100 lm	12 W	EAN 4000870 705698 <b>705.69</b>
-----------------------	----------	------	----------------------------------



Silber Kunststoff  
 Argent Matière plastique  
 Zilver Kunststof

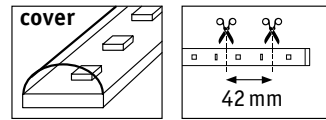

**MaxLED 1000** 1100 lm/m 144 LED/m  $\updownarrow$  4 mm  $\nearrow$  12,5 mm 230/24 V

**warm white = 2.700 K**



**Set**

$\leftrightarrow$ 1,5 m	<u>max.</u> 5 m	1.650 lm	18 W	incl.  60 VA	EAN 4000870 706725 <b>706.72</b>
$\leftrightarrow$ 3 m	<u>max.</u> 7 m	3.300 lm	35 W	incl.  75 VA	EAN 4000870 706701 <b>706.70</b>

**Strip**



$\leftrightarrow$ 1 m	1.100 lm	12 W	EAN 4000870 706763 <b>706.76</b>
-----------------------	----------	------	----------------------------------

**daylight = 6.500 K**



**Set**

$\leftrightarrow$ 1,5 m	<u>max.</u> 3 m	1.650 lm	18 W	incl.  36 VA	EAN 4000870 706718 <b>706.71</b>
$\leftrightarrow$ 3 m	<u>max.</u> 5,5 m	3.300 lm	35 W	incl.  60 VA	EAN 4000870 706695 <b>706.69</b>

**Strip**



$\leftrightarrow$ 1 m	1.100 lm	12 W	EAN 4000870 706756 <b>706.75</b>
-----------------------	----------	------	----------------------------------





## MaxLED Flow

- ▶ MaxLED Flow - raus aus dem Versteck, rein ins Rampenlicht
- ▶ Auch ausgeschaltet keine LED's zu sehen: der Stripe kann offen im Sichtbereich an der Wand, Einrichtung oder an Möbelstücken platziert werden
- ▶ Die filigrane Abmessung von 1x1cm passt zu jedem Einrichtungs-Stil
- ▶ Inkl. durchsichtiger Clip Halterungen, Schrauben und Dübel. Der Strip kann linear gerade verlegt werden oder wer es kreativer mag kann den Stripe auch flexibel geschwungen z.B. als leuchtendes Wandornament verlegen
- ▶ Die Lichtwirkung an der Wand ist besonders effektiv da der Stripe einen Ausstrahlwinkel von 180°- Grad hat
- ▶ Kann mit allen MaxLED Zubehör Komponenten wie Verbinder (RGB und Warmweiß) und Steuerungen (Warmweiß) kombiniert werden
- ▶ MaxLED Flow - Ne restez pas dans le noir, entrez sous les feux de la rampe !
- ▶ Aucune LED visible même éteint : le Strip peut être exposé contre un mur, un équipement ou un meuble.
- ▶ La taille discrète de 1x1 cm s'adapte à tous les styles d'aménagement
- ▶ Avec supports à clip transparent, vis et chevilles. Le strip peut être posé en ligne droite ou si l'on préfère un peu plus de créativité, il peut être coudé par exemple comme décoration murale éclairée.
- ▶ L'effet lumineux contre le mur est particulièrement marquant car le strip a un angle de rayonnement de 180°.
- ▶ Peut être combiné à tous les composants d'accessoires MaxLED tels que connecteurs (RGB et Blanc chaud) et commandes (Blanc chaud).
- ▶ MaxLED Flow - weg uit de schuilplaats, terug in de schijnwerpers
- ▶ Ook als de LEDs zijn uitgeschakeld, vallen ze niet op: de strip kan dus in het zicht aan de wand, aan het interieur of aan meubels worden bevestigd
- ▶ De filigrane afmetingen van 1 x 1 cm passen in elke inrichting
- ▶ Incl. doorzichtige klemmen, schroeven en pluggen. De strip kan lineair worden verlegd of wie iets creatievers in gedachten heeft, kan de strip ook gebogen monteren, bv. als verlichtend wandornament
- ▶ Het lichteffect aan de wand is erg doeltreffend, omdat de strip een uitstraalhoek van 180 graden heeft
- ▶ Kan met al het MaxLED-toebehoren zoals verbinders (RGB en Warmwit) en besturingen (Warmwit) worden gecombineerd





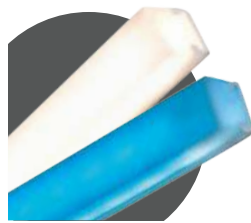

- 👉 Weiß 🏠 Kunststoff
- 👉 Blanc 🏠 Matière plastique
- 👉 Wit 🏠 Kunststof



**MaxLED Flow**

230/24V

🟡 warm white = 2.700 K

- ▶ Grundbeleuchtung: 1000 lm/m & 180 LEDs/m
- ▶ Éclairage de base : 1000 lm/m & 180 LED/m
- ▶ Vloerverlichting: 1000 lm/m & 180 LEDs/m
- ▶ Kann mit allen MaxLED Steuerungen (Warmweiß) kombiniert werden
- ▶ Peut être combiné à tous les commandes (Blanc chaud) MaxLED.
- ▶ Kan met al het MaxLED-besturingen (Warmwit) worden gecombineerd

**Set**



↔ 1,5 m		1.500 lm		21 W		incl. 📶 24 VA	🏠	EAN 4000870 709627	🛒 709.62
↔ 3 m		3.000 lm		37 W		incl. 📶 50 VA	👉	EAN 4000870 709634	🛒 709.63
↔ 5 m		5.000 lm		52 W		incl. 📶 75 VA	👉	EAN 4000870 709641	🛒 709.64

🌈 RGB

- ▶ Das RGB Set beinhaltet eine hochwertige Funk-Steuerung inkl. Wandhalterung für die Fernbedienung
- ▶ Le kit RGB comprend une télécommande radio de haute qualité avec support mural
- ▶ De RGB-set bevat een hoogwaardige draadloze besturing incl. wandhouder voor de afstandsbediening



**Set**



↔ 1,5 m		600 lm		13,5 W		incl. 📶 24 VA	🏠	EAN 4000870 709658	🛒 709.65
↔ 3 m		1.200 lm		27 W		incl. 📶 36 VA	👉	EAN 4000870 709665	🛒 709.66
↔ 5 m		2.000 lm		43 W		incl. 📶 75 VA	👉	EAN 4000870 709672	🛒 709.67



Wei Kunststoff  
 Blanc Matire plastique  
 Wit Kunststof



**Flex-Connector 10cm**

6 ⇔ 100 ↗ 15 mm  
 EAN 4000870 705766  
**705.76**



**Flex-Connector 1m**

6 mm ↗ 15 mm ⇔ 1 m  
 EAN 4000870 705759  
**705.75**



**Flex-Connector 5m**

6 mm ↗ 15 mm ⇔ 5 m  
 EAN 4000870 705742  
**705.74**

- ▶ Der MaxLED Splitter teilt das Stripe-System in 2 Strnge.
- ▶ Das Y Stck hat am Eingang 10cm und am Ausgang 2x 20cm Stripes.
- ▶ Die insgesamt 30cm Kabel knnen hervorragend zur Mitteleinspeisung genutzt werden, z.B. in einem Profil System.
- ▶ Zustzlich knnen damit ganz einfach Abzweigungen verlegt werden, z.B. beim Hinterleuchten eines Mbels oder einer TV Wand.

- ▶ Le rpartiteur MaxLED partage le systme de strips en 2 branches.
- ▶ Le connecteur en Y accepte des strips de 10 cm en entre et 2 x 20 cm en sortie.
- ▶ Les câbles d'une longueur totale de 30 cm conviennent remarquablement bien à une alimentation au milieu, par exemple dans un systme de profils.
- ▶ Il est de plus extrmement facile de crer des drivations, par exemple pour rtroclairer un meuble ou un mur TV.

- ▶ De MaxLED-splitter splitst het stripsysteem in twee strengen.
- ▶ Het Y-stuk heeft aan de ingang 10 cm en aan de uitgang 2 x 20 cm strips.
- ▶ De in totaal 30 cm lange kabels kunnen uitstekend worden gebruikt als middenvoeding, bijvoorbeeld in een profielsysteem.
- ▶ Bovendien kunnen aftakkingen hiermee heel eenvoudig mee worden verlegd, bijvoorbeeld om meubels en aan de muur gemonteerde tv's van achteren te verlichten.



**MaxLED Y Splitter 30cm**

max. 144 W  
 7 ⇔ 30 ↗ 12 mm  
 EAN 4000870 798133  
**798.13**

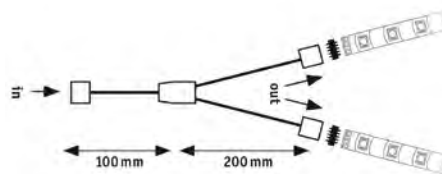

**MaxLED Edge-Connector**

max. 144 W  
 12 ⇔ 17 ↗ 16 mm  
 EAN 4000870 706152  
**706.15**



**MaxLED Edge-Connector 90°**

max. 144 W  
 4,5 ⇔ 25 ↗ 25 mm  
 EAN 4000870 706169  
**706.16**



**MaxLED X-Connector**

max. 144 W  
 6 ⇔ 32 ↗ 28 mm  
 EAN 4000870 706176  
**706.17**



**MaxLED Clip-to-Clip Connector**

max. 144 W  
 4,5 ⇔ 20 ↗ 13,5 mm  
 EAN 4000870 706183  
**706.18**



**Universal MaxLED Connector**

max. 144 W  
 7 ⇔ 100 ↗ 19 mm  
 EAN 4000870 709191  
**709.19**



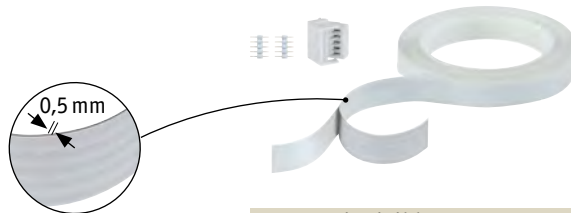

**MaxLED invisible connector 3 m**

max. 144/96 W  
 24 V  
 ⌀12 mm ⇔17,5 mm ↗0,5 mm ⇔3 m  
 EAN 4000870 798287  
**798.28**

- 👉 Weiß 🗄️ Kunststoff
- 👉 Blanc 🗄️ Matière plastique
- 👉 Wit 🗄️ Kunststof



**MaxLED invisible connector 5 m**

max. 144/96 W  
 24 V  
 ⌀12 mm ⇔17,5 mm ↗0,5 mm ⇔5 m  
 EAN 4000870 798294  
**798.29**

- 👉 Weiß 🗄️ Kunststoff
- 👉 Blanc 🗄️ Matière plastique
- 👉 Wit 🗄️ Kunststof

**Power Supply 24V DC**

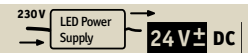

- ▶ Energieeffizientes elektronisches Vorschaltgerät mit langer Lebensdauer
- ▶ Einfaches Stecksystem zur problemlosen Montage
- ▶ Inkl. 1,5m Primär Zuleitung mit Eurostecker & 1m Sekundärleitung
- ▶ Inkl. 5-Pin-Stecker zum einfachen Verbinden der Strips
- ▶ Ballast électronique écoénergétique à longue durée de vie
- ▶ Système de connexion simple pour un montage sans problème
- ▶ Avec câble primaire 1,5 m avec connecteur euro & câble secondaire 1 m
- ▶ Avec fiche 5 broches pour faciliter la connexion des Strips
- ▶ Energie-efficiënt elektronisch voorschakelapparaat met lange levensduur
- ▶ Eenvoudig stekkersysteem voor probleemloze montage
- ▶ Incl. primaire toevoer van 1,5 m met eurostecker & secundaire toevoer van 1 m
- ▶ Incl. 5-pin stecker voor eenvoudige verbinding met de strips



**Universal LED Power Supply 12W 24V DC**

max. 12 W  
 230/24 V, incl. ⚡ 12 VA  
 ⌀63 ⇔40 ↗26 mm  
 EAN 4000870 798355  
**798.35**



**Universal LED Power Supply 36W 24V DC**

max. 36 W  
 230/24 V, incl. ⚡ 36 VA  
 ⌀101 ⇔51 ↗31 mm  
 EAN 4000870 798379  
**798.37**

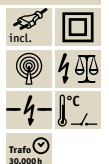

**Power Supply 24V DC**

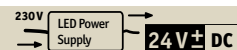

- ▶ Energieeffizientes elektronisches Vorschaltgerät mit langer Lebensdauer
- ▶ Einfaches Stecksystem zur problemlosen Montage
- ▶ Inkl. 1,5m Primär Zuleitung mit Eurostecker & 1m Sekundärleitung
- ▶ Inkl. 5-Pin-Stecker zum einfachen Verbinden der Strips
- ▶ Ballast électronique écoénergétique à longue durée de vie
- ▶ Système de connexion simple pour un montage sans problème
- ▶ Avec câble primaire 1,5 m avec connecteur euro & câble secondaire 1 m
- ▶ Avec fiche 5 broches pour faciliter la connexion des Strips
- ▶ Energie-efficiënt elektronisch voorschakelapparaat met lange levensduur
- ▶ Eenvoudig stekkersysteem voor probleemloze montage
- ▶ Incl. primaire toevoer van 1,5 m met eurostecker & secundaire toevoer van 1 m
- ▶ Incl. 5-pin stecker voor eenvoudige verbinding met de strips



**Power Supply 24V DC**

max. 40W  
230/24V, incl. 40VA  
24 ↔ 52 166 mm  
EAN 4000870 798317  
**798.31**



- ↳ Weiß Kunststoff
- ↳ Blanc Matière plastique
- ↳ Wit Kunststof

**Power Supply 24V DC**

max. 60W  
230/24V, incl. 60VA  
32 ↔ 61 184 mm  
EAN 4000870 798300  
**798.30**



- ↳ Weiß Kunststoff
- ↳ Blanc Matière plastique
- ↳ Wit Kunststof

**Power Supply 24V DC**

max. 150W  
230/24V, incl. 150VA  
34 ↔ 210 167 mm  
EAN 4000870 709764  
**709.76**



- ↳ Weiß Kunststoff
- ↳ Blanc Matière plastique
- ↳ Wit Kunststof

Maximum length of your system	40W		60W		150W	
	→	↔*	→	↔*	→	↔*
<b>MaxLED 250</b> Warm white, Daylight, Tunable White	<b>11m</b>	<b>10m</b> (5m + 5m)	<b>17m</b>	<b>16m</b> (8m + 8m)	<b>30m</b>	<b>40m</b> (20m + 20m)
<b>MaxLED 250</b> RGBW	<b>6,5m</b>	<b>6m</b> (3m + 3m)	<b>10m</b>	<b>9m</b> (4,5m + 4,5m)	<b>20m</b>	<b>22m</b> (11m + 11m)
<b>MaxLED 500</b> Warm white	<b>6,5m</b>	<b>6m</b> (3m + 3m)	<b>10m</b>	<b>9m</b> (4,5m + 4,5m)	<b>20m</b>	<b>22m</b> (11m + 11m)
<b>MaxLED 500</b> Daylight	<b>7m</b>	<b>6m</b> (3m + 3m)	<b>13m</b>	<b>11m</b> (5,5m + 5,5m)	<b>24m</b>	<b>26m</b> (13m + 13m)
<b>MaxLED 500</b> Tunable White	<b>6,5m</b>	<b>6m</b> (3m + 3m)	<b>10m</b>	<b>9m</b> (4,5m + 4,5m)	<b>20m</b>	<b>22m</b> (11m + 11m)
<b>MaxLED 500</b> RGBW	<b>3,5m</b>	<b>3m</b> (1,5m + 1,5m)	<b>6m</b>	<b>5m</b> (2,5m + 2,5m)	<b>10m</b>	<b>16m</b> (8m + 8m)
<b>MaxLED 1000</b> Warm white	<b>3m</b>	<b>2m</b> (1m + 1m)	<b>5m</b>	<b>4m</b> (2m + 2m)	<b>10m</b>	<b>12m</b> (6m + 6m)
<b>MaxLED 1000</b> Daylight	<b>3,5m</b>	<b>3m</b> (1,5m + 1,5m)	<b>5,5m</b>	<b>4m</b> (2m + 2m)	<b>10m</b>	<b>15m</b> (7,5m + 7,5m)

\*use with 798.13 Y-Splitter or 706.17 X-Connector

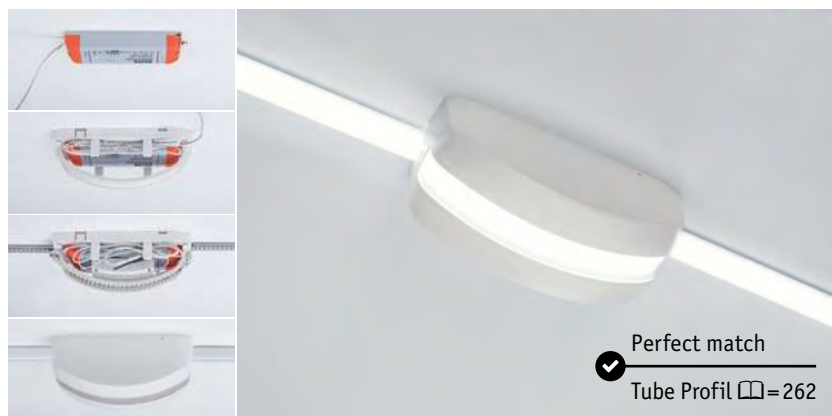

**Shining Case**

90 ↔ 220 92 mm  
EAN 4000870 705162  
**705.16**

- ↳ Weiß matt Kunststoff
- ↳ Blanc dépoli Matière plastique
- ↳ Wit mat Kunststof





- 🔗 Weiß 📦 Kunststoff
- 🔗 Blanc 📦 Matière plastique
- 🔗 Wit 📦 Kunststof

- ▶ Einschalt- und Abschaltautomatik durch Bewegungsmelder bei Nacht.
- ▶ Zeit einstellbar 30 sec. bis mind. 10min.
- ▶ 100 ° Erfassungswinkel
- ▶ Erfassungsradius 0-5m
- ▶ Mise en marche et arrêt automatiques par détecteur de mouvement la nuit.
- ▶ Durée réglable de 30 s à au moins. 10 min
- ▶ Angle de diffusion 100°
- ▶ Angle de couverture 0 à 5 m
- ▶ Automatische in- und uitschakeling door bewegingsmelder ,s nachts.
- ▶ Tijd instelbaar 30 sec. tot minimum 10 min.
- ▶ 100° detectiehoek
- ▶ Detectiebereik 0-5 m



#### MaxLED Night PIR Sensor max. 144W 24 V

max. 144 W  
DC 24 V  
⌀33 ⇄48 ↗35 mm  
EAN 4000870 709740  
**709.74** 📦

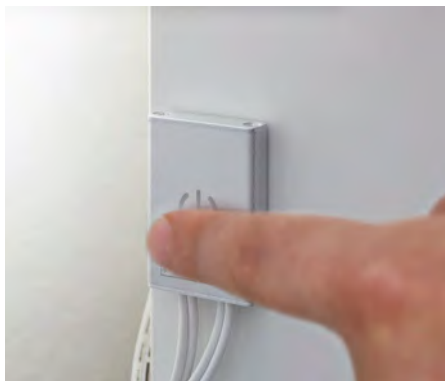

- 🔗 Silber 📦 Metall
- 🔗 Argent 📦 Métal
- 🔗 Zilver 📦 Metaal

- ▶ Schaltet An/Aus bei antippen. Dimmt bei längerem drücken.
- ▶ Inkl. Memory Function
- ▶ Inkl. Klebepads
- ▶ S'allume et s'éteint au toucher. Maintenez la touche enfoncée pour varier l'intensité lumineuse.
- ▶ Avec effet mémoire
- ▶ Pattes adhésives incluses
- ▶ Schakelt aan/uit bij aantikken. Dimt bij langer induwen.
- ▶ Incl. memory effect
- ▶ Incl. kleefpads



#### MaxLED Touch Switch max. 144W 24 V

max. 144 W  
DC 24 V  
⌀8,5 ⇄43 ↗30 mm  
EAN 4000870 709757  
**709.75** 📦

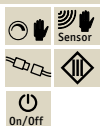

- ▶ Sensoren im Kleinformat für einfarbige LED-Strips – perfekt geeignet für Profile\*
- ▶ Détecteurs miniatures pour les Strips LED unicolores - parfaitement adaptés aux profilés\*
- ▶ Sensoren in het allerkleinste formaat voor eenkleurige LED-strips – optimaal geschikt voor profielen\*

- ▶ Näherungsschalter (< 5 cm) zur berührungslosen Steuerung
- ▶ Détecteur de proximité (< 5 cm) pour la commande sans contact
- ▶ Naderingsschakelaar (< 5 cm) voor contactloze besturing



**MaxLED Touchless Sensor**

max. 144 W  
DC 24 V

↕7 ↔56,5 ↗12,5 mm

EAN 4000870 798409

**798.40**



Touchless 3-5cm

<0,5 s = ⏻ On/Off

>0,5 s = 🌞 dim

incl. memory function

\*Delta Profil, Duo Profil, Square Profil, Tube Profil, Step Profil □=254-262

- ▶ Bewegungsmelder zur berührungslosen Steuerung
- ▶ Détecteur de mouvement pour la commande sans contact
- ▶ Bewegingsmelder voor contactloze besturing



**MaxLED Night PIR Sensor**

max. 144 W  
DC 24 V

↕16 ↔56,5 ↗12,5 mm

EAN 4000870 798416

**798.41**

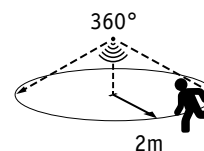

Softstart  
0-100% = 2s

\*Delta Profil, Duo Profil, Square Profil, Tube Profil, Step Profil □=254-262

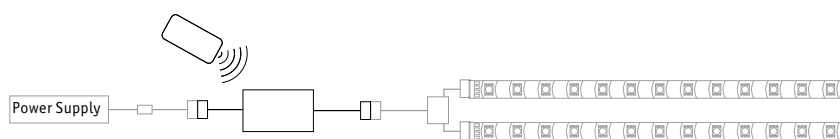

- 👉 Weiß 🧱 Kunststoff
- 👉 Blanc 🧱 Matière plastique
- 👉 Wit 🧱 Kunststof

- ▶ Zum Schalten oder Dimmen einzelner MaxLED Strips
- ▶ IR-Controller: Sichtkontakt zum Empfänger nötig
- ▶ Funk Controller 2,4GHz: Kein Sichtkontakt zum Empfänger nötig, perfekt zur versteckten Installation
- ▶ Pour commuter ou faire varier l'intensité de rubans MaxLED individuels
- ▶ Controller IR : Contact visuel nécessaire avec le destinataire
- ▶ Radio Controller 2,4 GHz : Aucun contact visuel nécessaire avec le destinataire, parfait pour une installation cachée
- ▶ Voor het schakelen of dimmen van afzonderlijke MaxLED-strips
- ▶ IR-controller Visueel contact met de ontvanger vereist
- ▶ Draadloze controller 2,4 GHz: Geen visueel contact met de ontvanger vereist, perfect voor verborgen installatie



**Dimm/Switch Controller IR**

max. 144 W  
1xCR 2025/3V  
DC 24 V

↕22 ↔50 ↗35 mm

EAN 4000870 706831

**706.83**



**Dimm/Switch-Controller 2.4GHz**

max. 144 W  
2xAAA/1,5V (Micro)  
DC 24 V

↕22,5 ↔85 ↗45 mm

EAN 4000870 706190

**706.19**



**RGBW-Controller 2.4GHz**

max. 144 W  
2xAAA/1,5V (Micro)  
DC 24 V

↕20 ↔110 ↗53 mm

EAN 4000870 797976

**797.97**



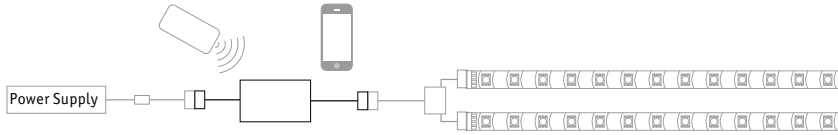

- ↳ Weiß 田 Kunststoff
- ↳ Blanc 田 Matière plastique
- ↳ Wit 田 Kunststof

smart  
controllable  
**Bluetooth®**



**Switch/Dimm Controller**

max. 144 W  
DC 24 V  
⌀19 ⇄39 ↗80 mm  
EAN 4000870 500026  
**500.02**



**Tunable White Controller**

max. 144 W  
DC 24 V  
⌀19 ⇄39 ↗80 mm  
EAN 4000870 500033  
**500.03**



**RGBW Controller**

max. 144 W  
DC 24 V  
⌀19 ⇄39 ↗80 mm  
EAN 4000870 500040  
**500.04**



- ↳ Weiß/Grau 田 Kunststoff
- ↳ Blanc/Gris 田 Matière plastique
- ↳ Wit/Grijs 田 Kunststof

smart  
controllable  
**zigbee**



**Switch/Dimm Controller**

max. 144 W  
DC 24 V  
⌀28 ⇄38 ↗95 mm  
EAN 4000870 500453  
**500.45**

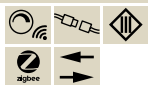

**Tunable White Controller**

max. 144 W  
DC 24 V  
⌀28 ⇄38 ↗95 mm  
EAN 4000870 500460  
**500.46**



**RGBW Controller**

max. 144 W  
DC 24 V  
⌀28 ⇄38 ↗95 mm  
EAN 4000870 500477  
**500.47**





Metall  
Métal  
Metaal

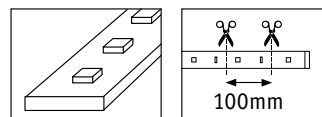

**YourLED ECO** 160 lm/m 30 LED/m  $\updownarrow$  3 mm  $\nearrow$  10 mm 230/12V

warm white = 3.000 K



**Set**

$\leftrightarrow$  3 m  $\xrightarrow{\text{max.}}$  6 m | 480 lm | 6,8 W | incl. 12 VA EAN 4000870 704288 **704.28**



**Strip**



$\leftrightarrow$  1 m | 160 lm | 2,4 W EAN 4000870 704592 **704.59**

$\leftrightarrow$  3 m | 480 lm | 6,8 W EAN 4000870 702543 **702.54**

$\leftrightarrow$  5 m | 780 lm | 10,5 W EAN 4000870 702550 **702.55**

neutral white = 4.000 K



**Set**

$\leftrightarrow$  3 m  $\xrightarrow{\text{max.}}$  6 m | 540 lm | 6,8 W | incl. 12 VA EAN 4000870 704295 **704.29**



**Strip**



$\leftrightarrow$  1 m | 180 lm | 2,4 W EAN 4000870 704585 **704.58**

$\leftrightarrow$  3 m | 540 lm | 6,8 W EAN 4000870 702567 **702.56**

$\leftrightarrow$  5 m | 900 lm | 10,5 W EAN 4000870 702574 **702.57**

RGB



**Set**



$\leftrightarrow$  3 m  $\xrightarrow{\text{max.}}$  5 m | 330 lm | 14,5 W | incl. 24 VA EAN 4000870 704301 **704.30**



**Strip**



$\leftrightarrow$  3 m | 330 lm | 14,5 W EAN 4000870 702529 **702.52**

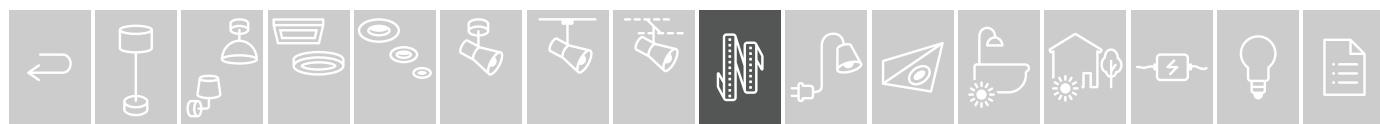

$\leftrightarrow$  5 m | 550 lm | 18 W EAN 4000870 702536 **702.53**

$\leftrightarrow$  1 m | 110 lm | 6 W EAN 4000870 704608 **704.60**



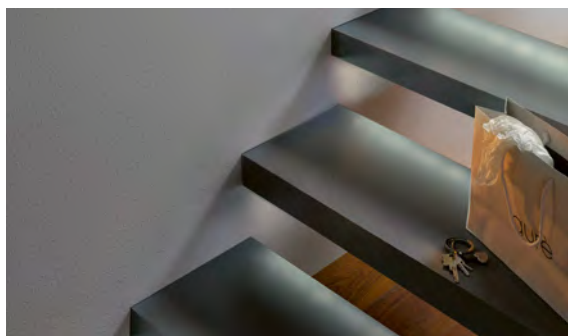



 Kunststoff  
 Matière plastique  
 Kunststof

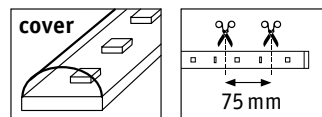







**YourLED** 265 lm/m 39 LED/m  $\updownarrow$  3 mm  $\nearrow$  10 mm 230/12V

 warm white = 3.000 K



**Set**

$\leftrightarrow$ 1,5 m $\xrightarrow{\text{max.}}$ 4,8 m	400 lm	4,5 W	incl.  12 VA 	EAN 4000870 703175  <b>703.17</b>
$\leftrightarrow$ 3 m $\xrightarrow{\text{max.}}$ 7,5 m	800 lm	7,5 W	incl.  18 VA 	EAN 4000870 703205  <b>703.20</b>

**Strip**









$\leftrightarrow$ 0,97 m	265 lm	3 W	EAN 4000870 702086  <b>702.08</b>
$\leftrightarrow$ 3 m	800 lm	7,5 W	EAN 4000870 705926  <b>705.92</b>

 daylight = 6.000 K



**Set**

$\leftrightarrow$ 1,5 m $\xrightarrow{\text{max.}}$ 4,8 m	405 lm	4,5 W	incl.  12 VA 	EAN 4000870 703182  <b>703.18</b>
$\leftrightarrow$ 3 m $\xrightarrow{\text{max.}}$ 7,5 m	810 lm	7,5 W	incl.  18 VA 	EAN 4000870 703212  <b>703.21</b>

**Strip**









$\leftrightarrow$ 0,97 m	270 lm	3 W	EAN 4000870 702093  <b>702.09</b>
$\leftrightarrow$ 3 m	810 lm	7,5 W	EAN 4000870 705933  <b>705.93</b>

 RGB



**Set**



$\leftrightarrow$ 1,5 m $\xrightarrow{\text{max.}}$ 3 m	275 lm	10 W	incl.  18 VA 	EAN 4000870 703199  <b>703.19</b>
$\leftrightarrow$ 3 m $\xrightarrow{\text{max.}}$ 5 m	550 lm	17,8 W	incl.  24 VA 	EAN 4000870 703229  <b>703.22</b>

**Strip**



$\leftrightarrow$ 0,98 m	184 lm	7 W	EAN 4000870 702109  <b>702.10</b>
$\leftrightarrow$ 3 m	550 lm	17,8 W	EAN 4000870 705940  <b>705.94</b>



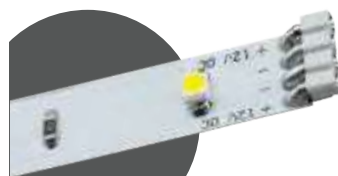

- ☞ Weiß ☐ Kunststoff
- ☞ Blanc ☐ Matière plastique
- ☞ Wit ☐ Kunststof

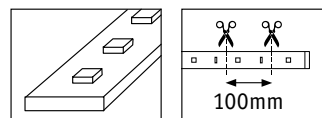

**YourLED Eco Comfort Set Touch**

230/12V



**YourLED Eco Comfort Set Touch**  
1m expanded max. 2m

incl. 1x2,4W  
3.000 K  
∠ 120°  
230/12V, incl. ⚡ 6 VA  
⊕3 mm ⊖10,5 mm ⊕1 m  
EAN 4000870 709542  
**709.54** 📦

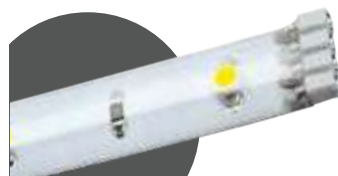

- ☞ Weiß ☐ Kunststoff
- ☞ Blanc ☐ Matière plastique
- ☞ Wit ☐ Kunststof

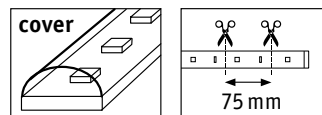

**YourLED Comfort Set Night**

230/12V



**YourLED Comfort Set Night**  
1m expanded max. 2m

incl. 1x3W  
273 lm, 3.000 K  
∠ 120°  
230/12V, incl. ⚡ 6 VA  
⊕3 mm ⊖975 mm ⊖10,5 mm ⊕1 m  
EAN 4000870 709559  
**709.55** 📦



- ☞ Schwarz ☐ Kunststoff
- ☞ Noir ☐ Matière plastique
- ☞ Zwart ☐ Kunststof

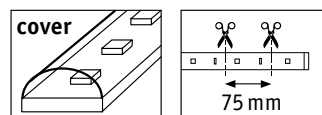

**YourLED Comfort Set Lights and Sound**

230/12V





**YourLED Comfort Set Lights and Sound**  
3m expanded max. 5m

incl. 1x17,8W  
∠ 120°  
1xCR 2025/3V  
230/12V, incl. ⚡ 18 VA  
⊕3 mm ⊖10,5 mm ⊕3 m  
EAN 4000870 709566  
**709.56** 📦

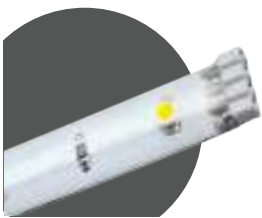



 Kunststoff  
 Matière plastique  
 Kunststof

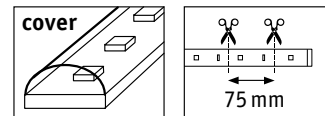

**YourLED IP44** 265 lm/m 39LED/m  $\updownarrow$  3 mm  $\curvearrowright$  10 mm 230/12V

 warm white = 3.000 K



**Set**







$\rightleftarrows$  3 m  $\xrightarrow{\text{max.}}$  7,5 m | 800 lm | 7,5 W | incl.  18 VA  EAN 4000870 705100  **705.10**

for  
RGB Color  
 $\square$  = 230–231



- ▶ RGB-Sound-Sensor - erfasst Töne und Musik und setzt diese in einen dynamischen Lichteindruck bei YourLED RGB Strips um - das Klasse Party Licht
- ▶ Geeignet zur Steuerung von farbigen RGB Strips
- ▶ Capteur de sons RGB - capte les tonalités et la musique puis les convertit en une impression lumineuse dynamique sur vos Strips RGB YourLED. - L'éclairage Party classe
- ▶ Convient au contrôle de rubans RGB de couleur
- ▶ RGB-soundsensor – detecteert tonen en muziek en zet deze bij YourLED RGB Strips om in een dynamische lichtindruk - de partylamp bij uitstek
- ▶ Geschikt voor de besturing van kleurige RGB strips



 Schwarz  Kunststoff  
 Noir  Matière plastique  
 Zwart  Kunststof

**RGB-Sound-Sensor**

max. 60 W  
 1xCR 2025/3V  
 DC 12 V  
 $\updownarrow$  22  $\rightleftarrows$  60  $\curvearrowright$  35 mm  
 EAN 4000870 709177  
**709.17** 

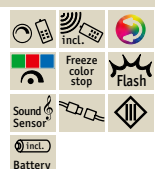

for  
RGB Color  
□ = 230–231

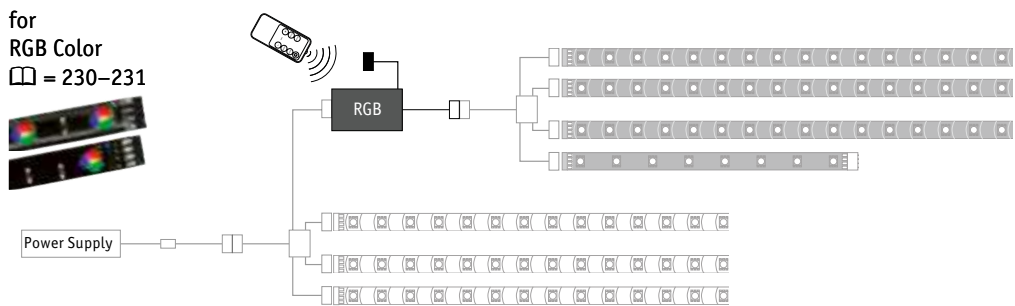

↳ Weiß □ Kunststoff  
↳ Blanc □ Matière plastique  
↳ Wit □ Kunststof

- ▶ Notwendig zur Ansteuerung von YourLED und YourLED ECO RGB-Streifen
- ▶ IR-Fernbedienung mit freier Wahl voreingestellter Farben sowie zur Feinjustierung der einzelnen Farbkanäle nach Bedarf. 4 Programme (Farbwechsel, Stroboskop,...)
- ▶ Stufenloses Dimmen
- ▶ Indispensable pour la commande de YourLED ECO et YourLED ECO RGB
- ▶ Télécommande avec couleurs pré-réglées au choix et réglage fin des canaux de couleur en fonction des besoins. 4 programmes (changement de couleurs/ stroboscope, etc.)
- ▶ Intensité variable en continu
- ▶ Vereist voor de besturing van YourLED en YourLED ECO RGB-strips
- ▶ IR-afstandsbediening met vrije keuze van voorinstelde kleuren alsook voor de justering van de afzonderlijke kleurkanalen naar behoefte. 4 programma's (kleurwissel, stroboscoop,...)
- ▶ Traploos dimmen



**RGB-Controller 12V DC**

max. 60 W  
1xCR 2025/3V  
DC 12 V  
∅22 ↔60 ↗35 mm  
EAN 4000870 702024  
**702.02**



for  
RGB Color  
□ = 230–231

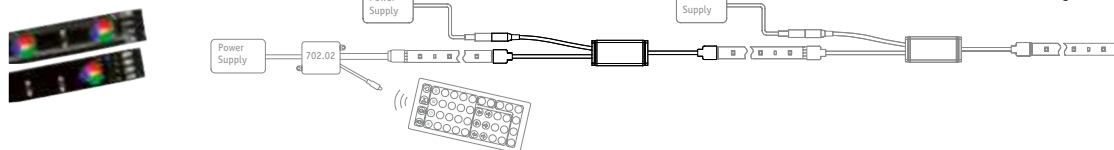

↳ Weiß □ Kunststoff  
↳ Blanc □ Matière plastique  
↳ Wit □ Kunststof

- ▶ Zur Verstärkung des Steuerungssignals vom YourLED RGB-Controller Art. 702.02.
- ▶ So lassen sich über eine Fernbedienung größere YourLED RGB- oder YourLED ECO RGB-Strip-Systeme synchron steuern.
- ▶ Über jeden Verstärker wird ein zusätzlicher Power Supply angeschlossen, um die Systemleistung zu erhöhen
- ▶ Permet d'amplifier le signal de commande de la commande YourLED RGB, art. 702.02.
- ▶ À l'aide d'une télécommande, il est possible de commander simultanément des systèmes de ruban YourLED ECO RGB ou YourLED de plus grande taille.
- ▶ Une alimentation électrique supplémentaire est branchée sur chaque amplificateur pour augmenter la puissance du système
- ▶ Voor versterking van het stuursignaal van YourLED RGB-regelaar art. 702.02.
- ▶ Zo kunnen met een afstandsbediening grotere YourLED of YourLED ECO RGB-stripsystemen synchron worden gestuurd.
- ▶ Via elke versterker wordt een aanvullende Power Supply aangesloten, om het systeemvermogen te verhogen



**RGB Amplifier**

max. 60 W  
DC 12 V  
∅8 ↔51 ↗27 mm  
EAN 4000870 709122  
**709.12**

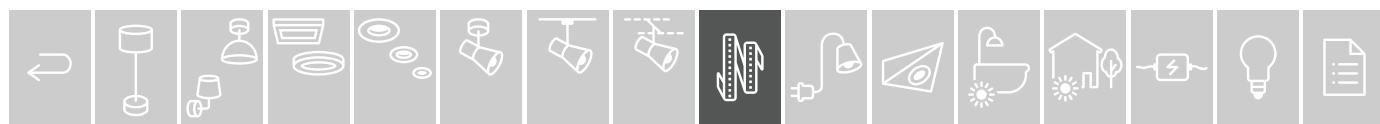

for  
Strip  
□□ = 230–233

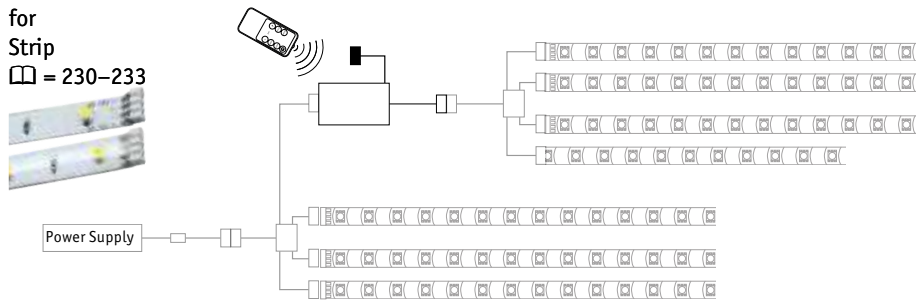

↳ Weiß □□ Kunststoff  
↳ Blanc □□ Matière plastique  
↳ Wit □□ Kunststof

- ▶ Zum Schalten oder Dimmen einfarbiger YourLED oder YourLED ECO Strips
- ▶ Der Controller mit Fernbedienung bietet Komfort und begeistert durch angenehmes dimmbares Stimmungslicht
- ▶ Pour commuter ou varier l'intensité des rubans monocouleurs YourLED ou YourLED ECO Stripes
- ▶ Avec sa télécommande, le contrôleur offre un grand confort d'utilisation et enthousiasme par son agréable éclairage d'ambiance à intensité variable.
- ▶ Voor het schakelen of dimmen van eenkleurige YourLED of YourLED ECO Stripes
- ▶ De controller met afstandsbediening biedt comfort en overtuigt door aangename dimbare sfeerverlichting.



#### Dimm/Switch Controller IR

max. 60 W  
1xCR 2025/3V  
DC 12 V  
⌀22 ↔63 ↗35 mm  
EAN 4000870 704615  
**704.61**



for  
Strip  
□□ = 230–233

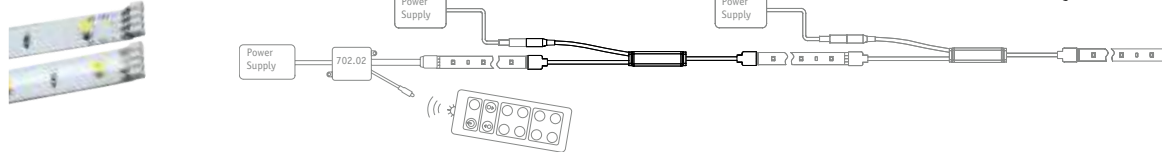

↳ Weiß □□ Kunststoff  
↳ Blanc □□ Matière plastique  
↳ Wit □□ Kunststof

- ▶ Zur Verstärkung des Steuerungssignals vom YourLED Dimm/Schalt-Controller Art. 704.61
- ▶ So lassen sich über eine Fernbedienung größere einfarbige YourLED oder YourLED ECO Strip-Systeme synchron dimmen oder schalten
- ▶ Über jeden Verstärker wird ein zusätzlicher Power Supply angeschlossen, um die Systemleistung zu erhöhen
- ▶ Permet d'amplifier le signal de commande du contrôleur de variation et de commutation YourLED, réf. 704.61
- ▶ Avec la télécommande, vous pouvez simultanément commuter ou varier l'intensité des systèmes de ruban YourLED ou YourLED ECO de plus grande taille
- ▶ Une alimentation électrique supplémentaire est branchée sur chaque amplificateur pour augmenter la puissance du système
- ▶ Ter versterking van het stuursignaal van de YourLED dim/schakel-controller art. 704.61
- ▶ Zo kunnen grotere eenkleurige YourLED of YourLED ECO Stripe-systemen synchroon worden gedimd of geschakeld met een afstandsbediening
- ▶ Via elke versterker wordt een aanvullende Power Supply aangesloten, om het systeemvermogen te verhogen



#### Mono Color Amplifier

max. 60 W  
DC 12 V  
⌀8 ↔50 ↗15 mm  
EAN 4000870 709115  
**709.11**







**Sensor**  
 10°  
 50-10mm  
 on/off

↳ Weiß Kunststoff  
 ↳ Blanc Matière plastique  
 ↳ Wit Kunststof

- ▶ Näherungsschalter für die An-/Aus-Schaltung der LED-Strips und anderer Produkte
- ▶ Max. 75 W (magnetische Trafos)
- ▶ Max. 60 W (elektronische Last)
- ▶ Max. 250 W (Glühlampen)

- ▶ Interrupteur de proximité Marche/Arrêt des rubans LED et autres produits
- ▶ Max. 75 W (transformateurs magnétiques)
- ▶ Max. 60 W (charge électronique)
- ▶ Max. 250 W (ampoules à incandescence)

- ▶ Naderingsschakelaar voor het in-/uitschakelen van de LED-stripes en andere producten
- ▶ Max. 75 W (magnetische trafo's)
- ▶ Max. 60 W (elektronische last)
- ▶ Max. 250 W (gloeilampen)



**PIR-Sensor 230V**

max. 60 W  
 230V  
 ⚡19 ⚡17,5 ⚡85 ⚡36 mm  
 EAN 4000870 704516  
**704.51**



for  
 Strip  
 □ = 230-233

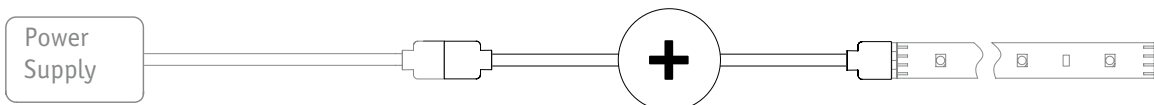
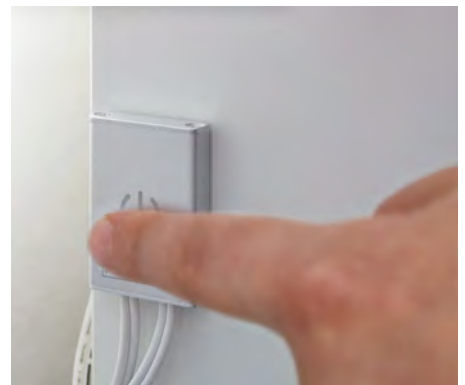

**Sensor**  
 120°  
 0,5-5m  
 5s-60s



↳ Weiß Kunststoff  
 ↳ Blanc Matière plastique  
 ↳ Wit Kunststof

**IR-Sensor**

max. 60 W  
 DC 12V  
 ⚡18 ⚡50 ⚡36 mm  
 EAN 4000870 707265  
**707.26**



↳ Weiß Kunststoff  
 ↳ Blanc Matière plastique  
 ↳ Wit Kunststof

**On/Off Switch**

max. 60 W  
 DC 12V  
 ⚡15 ⚡60 ⚡26 mm  
 EAN 4000870 707272  
**707.27**



- ▶ Schaltet bei Bewegung und Dunkelheit ein
- ▶ Leuchtdauer von 30 sec.–10 min. einstellbar
- ▶ Max. 60W
- ▶ Geeignet zur Steuerung von einfarbigen Strips 3000K, 4000K, 6000K

- ▶ Activé en cas de mouvement et dans l'obscurité
- ▶ Durée d'éclairage réglables de 30 s à au moins. 10 min
- ▶ Max. 60W
- ▶ Convient au contrôle de rubans monochromes 3000 K, 4000 K, 6000 K

- ▶ Schakelt bij beweging en duisternis in
- ▶ Verlichtingstijd instelbaar 30 sec. tot minimum 10 min.
- ▶ Max. 60W
- ▶ Geschikt voor de besturing van eenkleurige strips 3000K, 4000K, 6000K



<10 Lux  
100°  
0-5m  
30 s-10 min



- 👉 Silber 📦 Kunststoff
- 👉 Argent 📦 Matière plastique
- 👉 Zilver 📦 Kunststof

#### YourLED Night PIR Sensor

max. 60W  
DC 12V  
⌀31 ↔48 ⚙36 mm  
EAN 4000870 709610  
**709.61** 📦



- ▶ Schaltet bei Bewegung und Dunkelheit ein
- ▶ Leuchtdauer von 30 sec.–10 min. einstellbar
- ▶ Max. 60W
- ▶ Geeignet zur Steuerung von einfarbigen Strips 3000K, 4000K, 6000K

- ▶ Activé en cas de mouvement et dans l'obscurité
- ▶ Durée d'éclairage réglables de 30 s à au moins. 10 min
- ▶ Max. 60W
- ▶ Convient au contrôle de rubans monochromes 3000 K, 4000 K, 6000 K

- ▶ Schakelt bij beweging en duisternis in
- ▶ Verlichtingstijd instelbaar 30 sec. tot minimum 10 min.
- ▶ Max. 60W
- ▶ Geschikt voor de besturing van eenkleurige strips 3000K, 4000K, 6000K

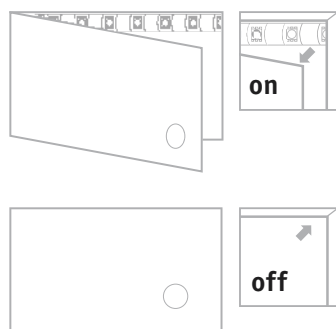

- 👉 Weiß 📦 Kunststoff
- 👉 Blanc 📦 Matière plastique
- 👉 Wit 📦 Kunststof

#### Magnetic Switch

max. 60W  
DC 12V  
⌀13,5 ↔40 ⚙20 mm  
EAN 4000870 709108  
**709.10** 📦



- ▶ Bequem schalten und dimmen durch Antippen
- ▶ Touchschalter zur modernen Steuerung von YourLED Strips
- ▶ Geeignet zur Steuerung von einfarbigen Strips 3000K, 4000K, 6000K
- ▶ Einfache Montage mit Klebepads
- ▶ Inkl. Memory Function

- ▶ Commutation et variation d'intensité confortables par simple effleurement
- ▶ Commutateur tactile pour un contrôle moderne des Strips YourLED
- ▶ Convient au contrôle de rubans monochromes 3000 K, 4000 K, 6000 K
- ▶ Montage aisé grâce à des pastilles autocollantes
- ▶ Avec effet mémoire

- ▶ Comfortabel schakelen en dimmen door aantikken
- ▶ Touchschakelaar voor moderne besturing van YourLED Strips
- ▶ Geschikt voor de besturing van eenkleurige strips 3000K, 4000K, 6000K
- ▶ Eenvoudige montage met hechtpads
- ▶ Incl. memory effect



- 👉 Silber 📦 Kunststoff
- 👉 Argent 📦 Matière plastique
- 👉 Zilver 📦 Kunststof

#### Touch Switch

max. 60W  
DC 12V  
⌀8,5 ↔43 ⚙30 mm  
EAN 4000870 709139  
**709.13** 📦





- ▶ Mini-Schalter und Dimmer zur praktischen Steuerung von YourLED Strips
- ▶ Geeignet zur Steuerung von einfarbigen Strips 3000K, 4000K, 6000K

- ▶ Mini-commutateur pour le contrôle pratique des Strips YourLED
- ▶ Convient au contrôle de rubans monochromes 3000 K, 4000 K, 6000 K

- ▶ Minischakelaar voor praktische besturing van YourLED Strips
- ▶ Geschikt voor de besturing van eenkleurige strips 3000K, 4000K, 6000K

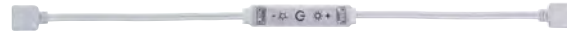
**Cord Switch**

max. 60 W  
DC 12 V  
⇄5,5 ⇄32 ⇄12 mm  
EAN 4000870 709146  
**709.14**

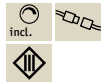

- ▶ Weiß ▣ Kunststoff
- ▶ Blanc ▣ Matière plastique
- ▶ Wit ▣ Kunststof

- ▶ Dämmerungsschalter zur tageslichtabhängigen Steuerung von YourLED Strips - schafft Komfort und Sicherheit
- ▶ Geeignet zur Steuerung von einfarbigen Strips 3000K, 4000K, 6000K
- ▶ Sensibilität fest definiert (<20Lux = Licht an)
- ▶ Einfache Montage mit Klebepads

- ▶ Interrupteur crépusculaire pour la commande de YourLED asservie à la lumière du jour - Crée confort et de sécurité
- ▶ Convient au contrôle de rubans monochromes 3000 K, 4000 K, 6000 K
- ▶ Sensibilité fixe (< 20Lux = lumière allumée)
- ▶ Montage aisé grâce à des pastilles autocollantes

- ▶ Schemerschakelaar voor daglichtafhankelijke besturing van YourLED Strips, zorgt voor comfort en veiligheid
- ▶ Geschikt voor de besturing van eenkleurige strips 3000K, 4000K, 6000K
- ▶ Gevoeligheid vast ingesteld (<20 lux = licht aan)
- ▶ Eenvoudige montage met hecht pads

**Twilight Sensor**

max. 60 W  
DC 12 V  
⇄8,5 ⇄43 ⇄30 mm  
EAN 4000870 709153  
**709.15**



- ▶ Silber ▣ Kunststoff
- ▶ Argent ▣ Matière plastique
- ▶ Zilver ▣ Kunststof

- ▶ Näherungsschalter schaltet ab 3 cm Ein oder Aus
- ▶ Touchschalter zur berührungslosen Steuerung von YourLED Strips
- ▶ Geeignet zur Steuerung von einfarbigen Strips 3000K, 4000K, 6000K
- ▶ Einfache Montage mit Klebepads

- ▶ Détecteur de proximité commutation M/A à partir de 3 cm
- ▶ Commutateur tactile pour la commande sans contact des Strips YourLED
- ▶ Convient au contrôle de rubans monochromes 3000 K, 4000 K, 6000 K
- ▶ Montage aisé grâce à des pastilles autocollantes

- ▶ Naderingsschakelaar schakelt vanaf 3cm Aan of Uit
- ▶ Touchschakelaar voor contactloze besturing van YourLED Strips
- ▶ Geschikt voor de besturing van eenkleurige strips 3000K, 4000K, 6000K
- ▶ Eenvoudige montage met hecht pads

**PIR-Sensor**

max. 60 W  
DC 12 V  
⇄8,5 ⇄43 ⇄30 mm  
EAN 4000870 709160  
**709.16**

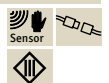

- ▶ Silber ▣ Kunststoff
- ▶ Argent ▣ Matière plastique
- ▶ Zilver ▣ Kunststof



for  
Strip  
□ = 230–233

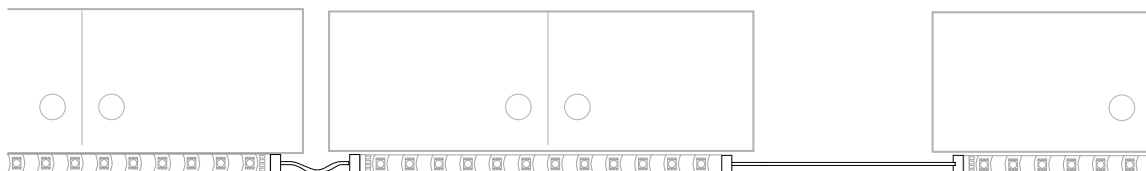

- 👉 Weiß 📦 Kunststoff
- 👉 Blanc 📦 Matière plastique
- 👉 Wit 📦 Kunststof



**Flex-Connector 10cm**

⇅5 mm ⇅13 mm ⇅0,1 m  
EAN 4000870 702154  
**702.15** 📦



**Flex-Connector 1m**

⇅13 mm ⇅5 mm ⇅1 m  
EAN 4000870 702048  
**702.04** 📦



**Flex-Connector 5m**

max. 60 W  
⇅13 mm ⇅5 mm ⇅5 m  
EAN 4000870 702512  
**702.51** 📦



- ▶ Geeignet für beschichtete und unbeschichtete YourLED Strips
- ▶ Passend für alle Paulmann Profile

- ▶ Adapté aux Strips YourLED gainés et non gainés
- ▶ Pour tous les profilés Paulmann

- ▶ Geschikt voor gecoate en niet-gecoate YourLED Strips
- ▶ Geschikt voor alle Paulmann profielen



**Universal YourLED Connector**

max. 60 W  
⇅7 ⇅100 ⇅16 mm  
EAN 4000870 709184  
**709.18** 📦



**Junction-Box**

max. 60 W  
⇅12 ⇅30 ⇅45 mm  
EAN 4000870 702031  
**702.03** 📦



- 👉 Weiß 📦 Kunststoff
- 👉 Blanc 📦 Matière plastique
- 👉 Wit 📦 Kunststof



**X-Connector**

max. 60 W  
⇅7 ⇅33 ⇅33 mm  
EAN 4000870 702826  
**702.82** 📦



- 👉 Weiß 📦 Kunststoff
- 👉 Blanc 📦 Matière plastique
- 👉 Wit 📦 Kunststof



**Edge-Connector 90° Pack**

max. 60 W  
⇅5 ⇅23 ⇅23 mm  
EAN 4000870 705995  
**705.99** 📦



- 👉 Weiß/Schwarz
- 👉 Blanc/Noir
- 👉 Wit/Zwart





- 👍 Weiß/Schwarz
- 👍 Blanc/Noir
- 👍 Wit/Zwart

**Edge-Connector Pack**

max. 60 W  
 ⚡12 ⚡17 ⚡13 mm  
 EAN 4000870 703342  
**703.34**

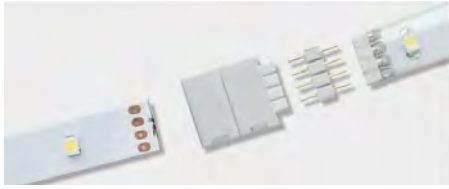

- 👍 Weiß 📦 Kunststoff
- 👍 Blanc 📦 Matière plastique
- 👍 Wit 📦 Kunststof

**ECO Clip-to-YourLED Connector Pack**

max. 60 W  
 ⚡6 ⚡13 ⚡18 mm  
 EAN 4000870 704905  
**704.90**



- 👍 Weiß 📦 Kunststoff
- 👍 Blanc 📦 Matière plastique
- 👍 Wit 📦 Kunststof

**ECO Clip Connector Pack**

⚡6 mm ⚡13,5 mm ⚡0,5 m  
 EAN 4000870 704882  
**704.88**



- 👍 Weiß 📦 Kunststoff
- 👍 Blanc 📦 Matière plastique
- 👍 Wit 📦 Kunststof

**ECO Clip-to-Clip Connector Pack**

max. 60 W  
 ⚡6 ⚡13,5 ⚡14 mm  
 EAN 4000870 704899  
**704.89**





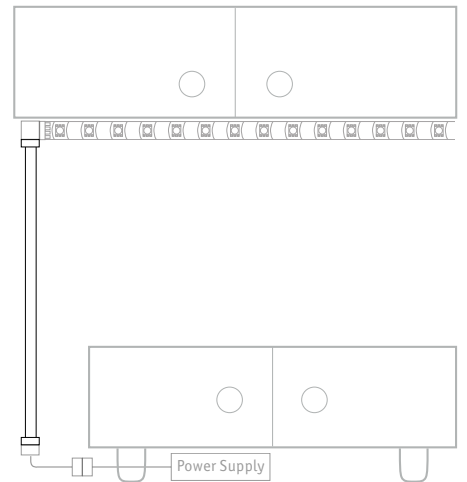



- 👍 Weiß 📦 Kunststoff
- 👍 Blanc 📦 Matière plastique
- 👍 Wit 📦 Kunststof



**Flat Connector**

max. 60 W  
 ⚡10 mm ⚡19 mm ⚡16,5 mm ⚡3 m  
 EAN 4000870 704868  
**704.86**



-  Weiß  Kunststoff
-  Blanc  Matière plastique
-  Wit  Kunststof

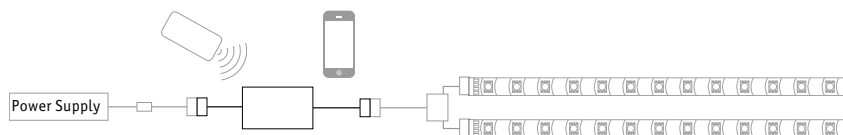

smart  
controllable  
 **Bluetooth®**



**YourLED Switch/Dimm Controller**

max. 60 W  
DC 12 V  
↑19 ↔39 ↗80 mm  
EAN 4000870 500385  
**500.38** 



**YourLED RGB Controller**

max. 60 W  
DC 12 V  
↑19 ↔39 ↗80 mm  
EAN 4000870 500392  
**500.39** 



smart  
controllable  
 **zigbee**



**YourLED Switch/Dimm Controller**

max. 60 W  
DC 12 V  
↑28 ↔38 ↗95 mm  
EAN 4000870 500484  
**500.48** 



**YourLED RGB Controller**

max. 60 W  
DC 12 V  
↑28 ↔38 ↗95 mm  
EAN 4000870 500491  
**500.49** 

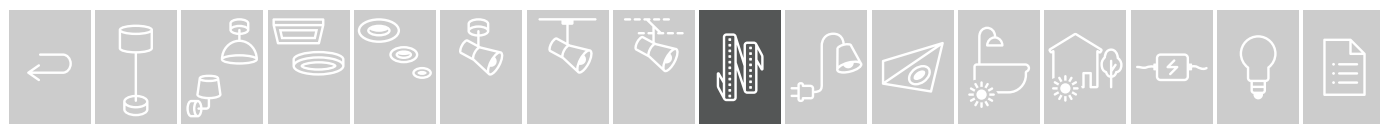



- 🔧 Weiß 🏠 Kunststoff
- 🔧 Blanc 🏠 Matière plastique
- 🔧 Wit 🏠 Kunststof

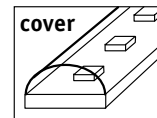

**Flaex LED**

-  RGB
-  smart controllable
-  Bluetooth®



**Flaex LED Strip Set 5m RGB**

incl. 1x18 W  
 536 lm  
 ∠ 120°  
 230/12 V, incl. - 24 VA  
 ⌀ 3 mm ⌀ 10,5 mm ⇄ 5 m  
 EAN 4000870 500057  
**500.05**



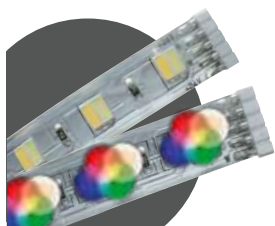

- ☞ Weiß ▣ Kunststoff
- ☞ Blanc ▣ Matière plastique
- ☞ Wit ▣ Kunststof

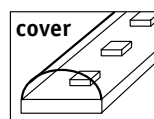

**Reflex LED**

-  tunable white
-  smart controllable
-  zigbee



**Reflex LED Strip Set 3m Tunable White**

incl. 1x20 W  
 1.650-1.740 lm, 3.000 - 6.500 K  
 <math>\sphericalangle 120^\circ</math>  
 230/24 V, incl. - 20 VA  
 <math>\varnothing 3\text{ mm}</math> <math>\varnothing 12,5\text{ mm}</math> <math>\leftrightarrow 3\text{ m}</math>  
 EAN 4000870 500804  
**500.80**



-  RGBW
-  smart controllable
-  zigbee



**Reflex LED Strip Set 3m RGBW**

incl. 1x20 W  
 750-780 lm, 3.000 K  
 <math>\sphericalangle 120^\circ</math>  
 230/24 V, incl. - 20 VA  
 <math>\varnothing 3\text{ mm}</math> <math>\varnothing 12,5\text{ mm}</math> <math>\leftrightarrow 3\text{ m}</math>  
 EAN 4000870 500811  
**500.81**

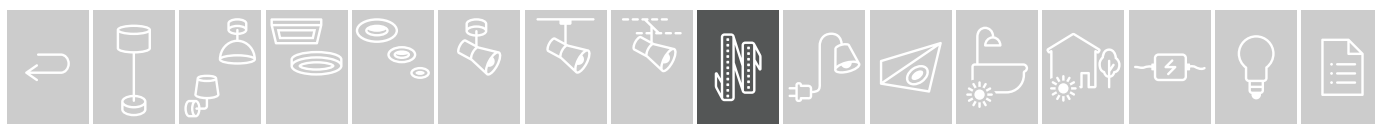



- ▶ Die FlexLED 3D Strips lassen sich in jede Richtung verlegen, als Kurve, Ecke oder Kante – alles ohne Zubehör
- ▶ Die Komplettssets inkl. Steuerung laden ein sofort loszulegen
- ▶ Les Strips FlexLED 3D se posent dans n'importe quelle direction, en courbe, dans les coins ou sur les arêtes – et tout cela sans accessoires.
- ▶ Les kits complets avec commande invitent à démarrer immédiatement.
- ▶ De FlexLED 3D strips zijn in elke richting te leggen, als bocht, hoek of rand – alles zonder toebehoren
- ▶ De complete sets incl. besturing laden en direct van start gaan



☞ Weiß ☞ Kunststoff  
☞ Blanc ☞ Matière plastique  
☞ Wit ☞ Kunststof

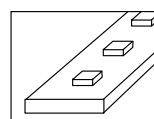

**FlexLED 3D**

320 lm/m    60 | 42 LED/m    3 mm x 8 | 10 mm    230/24V

● warm white = 3.000 K

- ▶ Die Strips können auf einen minimalen Winkel von 60° gebogen werden
- ▶ Inkl. Schnur-Dimm-Schalter
- ▶ Les Strips peuvent se plier à un angle minimal de 60°.
- ▶ Avec commutateur de variation à fil
- ▶ De strips kunnen gebogen worden tot een minimale hoek van 60°
- ▶ Incl. snoerdimschakelaar

**Set**

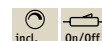

↔ 1,5 m		480 lm		5 W		incl. 6 VA		EAN 4000870 789612	<b>789.61</b>
↔ 3 m		960 lm		8,0 W		incl. 12 VA		EAN 4000870 789629	<b>789.62</b>
↔ 5 m		1.600 lm		10,5 W		incl. 12 VA		EAN 4000870 789636	<b>789.63</b>

● RGB

- ▶ Die Strips können auf einen minimalen Winkel von 90° gebogen werden
- ▶ Inkl. Fernbedienung
- ▶ Les Strips peuvent se plier à un angle minimal de 90°.
- ▶ De strips kunnen gebogen worden tot een minimale hoek van 90°.

**Set**



↔ 1,5 m		11 W		incl. 12 VA		EAN 4000870 789643	<b>789.64</b>
↔ 3 m		19 W		incl. 24 VA		EAN 4000870 789650	<b>789.65</b>
↔ 5 m		26 W		incl. 36 VA		EAN 4000870 789667	<b>789.66</b>



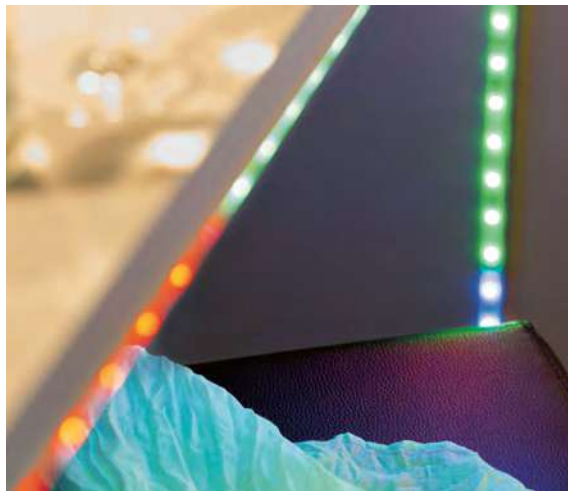

- ▶ Elektronisch kürzbares LED-Strip Set mit 164 Funktionen für vielfältige Lichteffekte
- ▶ Die digitale Steuerung erlaubt Farbmischungen in dynamischen Rhythmen
- ▶ Dimm- und schaltbar per Fernbedienung.
- ▶ Vom Strip-Ende her können Segmentweise je 3 LED abgeschaltet werden. Dadurch kann der Strip in passender Länge an unterschiedlichen Plätzen eingesetzt werden.
- ▶ Kit de ruban LED raccourcissable électroniquement et équipé de 164 fonctions pour créer de nombreux effets de lumière
- ▶ La commande numérique permet de mélanger les couleurs dans des rythmes dynamiques
- ▶ Variation de l'intensité et commutation avec télécommande.
- ▶ Vous pouvez désactiver les LED à partir de l'extrémité du ruban par groupe de 3. Le ruban peut ainsi être placé à différents endroits avec la longueur requise.
- ▶ Elektronisch inkortbare LED-Stripe set met 164 functies voor veelzijdige lichteffecten
- ▶ Met de digitale besturing zijn kleurmengingen in dynamische ritmes mogelijk
- ▶ Dim- en schakelbaar per afstandsbediening.
- ▶ Vanuit het Stripe-uiteinde kunnen segmentgewijs telkens 3 LED's worden uitgeschakeld. Daardoor kan de Stripe in passende lengte op verschillende plaatsen worden ingezet.



Weiß Kunststoff  
 Blanc Matière plastique  
 Wit Kunststof

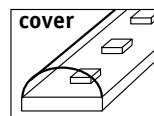

**Digital LED Strip Motion Color** 30 | 36 LED/m ⌀ 3 mm ⚡ 10 mm 230/12V

RGB

**Set**



↔ 3 m		165 lm		10 W		incl.  12 VA	EAN 4000870 704813 <b>704.81</b>
↔ 5 m		275 lm		16,5 W		incl.  18 VA	EAN 4000870 704806 <b>704.80</b>

RGBW – W = 3.000 K

**Set**



↔ 1,5 m		535 lm		5,5 W		incl.  12 VA	EAN 4000870 709092 <b>709.09</b>
↔ 3 m		1.070 lm		8 W		incl.  24 VA	EAN 4000870 706961 <b>706.96</b>
↔ 4,8 m		1.710 lm		10,5 W		incl.  24 VA	EAN 4000870 706978 <b>706.97</b>





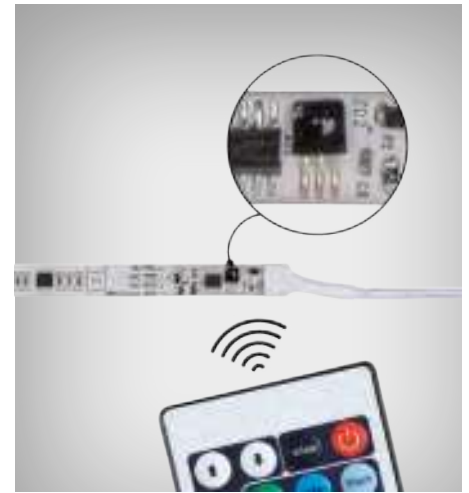

- |  |  |   |
|--|--|---|
| <ul style="list-style-type: none"> <li>▶ <b>Komplettsets:</b> Aufkleben, Stecker rein, Licht an.</li> <li>▶ 164 tolle Funktionen vom einfachen Farbwechsel bis zum Lauflicht bieten eine große Abwechslung</li> <li>▶ Einfach Steuerung über die enthaltene Fernbedienung</li> <li>▶ Ohne Empfängerbox – Der IR-Empfänger befindet sich platzsparend direkt auf dem Strip</li> </ul> | <ul style="list-style-type: none"> <li>▶ <b>Kits complets :</b> coller, brancher et la lumière s'allume.</li> <li>▶ Les 164 fonctions exceptionnelles, du simple changement de couleur au chenillard, offrent une grande diversité</li> <li>▶ Pilotage simple par la télécommande fournie</li> <li>▶ Sans boîte de réception – Le récepteur IR se trouve directement sur le Strip pour gagner de la place</li> </ul> | <ul style="list-style-type: none"> <li>▶ <b>Complete sets:</b> Opplakken, stekker insteken, licht aan.</li> <li>▶ 164 fantastische functies van simpele kleurwisseling tot looplicht bieden veel afwisseling</li> <li>▶ Eenvoudig bestuurbaar met de meegeleverde afstandsbediening</li> <li>▶ Zonder ontvangerbox – De IR-ontvanger bevindt zich direct op de Strip</li> </ul> |
|--|--|---|

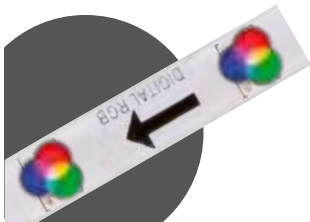

🖐️ Weiß 🏠 Kunststoff  
 🖐️ Blanc 🏠 Matière plastique  
 🖐️ Wit 🏠 Kunststof

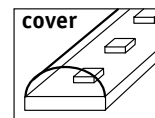

**SimpLED Motion** 65 lm/m 30LED/m ⬆️ 3 mm ⬆️ 8 mm 230/24 V

🌈 RGB

**Set**



↔️ <b>10,04 m</b>		650 lm		17 W		incl. 🔌 18 VA	📺	EAN 4000870 705155	🛒 <b>705.15</b>
↔️ <b>7,64 m</b>		494 lm		15 W		incl. 🔌 18 VA	📺	EAN 4000870 705148	🛒 <b>705.14</b>
↔️ <b>5,04 m</b>		325 lm		10 W		incl. 🔌 12 VA	📺	EAN 4000870 705131	🛒 <b>705.13</b>



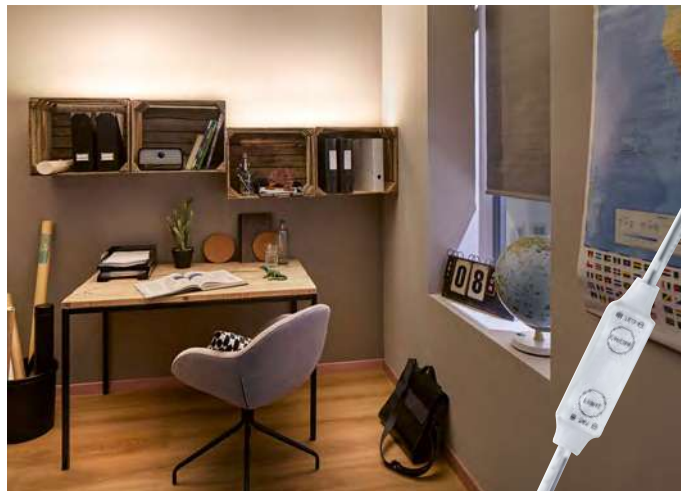

- ▶ Komplettsets: Aufkleben, Stecker rein, Licht an.
- ▶ Extrem leistungsstarke LED-Strips z.B. zur Raumbelichtung
- ▶ Steuerbar über den enthaltenen Schnur-Dimm-Schalter

- ▶ Kits complets : coller, brancher et la lumière s'allume.
- ▶ Strips LED extrêmement performants par ex. pour l'éclairage de pièces
- ▶ Pilotable par le commutateur-variateur de câble inclus

- ▶ Complete sets: Opplakken, stekker insteken, licht aan.
- ▶ Uiterst krachtige LED-strips bijv. voor ruimteverlichting
- ▶ Bestuurbaar met de bijgeleverde snoerdimschakelaar



Weiß Kunststoff  
 Blanc Matière plastique  
 Wit Kunststof

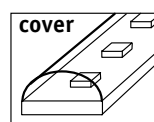

**SimpLED Power**

1100 lm/m

72 LED /m

⇅ 3 mm ⇅ 10 mm

230/24 V

warm white = 3.000 K

**Set**



⇅ 1,5 m		1.650 lm		17 W		incl.  24 VA		EAN 4000870 789551	<b>789.55</b>
⇅ 3 m		3.300 lm		33 W		incl.  48 VA		EAN 4000870 789568	<b>789.56</b>
⇅ 5 m		5.500 lm		50 W		incl.  60 VA		EAN 4000870 789575	<b>789.57</b>

neutral white = 4.000 K

**Set**



⇅ 1,5 m		1.650 lm		17 W		incl.  24 VA		EAN 4000870 789582	<b>789.58</b>
⇅ 3 m		3.300 lm		33 W		incl.  48 VA		EAN 4000870 789599	<b>789.59</b>
⇅ 5 m		5.500 lm		50 W		incl.  60 VA		EAN 4000870 789605	<b>789.60</b>





- ▶ Komplettssets: Aufkleben, Stecker rein, Licht an.
- ▶ Erhältlich in vielen Längen und Lichtfarben
- ▶ Die RGB Version ist steuerbar über die enthaltene Fernbedienung

- ▶ Kits complets : coller, brancher et la lumière s'allume.
- ▶ Disponible en plusieurs longueurs et températures de couleur
- ▶ La version RGB est pilotable par la télécommande incluse

- ▶ Complete sets: Opplakken, stekker insteken, licht aan.
- ▶ Verkrijgbaar in vele lengtes en lichtkleuren
- ▶ De RGB versie is bestuurbaar met de meegeleverde afstandsbediening



- 👉 Weiß 🏠 Metall/Kunststoff
- 👉 Blanc 🏠 Métal/Matière plastique
- 👉 Wit 🏠 Metaal/Kunststof

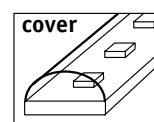

**SimpLED**

100-190 lm/m    30 | 60 LED/m    ⬆ 3 mm ⬆ 10 mm    230/12V

**RGB**

**Set**



↔ 5 m		505 lm		20 W		incl. - 24 VA	🔌	EAN 4000870 789780	🛒 <b>789.78</b>
↔ 7,5 m		760 lm		26 W		incl. - 36 VA	🔌	EAN 4000870 789797	🛒 <b>789.79</b>
↔ 10 m		1.010 lm		28 W		incl. - 36 VA	🔌	EAN 4000870 789803	🛒 <b>789.80</b>

**warm white = 3.000 K**

**Set**



↔ 5 m		1.500 lm		17 W		incl. - 18 VA	🔌	EAN 4000870 789728	🛒 <b>789.72</b>
↔ 7,5 m		2.250 lm		20 W		incl. - 24 VA	🔌	EAN 4000870 789735	🛒 <b>789.73</b>
↔ 10 m		3.000 lm		22 W		incl. - 36 VA	🔌	EAN 4000870 789742	🛒 <b>789.74</b>

**daylight = 6.500 K**

**Set**



↔ 5 m		1.550 lm		17 W		incl. - 18 VA	🔌	EAN 4000870 789759	🛒 <b>789.75</b>
↔ 7,5 m		2.325 lm		20 W		incl. - 24 VA	🔌	EAN 4000870 789766	🛒 <b>789.76</b>
↔ 10 m		3.100 lm		22 W		incl. - 36 VA	🔌	EAN 4000870 789773	🛒 <b>789.77</b>



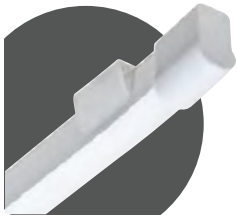

🖨️ Weiß 🏠 Kunststoff  
 🖨️ Blanc 🏠 Matière plastique  
 🖨️ Wit 🏠 Kunststof

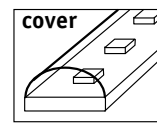

**SimpLED Outdoor new** 420 lm/m 40 LED/m ⇅ 15,5 mm ⇅ 8,5 mm 230/24V

🟡 warm white = 3.000 K



**Set**

⇅ 3 m		1.260 lm		12 W		incl. 🖨️ 18 VA	🖨️	EAN 4000870 789056	<b>789.05</b>
⇅ 5 m		2.100 lm		20 W		incl. 🖨️ 24 VA	🖨️	EAN 4000870 789063	<b>789.06</b>

🟢 daylight = 6.500 K



**Set**

⇅ 3 m		1.260 lm		12 W		incl. 🖨️ 18 VA	🖨️	EAN 4000870 789070	<b>789.07</b>
⇅ 5 m		2.100 lm		20 W		incl. 🖨️ 24 VA	🖨️	EAN 4000870 789087	<b>789.08</b>





- ▶ Allseitig ummantelte LED-Strips für die dekorative Außenbeleuchtung im Garten, am Hauseingang, unterm Dachsturz, in Feuchträumen und an vielen anderen Stellen (IP67 - tauchwassergeschützt).
- ▶ Plug'n'play: steckerfertiges Komplettsset für die einfache Verlegung
- ▶ Inkl. Trafo (IP64 - staubdicht und spritzwassergeschützt).
- ▶ Inkl. 1m Zuleitung - 5m Verlängerungsleitung als Zubehör erhältlich (IP65 - strahlwassergeschützt)
- ▶ LED-Strips sind alle 10cm kürzbar - Endkappe und Silikon Versiegelung inkl.
- ▶ Zur freien Verlegung oder Befestigung mit Kunststoffbügeln (inkl.)
- ▶ Nicht für den Einsatz im Umfeld aggressiver Chemikalien (Chlorwasser u.ä.)
- ▶ Rubans LED totalement gainées pour de l'éclairage extérieur décoratif dans votre jardin, devant l'entrée de la maison, sous la pente du toit, dans des pièces humides et dans pleins d'autres endroits (IP67 - étanche à l'immersion temporaire).
- ▶ Plug & Play : kit complet prêt à poser
- ▶ Transfo. inclus (IP64 - étanche à la poussière et aux éclaboussures).
- ▶ Alimentation de 1m inclus - Extension de 5m disponible comme accessoire (IP65 - Protection contre les jets d'eau directs)
- ▶ Les rubans LED sont raccourçissables tous les 10cm - caches de finition et embouts silicone inclus
- ▶ Pour une installation avec ou sans supports de fixation en plastique (inclus)
- ▶ Ne convient pas une utilisation dans un environnement comportant des produits chimiques (chlore...)
- ▶ Aan alle zijde bedekte LED-strips voor decoratieve buitenverlichting in de tuin, bij de huisingang, onder afdakkingen, in vochtige ruimtes en op vele andere plekken (IP67 - dompelwaterbeschermd).
- ▶ Plug'n'play: stekkerklare complete set voor eenvoudige montage
- ▶ Incl. trafo (IP64 - stofdicht en spatwaterdicht).
- ▶ Incl. 1m toevoerleiding - 5m verlengleiding als toebehoren verkrijgbaar (IP65 - spuitwaterdicht)
- ▶ LED-strips kunnen elke 10cm worden ingekort - eindkap en silicone verzegeling incl.
- ▶ Voor vrije montage of bevestiging met kunststofbeugels (incl.)
- ▶ Niet voor gebruik in de buurt van agressieve chemicaliën (chloorwater etc.)



☑ Weiß ☑ Kunststoff  
☑ Blanc ☑ Matière plastique  
☑ Wit ☑ Kunststof

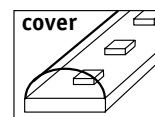

**WaterLED**

140 lm/m

13LED/m

4,5 mm 14 mm

230/12V

○ neutral white = 4.000 K

**Set**



↔ 3 m		420 lm		7 W		incl. ⚡ 7,2 VA	🔌	EAN 4000870 704196	🛒 704.19
↔ 5 m		700 lm		10,5 W		incl. ⚡ 12 VA	🔌	EAN 4000870 704189	🛒 704.18
↔ 7,5 m		1,000 lm		14 W		incl. ⚡ 18 VA	🔌	EAN 4000870 704172	🛒 704.17



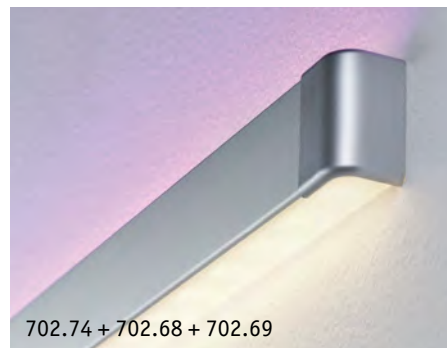

- ▶ Hochwertiges Doppel-T-Profil aus Aluminium mit eloxierter Oberfläche - für zweiseitige Lichteffekte
- ▶ Zur vielseitigen Beleuchtung mit LED-Strips
- ▶ Dekoratives Licht zur Inszenierung von Wohnräumen
- ▶ Optionaler Diffusor für gleichmäßige Lichtverteilung
- ▶ Für Wand-, Decken- oder Eckmontage
- ▶ Vielseitiges Zubehör für die Verlegung und Profilaabschlüsse
- ▶ Inkl. Kabelführung
- ▶ Positiver Kühleffekt für LED-Strips
- ▶ Erhältlich als Einzelkomponenten oder praktisches Set

- ▶ Profilé double T haut de gamme en aluminium anodisé – avec effet lumineux sur deux côtés
- ▶ Pour un éclairage diversifié avec Strips LED
- ▶ Éclairage décoratif pour une mise en valeur des pièces de séjour
- ▶ Diffuseur en option pour une répartition uniforme de la lumière
- ▶ Pour un montage sur mur, plafond ou en coin
- ▶ Nombreux embouts de profilé et accessoires pour la pose
- ▶ Guide câble inclus
- ▶ Effet de refroidissement positif pour les rubans LED
- ▶ Disponible sous forme de composants individuels ou combinés en un kit pratique

- ▶ Hoogwaardig dubbel-T-profiel van aluminium met geëloxeerd oppervlak – voor dubbelzijdige lichteffecten
- ▶ Voor veelzijdige verlichting met LED-strips
- ▶ Decoratieve verlichting voor het insceneren van woonruimtes
- ▶ Optionele diffusor voor gelijkmatige lichtverdeling
- ▶ Voor wand-, plafond- of hoekmontage
- ▶ Veelzijdig toebehoren voor montage en profielafsluitingen
- ▶ Incl. kabelgeleiding
- ▶ Positief koeleffect voor LED-strips
- ▶ Verkrijgbaar als afzonderlijke componenten of als praktische set



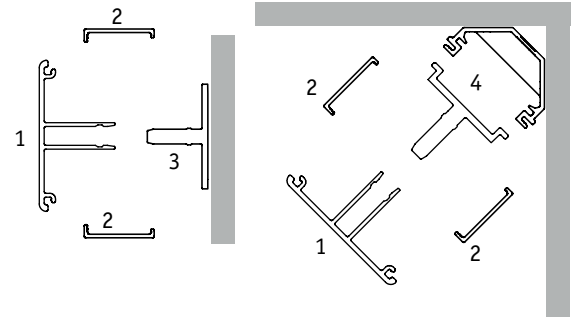
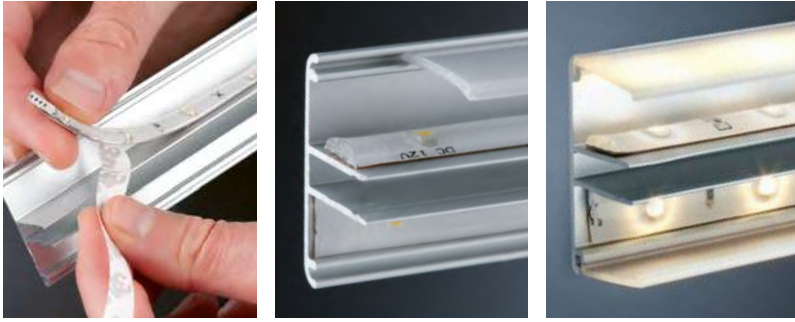

**Duo Profil Set incl. Clips & Diffusor**

⌀40 mm ⌀20 mm ⇄1 m  
EAN 4000870 705209  
**705.20**

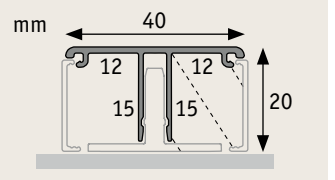

**Duo Profil Set incl. Clips & Diffusor**

⌀40 mm ⌀20 mm ⇄2 m  
EAN 4000870 705193  
**705.19**

- 🌀 Alu eloxiert 🗍 Alu
- 🌀 Alu anodisé 🗍 Alu
- 🌀 Alu geëloxeerd 🗍 Alu

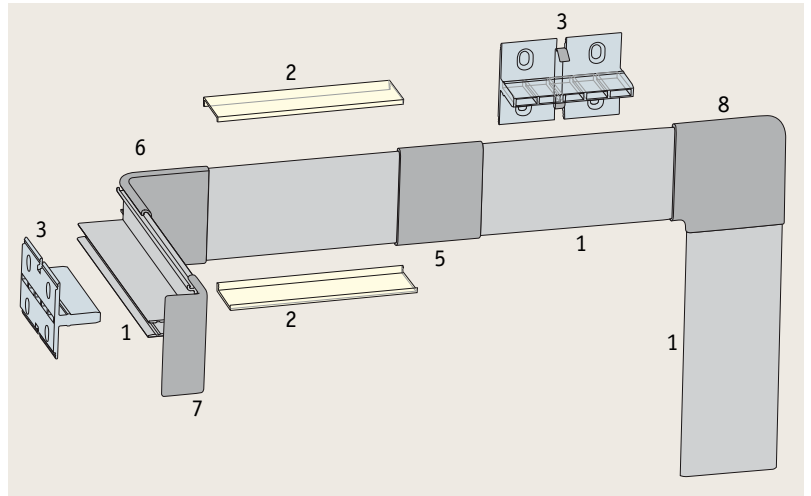

**Duo Profil 1m**

⌀40 mm ⌀20 mm ⇄1 m  
EAN 4000870 702680  
**702.68**



**Duo Profil 2m**

⌀40 mm ⌀20 mm ⇄2 m  
EAN 4000870 702673  
**702.67**

- 🌀 Alu 🗍 Alu
- 🌀 Alu 🗍 Alu
- 🌀 Alu 🗍 Alu

**Duo Profil Diffusor**

⌀4 mm ⌀20 mm ⇄2 m  
EAN 4000870 702697  
**702.69**

- 🌀 Satin 🗍 Kunststoff
- 🌀 Satiné 🗍 Matière plastique
- 🌀 Satijn 🗍 Kunststof

**Duo Profil Fixture**

⌀36 ⇄50 ⌀21 mm  
EAN 4000870 702758  
**702.75**

- 🌀 Transparent 🗍 Kunststoff
- 🌀 Transparent
- 🗍 Matière plastique
- 🌀 Transparant 🗍 Kunststof

**Duo Profil Clix**

⌀40 ⇄36 ⇄37 mm  
EAN 4000870 702215  
**702.21**

- 🌀 Transparent 🗍 Kunststoff
- 🌀 Transparent
- 🗍 Matière plastique
- 🌀 Transparant 🗍 Kunststof



**Duo Profil Cover**

⌀42 ⇄35 ⌀5 mm  
EAN 4000870 702703  
**702.70**

- 🌀 Alu matt 🗍 Kunststoff
- 🌀 Alu mat 🗍 Matière plastique
- 🌀 Alu mat 🗍 Kunststof



**Duo Profil Inside Corner**

⌀42 ⇄39 ⌀39 mm  
EAN 4000870 702727  
**702.72**

- 🌀 Alu matt 🗍 Kunststoff
- 🌀 Alu mat 🗍 Matière plastique
- 🌀 Alu mat 🗍 Kunststof

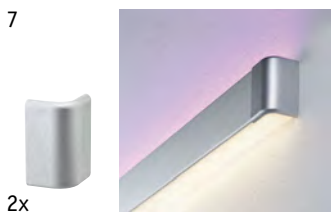

**Duo Profil End Cap**

⌀42 ⇄22 ⌀24 mm  
EAN 4000870 702741  
**702.74**

- 🌀 Alu matt 🗍 Kunststoff
- 🌀 Alu mat 🗍 Matière plastique
- 🌀 Alu mat 🗍 Kunststof



**Duo Profil 90° Corner**

⌀20 ⇄60 ⌀60 mm  
EAN 4000870 704530  
**704.53**

- 🌀 Alu matt 🗍 Kunststoff
- 🌀 Alu mat 🗍 Matière plastique
- 🌀 Alu mat 🗍 Kunststof









2013

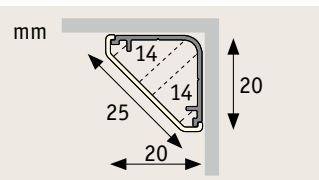
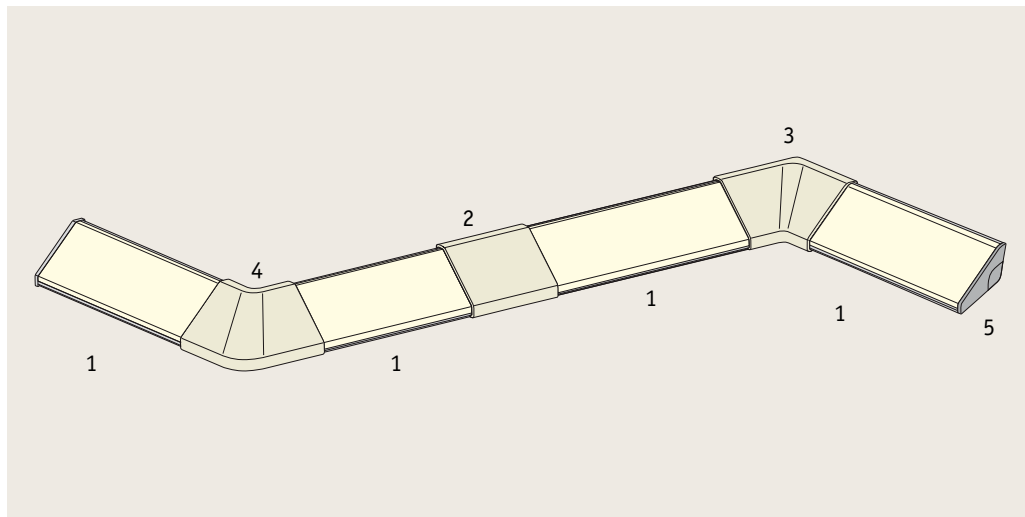
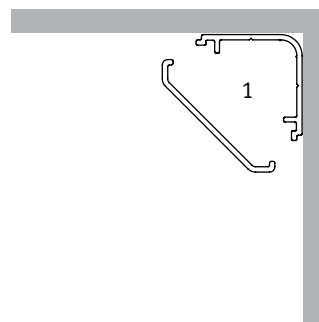

**Delta Profil 2m**  
 ↑20 mm ↗20 mm ↔2 m  
 EAN 4000870 702611  
**702.61**  
 ↳ Alu/Satin ▣ Alu/Kunststoff  
 ↳ Alu/Satiné ▣ Alu/Matière plastique  
 ↳ Alu/Satijn ▣ Alu/Kunststof

**Delta Profil 1m**  
 ↑20 mm ↗20 mm ↔1 m  
 EAN 4000870 702628  
**702.62**

**Delta Profil Cover**  
 ↑29 ↔35 ↗5 mm  
 EAN 4000870 702635  
**702.63**  
 ↳ Satin ▣ Kunststoff  
 ↳ Satiné ▣ Matière plastique  
 ↳ Satijn ▣ Kunststof

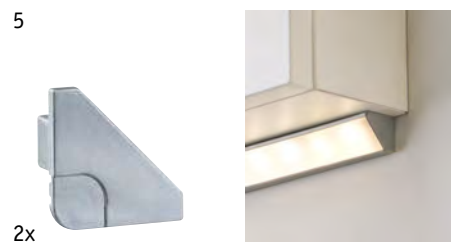

**Delta Profil Inside Corner**  
 ↑21 ↔35 ↗35 mm  
 EAN 4000870 702642  
**702.64**  
 ↳ Satin ▣ Kunststoff  
 ↳ Satiné ▣ Matière plastique  
 ↳ Satijn ▣ Kunststof

**Delta Profil Outside Corner**  
 ↑21 ↔35 ↗35 mm  
 EAN 4000870 702659  
**702.65**  
 ↳ Satin ▣ Kunststoff  
 ↳ Satiné ▣ Matière plastique  
 ↳ Satijn ▣ Kunststof

**Delta Profil End Cap**  
 ↑20 ↔8 ↗20 mm  
 EAN 4000870 702666  
**702.66**  
 ↳ Alu matt ▣ Kunststoff  
 ↳ Alu mat ▣ Matière plastique  
 ↳ Alu mat ▣ Kunststof

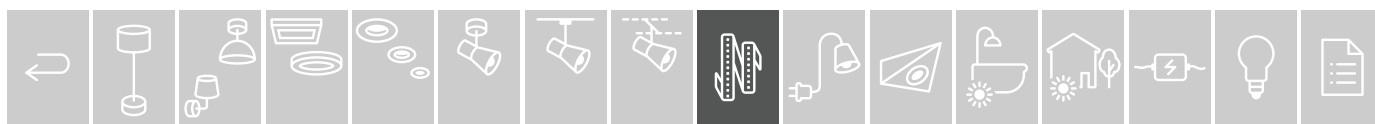



🔧 Alu/Satin 📏 Alu/Kunststoff  
🔧 Alu/Satiné 📏 Alu/Matière plastique  
🔧 Alu/Satijn 📏 Alu/Kunststof

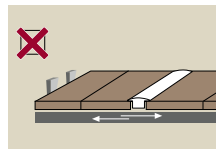
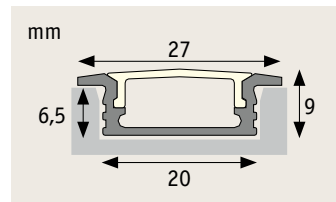
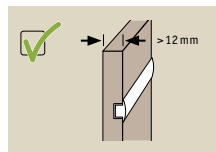
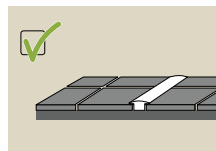
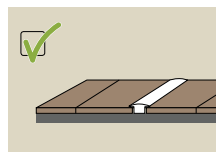

- ▶ Einbauprofil zur Beleuchtung mit LED-Strips schafft reizvolle Beleuchtungseffekte. Auch zum Einsatz als Orientierungs- oder Leitlicht geeignet.
- ▶ Hochwertiges Aluminium Profil mit trittfester Abdeckung (130 kg begehbar)
- ▶ Gleichmäßige Lichtverteilung
- ▶ Zum Einfräsen in Materialien ab 12 mm Stärke oder zum dauerhaften Verkleben in Laminat, Fliesen und Teppichboden.
- ▶ Inkl. Endkappen
- ▶ Nicht für schwimmend verlegtes Laminat geeignet

- ▶ Profilé encastrable avec de l'éclairage par rubans LED réalisant de ravissants effets lumineux. Idéal aussi pour de l'éclairage de balisage ou d'accentuation.
- ▶ Profil en aluminium de haute qualité avec un couvercle incassable (supporte une charge de 130 kg)
- ▶ Répartition uniforme de la lumière
- ▶ Pour entourer des matières d'au moins 12mm d'épaisseur ou pour coller durablement dans du parquet, du carrelage ou de la moquette.
- ▶ Embouts inclus
- ▶ Ne convient pas pour une utilisation dans du parquet flottant

- ▶ Inbouwprofiel ter verlichting met LED-strips voor inspirerende verlichtingseffecten. Ook voor gebruik als oriëntatie- of geleidingslicht.
- ▶ Hoogwaardig aluminium profiel met antislip afdekking (130 kg draagvermogen)
- ▶ Gelijkmatische lichtverdeling
- ▶ Voor het frezen in materiaal vanaf 12 mm dikte of voor permanente hechting in laminaat, tegel en tapijt.
- ▶ Incl. eindkappen
- ▶ Niet geschikt voor flexibel gelegd laminaat



**Floor Profil 1m**

↕9 ↔1.010 ↗27 mm  
 EAN 4000870 704103  
**704.10**

ALU	☀️
rost	☀️
frei	☀️
↓ Kg	
130	

**Floor Profil 2m**

↕9 ↔2.010 ↗27 mm  
 EAN 4000870 704097  
**704.09**

ALU	☀️
rost	☀️
frei	☀️
↓ Kg	
130	

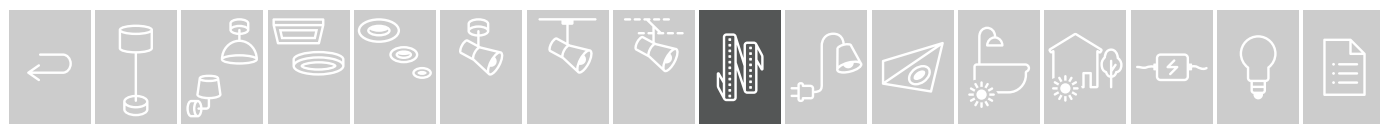



- 🔧 Grau 🏠 Kunststoff
- 🔧 Gris 🏠 Matière plastique
- 🔧 Grijs 🏠 Kunststof

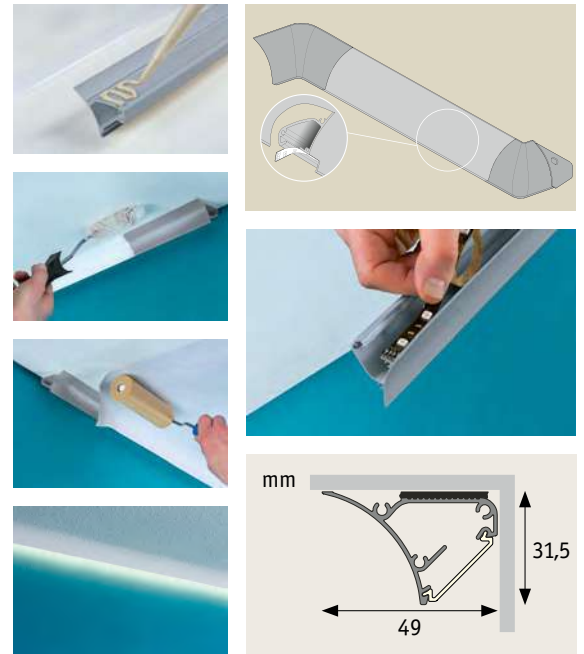

- |   |   |  |
|---|---|--|
| <ul style="list-style-type: none"> <li>▶ Dekoratives Deckenprofil zur indirekten Anstrahlung der Wand mit LED-Strips</li> <li>▶ Gleichmäßige Lichtverteilung</li> <li>▶ Lieferung inkl. Abschlusskappen für gerade Wandanschnitte</li> <li>▶ Innen- und Außenecken als Zubehör erhältlich</li> <li>▶ Außenecken können auch als Anfangs- und Endpunkt auf gerader Strecke verwendet werden.</li> <li>▶ Befestigung mittels handelsüblichen Bauklebern</li> <li>▶ Zur Verlegung von LED-Strips und Kabelverbindern.</li> </ul> | <ul style="list-style-type: none"> <li>▶ Profil décoratif pour le plafond pour un éclairage indirect des murs avec rubans LED.</li> <li>▶ Répartition uniforme de la lumière</li> <li>▶ Livré avec des caches</li> <li>▶ Caches pour coins intérieurs et extérieurs disponibles en tant qu'accessoires</li> <li>▶ Les coins extérieurs peuvent servir de de point de départ ou d'arrivée.</li> <li>▶ Fixation avec un mastic colle standard</li> <li>▶ Pour une pose avec rubans LED et câbles de connexion.</li> </ul> | <ul style="list-style-type: none"> <li>▶ Decoratief plafondprofiel voor indirecte verlichting van de wand met LED-strip.</li> <li>▶ Gelijkmatische lichtverdeling</li> <li>▶ Levering incl. afsluitkappen voor rechte wandmontage</li> <li>▶ Binnen- en buitenhoeken als toebehoren verkrijgbaar</li> <li>▶ Buitenhoeken kunnen ook als begin- en eindpunt op rechte delen worden gebruikt.</li> <li>▶ Bevestiging met gebruikelijke bouwlijm</li> <li>▶ Voor het leggen van LED-strips en kabelverbinders.</li> </ul> |
|---|---|--|



**Corner Profil 1m**  
 ⚙️31,5 mm ⚙️49 mm ⇄1 m  
 EAN 4000870 704400  
**704.40** 📦

**Corner Profil Inside Edge**  
 ⚙️31,5 ⇄59 ⚙️59 mm  
 EAN 4000870 704424  
**704.42** 📦

**Corner Profil Outside Edge**  
 ⚙️31,5 ⇄49 ⚙️49 mm  
 EAN 4000870 704417  
**704.41** 📦

**Corner Profil 2m**  
 ⚙️31,5 mm ⚙️49 mm ⇄2 m  
 EAN 4000870 704394  
**704.39** 📦

- 🔧 Grau 🏠 Kunststoff
- 🔧 Gris 🏠 Matière plastique
- 🔧 Grijs 🏠 Kunststof

- 🔧 Grau 🏠 Kunststoff
- 🔧 Gris 🏠 Matière plastique
- 🔧 Grijs 🏠 Kunststof



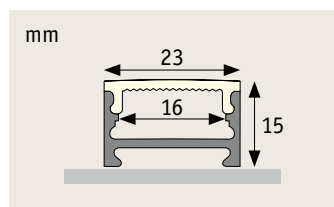
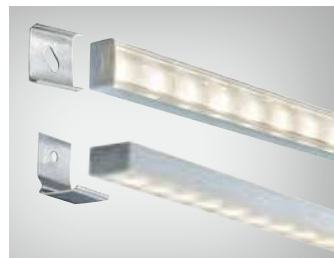

- ▶ Aufbauprofil für viele praktische Anwendungen
- ▶ Ausstrahlwinkel 120°
- ▶ Gleichmäßige Lichtverteilung
- ▶ Diffusor-Kante leuchtet
- ▶ Mit zwei Typen praktischer Halte-Clips für flache oder gekippte Montage
- ▶ Wandmontage möglich

- ▶ Profilé extrudé de nombreuses applications pratiques
- ▶ Angle de rayonnement 120°
- ▶ Répartition uniforme de la lumière
- ▶ L'arête du diffuseur s'éclaire
- ▶ Avec deux types de clip de fixation pratique pour un montage à plat ou incliné.
- ▶ Montage mural possible

- ▶ Opbouwprofiel voor veel praktische toepassingen
- ▶ Uitstraalhoek 120°
- ▶ Gelijkmatische lichtverdeling
- ▶ Diffusorrand verlicht
- ▶ Met twee types van praktische bevestigingsclips voor vlakke of gekantelde montage
- ▶ Wandmontage mogelijk



#### Square Profil 1m

15 mm 23 mm 1 m  
EAN 4000870 789049

**789.04 new**

- 🔧 Schwarz 田 Aluminium/Kunststoff
- 🔧 Noir 田 Aluminium/Matière plastique
- 🔧 Zwart 田 Aluminium/Kunststof

ALU  
rost  
frei

#### Square Profil 2m

15 mm 23 mm 2 m  
EAN 4000870 789032

**789.03 new**

ALU  
rost  
frei



#### Square Profil 1m

15 mm 23 mm 1 m  
EAN 4000870 708095

**708.09**

- 🔧 Alu/Satin 田 Alu/Kunststoff
- 🔧 Alu/Satiné 田 Alu/Matière plastique
- 🔧 Alu/Satijn 田 Alu/Kunststof

ALU  
rost  
frei

#### Square Profil 2m

15 mm 23 mm 2 m  
EAN 4000870 708101

**708.10**

ALU  
rost  
frei



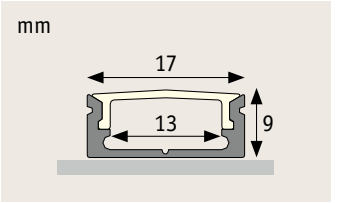
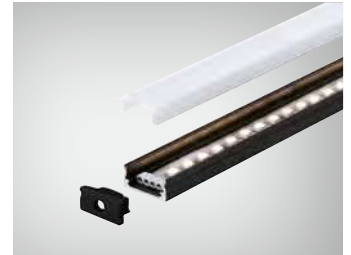

**Base Profil 1m**

⇅ 9 mm ⇅ 17 mm ⇅ 1 m  
EAN 4000870 789025

**789.02 new**

- 🔗 Schwarz ▣ Aluminium/Kunststoff
- 🔗 Noir ▣ Aluminium/Matière plastique
- 🔗 Zwart ▣ Aluminium/Kunststof

ALU  
rost  
frei

**Base Profil 2m**

⇅ 9 mm ⇅ 17 mm ⇅ 2 m  
EAN 4000870 789018

**789.01 new**

ALU  
rost  
frei



**Base Profil 1m**

⇅ 9 mm ⇅ 17 mm ⇅ 1 m  
EAN 4000870 705179

**705.17**

- 🔗 Alu eloxiert/Satin ▣ Aluminium/Kunststoff
- 🔗 Alu anodisé/Satiné ▣ Aluminium/Matière plastique
- 🔗 Alu geëloxeerd/Satijn ▣ Aluminium/Kunststof

ALU  
rost  
frei

**Base Profil 2m**

⇅ 9 mm ⇅ 17 mm ⇅ 2 m  
EAN 4000870 705186

**705.18**

ALU  
rost  
frei



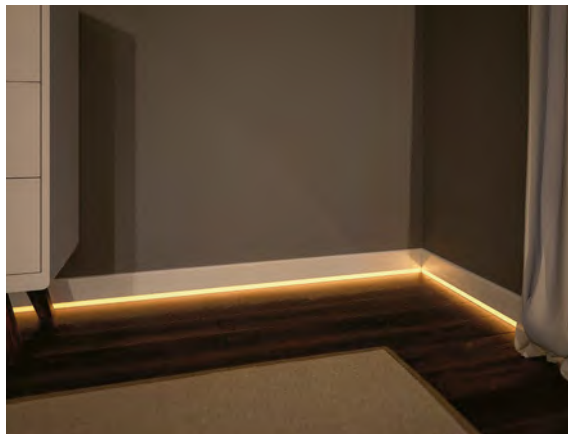

- ☞ Alu eloxiert/Satin ☒ Alu/Kunststoff
- ☞ Alu anodisé/Satiné ☒ Alu/Matière plastique
- ☞ Alu geëloxeerd/Satijn ☒ Alu/Kunststof

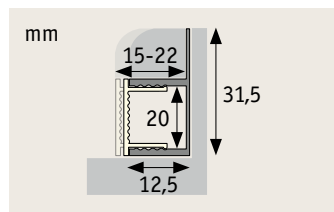

- ▶ Beleuchtetes Profil unter der Sockelleiste
- ▶ Optimal auf marktgängige Sockelleisten aus Holz und Kunststoff abgestimmt (alle gängigen Leistenstärken von 15-22mm werden unterstützt)
- ▶ Socle Profil ist auch bei schwimmend verlegtem Laminat einsetzbar
- ▶ Profilé éclairé sous la plinthe
- ▶ Convient parfaitement aux plinthes commercialisées en bois et synthétique (toutes les épaisseurs de plinthe de 15 à 22 mm sont compatibles)
- ▶ Le profilé Socle peut également être utilisé pour les planchers stratifiés flottants
- ▶ Verlicht profiel onder de plint
- ▶ Optimaal afgestemd op gangbare plinten van hout en kunststof (alle gangbare plindiktes van 15-22mm worden ondersteund)
- ▶ Socle Profil is ook bruikbaar bij flexibel gelegd laminaat



**Socle Profil 1m**

∩35 mm ∩12,5 mm ∩1 m  
 EAN 4000870 708620  
**708.62** 📦

**Socle Profil 2m**

∩35 mm ∩12,5 mm ∩2 m  
 EAN 4000870 708637  
**708.63** 📦



- ☞ Alu eloxiert/Satin ☒ Alu/Kunststoff
- ☞ Alu anodisé/Satiné ☒ Alu/Matière plastique
- ☞ Alu geëloxeerd/Satijn ☒ Alu/Kunststof

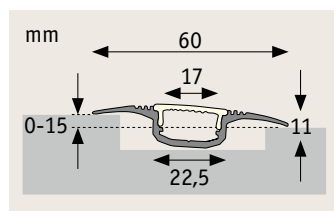

- ▶ Beleuchtetes Übergangprofil
- ▶ Beleuchteter Raumtrenner und Bereichsabgrenzung bei unterschiedlichen Fußbodenbelägen
- ▶ Auch bei schwimmend verlegtem Laminat anwendbar
- ▶ Sichere Schraubbefestigung
- ▶ Begehbar und rutschfest
- ▶ Profilé de jonction éclairé
- ▶ Séparateur de pièces éclairé et délimitation de zones en présence de différents revêtements de sol
- ▶ Peut également être utilisé pour les planchers stratifiés flottants
- ▶ Fixation sûre par vissage
- ▶ Praticable et antidérapant
- ▶ Verlicht overgangprofiel
- ▶ Verlichte ruimtescheider en afgrenzing van woongedeeltes bij verschillende vloerbedekkingen
- ▶ Ook bruikbaar bij zwevend gelegd laminaat
- ▶ Veilige schroefbevestiging
- ▶ Begaanbaar en slipvrij



**Step Profil 1m**



∩11 mm ∩60 mm ∩1 m  
 EAN 4000870 708552  
**708.55** 📦

**Step Profil 2m**

∩11 mm ∩60 mm ∩2 m  
 EAN 4000870 708569  
**708.56** 📦

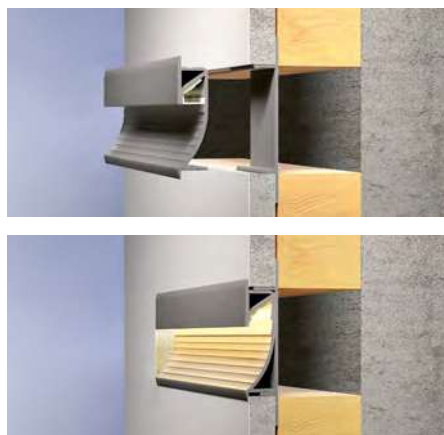



⚡ Alu eloxiert/Satin  Alu/  
Kunststoff  
 ⚡ Alu anodisé/Satiné  Alu/  
Matière plastique  
 ⚡ Alu geëloxeerd/Satijn  Alu/  
Kunststof

mm

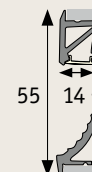

- ▶ Beleuchtetes Einbauprofil zwischen die Gipskarton-Platten
  - ▶ Ermöglicht modernes Orientierungslicht in Kombination mit architekturnaher Wandgestaltung
  - ▶ Ausgelegt für Trockenbau mit Standard-Gipskarton (12,5mm) und Ständerwerk
  - ▶ Wartungsfähig: das Profil kann bei Bedarf nachträglich von den Halterungen gelöst werden
  - ▶ Kabelmitführung wird unterstützt
- ▶ Profilé encastrable éclairé entre les plaques de plâtre
  - ▶ Offre un éclairage de balisage moderne et une structure murale conforme à l'architecture
  - ▶ Conçu pour la construction à sec avec des plaques de plâtre standard (12,5 mm) et une ossature
  - ▶ Entretien facile – le profilé peut être si nécessaire détaché ultérieurement des supports
  - ▶ Câblage pris en charge
- ▶ Verlicht inbouwprofiel tussen de gipsplaten
  - ▶ Maakt modern oriënteringslicht in combinatie met architectuurgebaseerd wanddesign mogelijk
  - ▶ Gemaakt voor droogbouw met standaard gipsplaten (12,5mm) en frames
  - ▶ Onderhoudsvriendelijk: het profiel kan indien gewenst achteraf worden losgemaakt van de houders
  - ▶ Kabelgeleiding wordt ondersteund



#### Cup Profil 1m

⌀55,1 mm ⌀14 mm ⇄1 m

EAN 4000870 708583

**708.58** 

#### Cup Profil 2m

⌀55,1 mm ⌀14 mm ⇄2 m

EAN 4000870 708590

**708.59** 





- ☞ Alu eloxiert ☒ Alu/Kunststoff
- ☞ Alu anodisé ☒ Alu/ Matière plastique
- ☞ Alu geëloxeerd ☒ Alu/ Kunststof

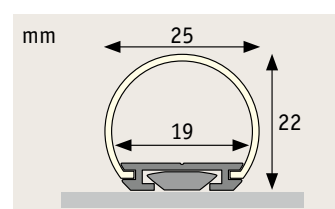
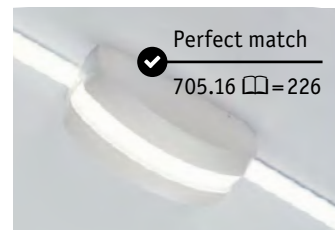

- ▶ Faszinierender Lichtaustritt durch 180° Abstrahlwinkel
- ▶ Fesselnder Effekt bei Kombination mit bunten MaxLED RGBW Strips
- ▶ Optimal als Decken- oder Wandleuchte geeignet
- ▶ Perfekt zur Kombination mit dem Shining Case (☐ = 226) geeignet.

- ▶ Diffusion lumineuse fascinante grâce à un angle de rayonnement de 180°
- ▶ Effet captivant en combinaison avec des Strips MaxLED RGBW colorés
- ▶ Idéal comme plafonnier ou applique
- ▶ Parfait en combinaison avec le Shining Case (☐ = 226).

- ▶ Fascinerende lichtuittreding door 180° stralingshoek
- ▶ Boeiend effect bij combinatie met kleurrijke MaxLED RGBW strips
- ▶ Optimaal geschikt als plafond- of wandlamp
- ▶ Perfect te combineren met de Shining Case (☐ = 226).



**Tube Profil 1m**

↕ 25 mm ø 25 mm ↗ 25 mm ↔ 1 m

EAN 4000870 705599

**705.59**

ALU  
rost  
frei

**Tube Profil 2m**

↕ 22 mm ø 25 mm ↗ 22 mm ↔ 2 m

EAN 4000870 705605

**705.60**

ALU  
rost  
frei

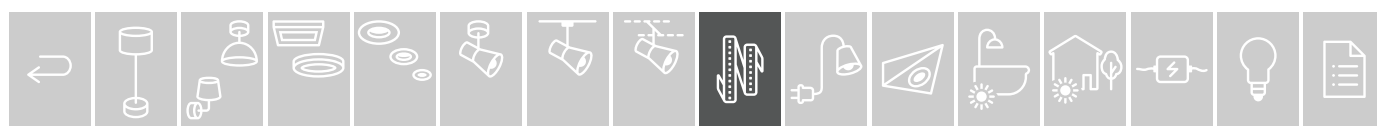







⚡ Blau/Grün/Orange/Pink 📦 Kunststoff  
 ⚡ Bleu/Vert/Orange/Rose  
 📦 Matière plastique  
 ⚡ Blauw/Groen/Oranje/Roze 📦 Kunststof

- ▶ Biegen und Falten –LED-Strips die Ihre Form beibehalten
  - ▶ Toller, homogener Neon-Lichteffekt
  - ▶ Neu: Mit beeindruckenden, steuerbaren RGB Farben (70557)
  - ▶ Mit USB-Stecker – Kompatibel mit Powerbanks, Laptops, Steckdosenadaptern, etc.
  - ▶ Inkl. 5 transparenter Halteclips, z.B. zur Wandmontage
- ▶ Cintrez et pliez - Strips LED à mémoire de forme
  - ▶ Super effet lumineux néon homogène
  - ▶ Nouveau : avec couleurs RGB contrôlables impressionnantes (70557)
  - ▶ Avec fiche USB – Compatible avec batteries externes, ordinateurs portables, adaptateurs secteur, etc.
  - ▶ Avec 5 clips de fixation transparents, par ex. pour une pose murale
- ▶ Buigen en vouwen – LED-strips die hun vorm behouden
  - ▶ Geweldig, homogeen neon-lichteffect
  - ▶ Nieuw: met indrukwekkende, bestuurbare RGB kleuren (70557)
  - ▶ Met USB-stekker - compatibel met powerbanks, laptops, stekkeradapters, etc.
  - ▶ Incl. 5 transparante klemmen, bijv. voor wandmontage

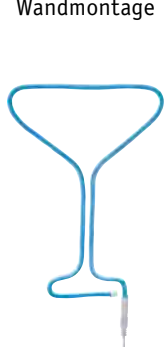

**Neon Colorflex USB Strip Blue**

incl. 1x4,5 W  
10 lm  
DC 5 V  
⌀12 mm ⌀6 mm ⇄1 m  
EAN 4000870 705643  
**705.64**



**Neon Colorflex USB Strip Orange**

incl. 1x4,5 W  
10 lm  
DC 5 V  
⌀12 mm ⌀6 mm ⇄1 m  
EAN 4000870 705629  
**705.62**



**Neon Colorflex USB Strip Green**

incl. 1x4,5 W  
10 lm  
DC 5 V  
⌀12 mm ⌀6 mm ⇄1 m  
EAN 4000870 705636  
**705.63**



**Neon Colorflex USB Strip Pink**

incl. 1x4,5 W  
10 lm  
DC 5 V  
⌀12 mm ⌀6 mm ⇄1 m  
EAN 4000870 705612  
**705.61**



**Neon Colorflex USB Stripe mixed box**

incl. 4x4,5 W  
4x10 lm  
DC 5 V  
⌀12 mm ⌀6 mm ⇄1 m  
EAN 4000870 705582  
**705.58**

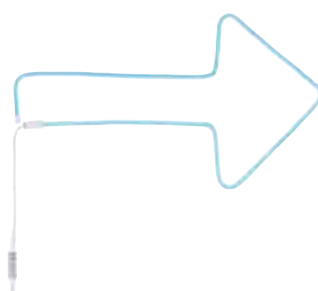

**Colorflex RGB**

incl. 1x5 W  
10 lm  
DC 5 V  
⇄85 mm ⌀14 mm ⇄1 m  
EAN 4000870 705575  
**705.57**





- ▣ elastisches Textil/Kunststoff
- ▣ textile élastique/Matière plastique
- ▣ elastisch textiel/Kunststof

- ▶ Bauchtasche inkl. LED-Licht
- ▶ Der Stretch-Stoff ist wetterbeständig und regenabweisend
- ▶ Die Tasche passt für gängige Smart-Phones
- ▶ Akku-Laufzeit ca. 3 Std.
- ▶ Ladezeit ca. 1 Std.

- ▶ Banane munie de LED
- ▶ Le tissu extensible résiste aux intempéries et est imperméable
- ▶ La poche peut contenir les smartphones les plus courants
- ▶ Autonomie batterie env. 3 heures
- ▶ Temps de charge env. 1 heure

- ▶ Buiktas incl. LED-licht
- ▶ De stretchstof is weerbestendig en waterafstotend
- ▶ De tas past voor standaard smartphones
- ▶ Laadtijd accu ca. 3 uur
- ▶ Laadtijd ca. 1 uur



**Waist bag red rechargeable**

incl. 1×0,4 W  
 DC 5 V  
 ⌀40 ⇔ 930 ↗20 mm  
 EAN 4000870 709689  
**709.68**



**Waist bag yellow rechargeable**

incl. 1×0,4 W  
 DC 5 V  
 ⌀40 ⇔ 930 ↗20 mm  
 EAN 4000870 709696  
**709.69**





- ☒ Kunststoff
- ☒ Matière plastique
- ☒ Kunststof



**USB-Light Stick 22cm**

incl. 1x0,5 W  
 50 lm, 6.500 K  
 DC 5 V  
 ⌀9 ⇄220 ↻18 mm  
 EAN 4000870 708866  
**708.86** 📄



**USB-Light Stick 22cm**

incl. 1x0,5 W  
 50 lm, 6.500 K  
 DC 5 V  
 ⌀9 ⇄220 ↻18 mm  
 EAN 4000870 708859  
**708.85** 📄

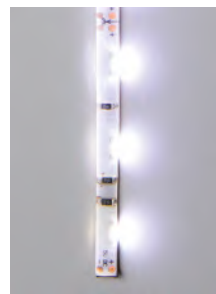

- ☒ Weiß ☒ Metall/Kunststoff
- ☒ Blanc ☒ Métal/Matière plastique
- ☒ Wit ☒ Metaal/Kunststof



**USB-Strip Daylight 30cm**

incl. 1x1,5 W  
 60 lm, 6.000 K  
 ⌀2,5 mm ⇄300 mm ↻5 mm ⇄0,3 m  
 EAN 4000870 704554  
**704.55** 📄



**USB-Strip Blue 30cm**

incl. 1x1,5 W  
 ⌀3 mm ⇄300 mm ↻5 mm ⇄0,3 m  
 EAN 4000870 704561  
**704.56** 📄



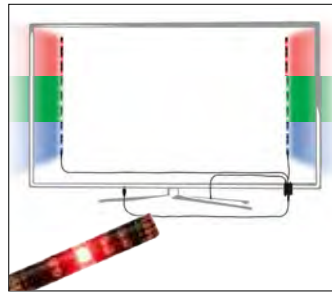

- ↳ Schwarz Metall/Kunststoff
- ↳ Noir Métal/Matière plastique
- ↳ Zwart Metaal/Kunststof



**USB-Strip RGB 2x50cm**

incl. 2x1,25 W  
 2x40 lm  
 <math>\sphericalangle 120^\circ</math>  
 1xCR 2025/3V  
 $\varnothing 3\text{ mm} \leftrightarrow 500\text{ mm} \varnothing 10\text{ mm} \leftrightarrow 0,5\text{ m}$   
 EAN 4000870 707067  
**707.06**



**USB-Strip Warm white 2x50cm**

incl. 2x2,2 W  
 2x100 lm, 3.000 K  
 $\varnothing 3\text{ mm} \leftrightarrow 500\text{ mm} \varnothing 10\text{ mm} \leftrightarrow 0,5\text{ m}$   
 EAN 4000870 707050  
**707.05**

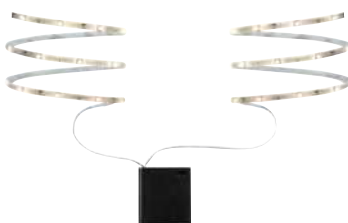
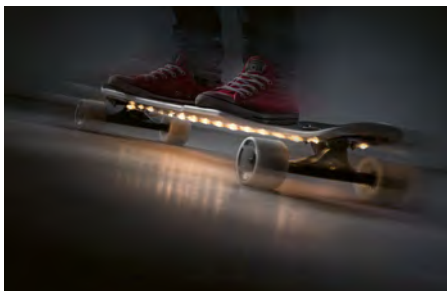

**Mobil Strip (4x1,5V AA excl.)**

incl. 2x0,9 W  
 2x95 lm, 2.700 K  
 4xAA/1,5 V (Mignon)  
 $\varnothing 3\text{ mm} \leftrightarrow 800\text{ mm} \varnothing 5\text{ mm} \leftrightarrow 0,8\text{ m}$   
 EAN 4000870 707012  
**707.01**

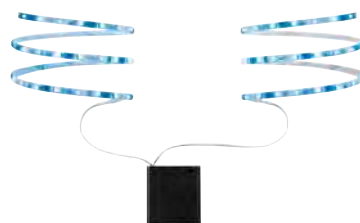

**Mobil Strip Blue (4x1,5V AA excl.)**

incl. 2x0,6 W  
 2x8 lm  
 4xAA/1,5 V (Mignon)  
 $\varnothing 3\text{ mm} \leftrightarrow 800\text{ mm} \varnothing 5\text{ mm} \leftrightarrow 0,8\text{ m}$   
 EAN 4000870 707029  
**707.02**



**Mobil Strip RGB (4x1,5V AA excl.)**

incl. 2x1,2 W  
 2x28 lm  
 4xAA/1,5 V (Mignon)  
 $\varnothing 3\text{ mm} \leftrightarrow 800\text{ mm} \varnothing 5\text{ mm} \leftrightarrow 0,8\text{ m}$   
 EAN 4000870 707005  
**707.00**



- ↳ Weiß Metall/Kunststoff
- ↳ Blanc Métal/Matière plastique
- ↳ Wit Metaal/Kunststof

- ↳ Weiß Metall/Kunststoff
- ↳ Blanc Métal/Matière plastique
- ↳ Wit Metaal/Kunststof

- ↳ Weiß Metall/Kunststoff
- ↳ Blanc Métal/Matière plastique
- ↳ Wit Metaal/Kunststof







**FlexLink**

incl. 1x4,5 W  
530 lm, 2.700 - 6.000 K  
2x18650 Akku/3,7V  
DC 5 V  
422 ⇄ 235 ↗ 236 mm  
EAN 4000870 954232  
**954.23**



 **tunable white**



Weiß Aluminium/  
Kunststoff/Silikon  
Blanc Aluminium/  
Matière plastique/Silicone  
Wit Aluminium/Kunststof/  
Silicon

**FlexLink**

incl. 1x4,5 W  
530 lm, 2.700 - 6.000 K  
2x18650 Akku/3,7V  
DC 5 V  
422 ⇄ 235 ↗ 236 mm  
EAN 4000870 954249  
**954.24**



 **tunable white**



Schwarz Aluminium/  
Kunststoff/Silikon  
Noir Aluminium/  
Matière plastique/Silicone  
Zwart Aluminium/  
Kunststof/Silicon

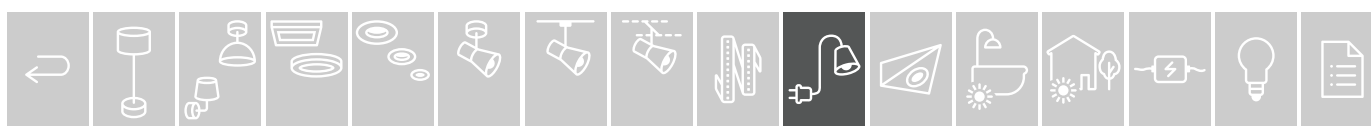



**Zed LED**

incl. 1x5 W  
630 lm, 3.000 K  
230 V  
475 ø160 mm  
EAN 4000870 702451

**702.45**

- 🔩 Eisen gebürstet 🏠 Metall
- 🔩 Acier brossé 🏠 Métal
- 🔩 Staal geborsteld 🏠 Metaal

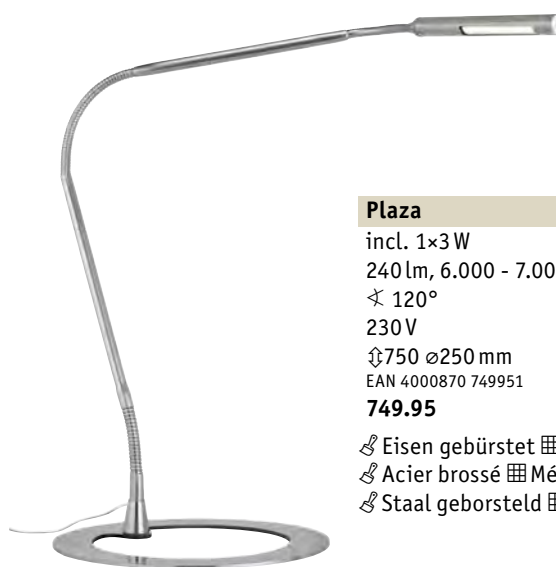

**Plaza**

incl. 1x3 W  
240 lm, 6.000 - 7.000 K  
120°  
230 V  
750 ø250 mm  
EAN 4000870 749951

**749.95**

- 🔩 Eisen gebürstet 🏠 Metall
- 🔩 Acier brossé 🏠 Métal
- 🔩 Staal geborsteld 🏠 Metaal

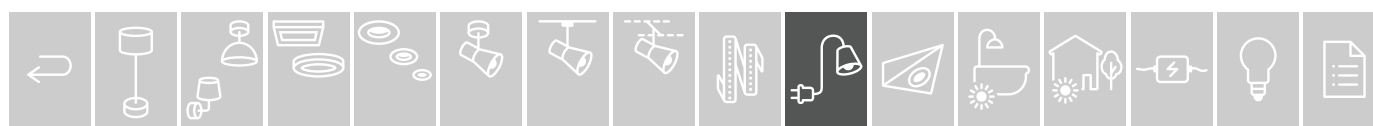





- 🔊 Weiß 📦 Kunststoff
- 🔊 Blanc 📦 Matière plastique
- 🔊 Wit 📦 Kunststof



**Viby**

incl. 1x0,7 W  
60 lm, 3.000 K  
3xAA-Akku/1,5V  
(Mignon)  
⌀110 ⇄110 ⤴37 mm  
EAN 4000870 924914  
**924.91** 📦



**Viby**

incl. 1x0,7 W  
56 lm, 3.000 K  
3xAA-Akku/1,5V  
(Mignon)  
ø120 ⤴40 mm  
EAN 4000870 924921  
**924.92** 📦



- 🔊 Weiß 📦 Kunststoff
- 🔊 Blanc 📦 Matière plastique
- 🔊 Wit 📦 Kunststof



**Esby**

incl. 1x0,016 W  
3 lm, 3.000 K  
230 V  
⌀80 ⇄80 ⤴58 mm  
EAN 4000870 924938  
**924.93** 📦



**Esby**

incl. 1x0,2 W  
30 lm, 3.000 K  
230 V  
ø90 ⤴70 mm  
EAN 4000870 924945  
**924.94** 📦



- 🔊 Weiß 📦 Kunststoff
- 🔊 Blanc 📦 Matière plastique
- 🔊 Wit 📦 Kunststof



**Horby**

incl. 1x0,4 W  
56 lm, 3.000 K  
230 V  
ø90 ⤴68 mm  
EAN 4000870 924952  
**924.95** 📦

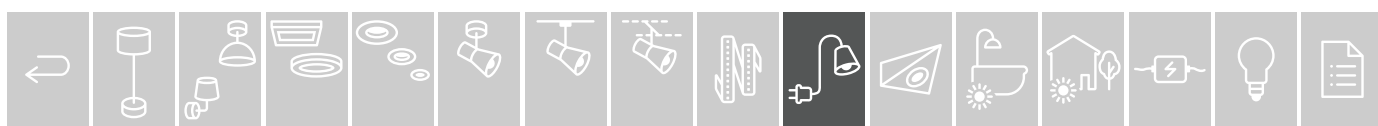









 Perfect match  
 □ = 407-408  
 416



**Vitis**

max. 20 W, E14  
 230 V  
 ⚡370 ø110 mm  
 EAN 4000870 954324

**954.32** 







-  Grau  Metall/Kunststoff
-  Gris  Métal/Matière plastique
-  Grijs  Metaal/Kunststof



**Vitis**

max. 20 W, E14  
 230 V  
 ⚡370 ø110 mm  
 EAN 4000870 954317

**954.31** 







-  Weiß  Metall/Kunststoff
-  Blanc  Métal/Matière plastique
-  Wit  Metaal/Kunststof



**Vitis**

max. 20 W, E14  
 230 V  
 ⚡370 ø110 mm  
 EAN 4000870 954300

**954.30** 







-  Schwarz  Metall/Kunststoff
-  Noir  Métal/Matière plastique
-  Zwart  Metaal/Kunststof



**Assistent Gryps**

max. 40 W, E14  
 230 V  
 ⚡150 ø60 ↔115 mm  
 EAN 4000870 998250

**998.25** 

-  Eisen gebürstet  Metall/Kunststoff
-  Acier brossé  Métal/Matière plastique
-  Staal geborsteld  Metaal/Kunststof





Perfect match  
 □ = 401-402  
 424



**Assistent Finja LED**

max. 35 W, GU10  
 230 V  
 ⌀330 ø51 ⇄115 mm  
 EAN 4000870 954263  
**954.26**



- 🔗 Chrom matt
- 🔗 Chrome mat
- 🔗 Chroom mat
- 🔗 Metall/Kunststoff
- 🔗 Métal/Matière plastique
- 🔗 Metaal/Kunststof



**Assistent Gesa LED**

max. 35 W, GU10  
 230 V  
 ⌀285 ø51 ⇄115 mm  
 EAN 4000870 954256  
**954.25**



- 🔗 Chrom matt
- 🔗 Chrome mat
- 🔗 Chroom mat
- 🔗 Metall/Kunststoff
- 🔗 Métal/Matière plastique
- 🔗 Metaal/Kunststof

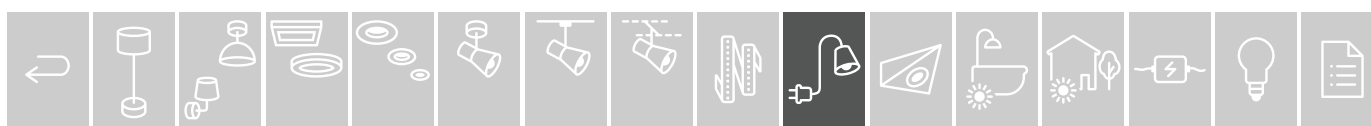



 **Perfect match**  
 □ = 407-408  
 416



**Junus**

max. 20 W, E14  
 230 V  
 ⌀390 ø110 mm  
 EAN 4000870 954294  
**954.29**



- ↳ Grau  Metall/Kunststoff
- ↳ Gris  Métal/Matière plastique
- ↳ Grijs  Metaal/Kunststof



**Junus**

max. 20 W, E14  
 230 V  
 ⌀390 ø110 mm  
 EAN 4000870 954287  
**954.28**



- ↳ Weiß  Metall/Kunststoff
- ↳ Blanc  Métal/Matière plastique
- ↳ Wit  Metaal/Kunststof



**Junus**

max. 20 W, E14  
 230 V  
 ⌀390 ø110 mm  
 EAN 4000870 954270  
**954.27**



- ↳ Schwarz  Metall/Kunststoff
- ↳ Noir  Métal/Matière plastique
- ↳ Zwart  Metaal/Kunststof



**Bento**

incl. 1×6 W  
600 lm, 3.000 K  
↙ 120°  
230 V  
⌀85 ⇄300 ↗120 mm  
EAN 4000870 955567

**955.56 new**

- ↳ Alu gebürstet ▣ Metall/Kunststoff
- ↳ Alu brossé ▣ Métal/Matière plastique
- ↳ Alu geborsteld ▣ Metaal/Kunststof

**Bento**

incl. 1×8,5 W  
900 lm, 3.000 K  
↙ 120°  
230 V  
⌀85 ⇄400 ↗120 mm  
EAN 4000870 955574

**955.57 new**

- ↳ Alu gebürstet ▣ Metall/Kunststoff
- ↳ Alu brossé ▣ Métal/Matière plastique
- ↳ Alu geborsteld ▣ Metaal/Kunststof

**Bento**

incl. 1×10 W  
1.050 lm, 3.000 K  
↙ 120°  
230 V  
⌀85 ⇄500 ↗120 mm  
EAN 4000870 955581

**955.58 new**

- ↳ Alu gebürstet ▣ Metall/Kunststoff
- ↳ Alu brossé ▣ Métal/Matière plastique
- ↳ Alu geborsteld ▣ Metaal/Kunststof

**Bento**

incl. 1×6 W  
600 lm, 3.000 K  
↙ 120°  
230 V  
⌀85 ⇄300 ↗120 mm  
EAN 4000870 955598

**955.59 new**

- ↳ Altmessing ▣ Metall/Kunststoff
- ↳ Laiton patiné ▣ Métal/Matière plastique
- ↳ oud messing ▣ Metaal/Kunststof

**Bento**

incl. 1×8,5 W  
900 lm, 3.000 K  
↙ 120°  
230 V  
⌀85 ⇄400 ↗120 mm  
EAN 4000870 955604

**955.60 new**

- ↳ Altmessing ▣ Metall/Kunststoff
- ↳ Laiton patiné ▣ Métal/Matière plastique
- ↳ oud messing ▣ Metaal/Kunststof

**Bento**

incl. 1×10 W  
1.050 lm, 3.000 K  
↙ 120°  
230 V  
⌀85 ⇄500 ↗120 mm  
EAN 4000870 955611

**955.61 new**

- ↳ Altmessing ▣ Metall/Kunststoff
- ↳ Laiton patiné ▣ Métal/Matière plastique
- ↳ oud messing ▣ Metaal/Kunststof

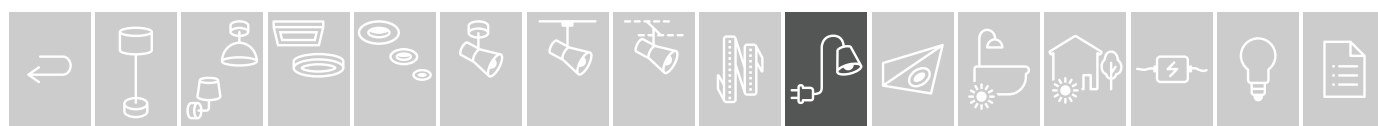

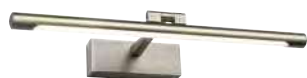

**Mingo**

incl. 1x9,5 W  
1.000 lm, 3.000 K  
↙ 120°  
230 V  
⌀50 ⇄415 ↗175 mm  
EAN 4000870 955628

**955.62 new**

- ↳ Altmessing ▣ Metall/Kunststoff
- ↳ Laiton patiné ▣ Métal/Matière plastique
- ↳ oud messing ▣ Metaal/Kunststof



**Mingo**

incl. 1x9,5 W  
1.000 lm, 3.000 K  
↙ 120°  
230 V  
⌀50 ⇄415 ↗175 mm  
EAN 4000870 955666

**955.66 new**

- ↳ Alu gebürstet ▣ Metall/Kunststoff
- ↳ Alu brossé ▣ Métal/Matière plastique
- ↳ Alu geborsteld ▣ Metaal/Kunststof



**Mingo**

incl. 1x9,5 W  
1.000 lm, 3.000 K  
↙ 120°  
230 V  
⌀50 ⇄415 ↗175 mm  
EAN 4000870 955642

**955.64 new**

- ↳ Schwarz ▣ Metall/Kunststoff
- ↳ Noir ▣ Métal/Matière plastique
- ↳ Zwart ▣ Metaal/Kunststof

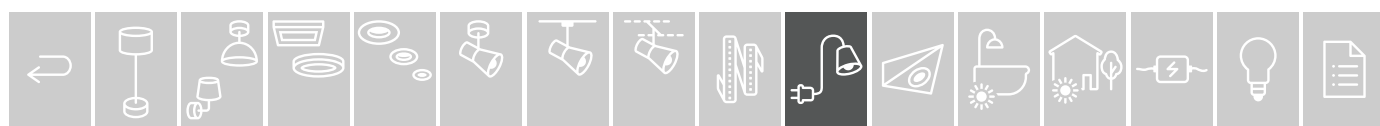

**Renan**

incl. 1x6 W  
600 lm, 3.000 K  
∠ 120°  
230 V  
∩125 ∩300 ∩210 mm  
EAN 4000870 955680

**955.68 new**

∩ Altmessing ∩ Metall/Acryl  
∩ Laiton patiné ∩ Métal/Acryl  
∩ oud messing ∩ Metaal/Acryl

**Renan**

incl. 1x9,5 W  
1.000 lm, 3.000 K  
∠ 120°  
230 V  
∩125 ∩400 ∩210 mm  
EAN 4000870 955697

**955.69 new**

∩ Altmessing ∩ Metall/Acryl  
∩ Laiton patiné ∩ Métal/Acryl  
∩ oud messing ∩ Metaal/Acryl

**Renan**

incl. 1x11 W  
1.250 lm, 3.000 K  
∠ 120°  
230 V  
∩125 ∩600 ∩210 mm  
EAN 4000870 955703

**955.70 new**

∩ Altmessing ∩ Metall/Acryl  
∩ Laiton patiné ∩ Métal/Acryl  
∩ oud messing ∩ Metaal/Acryl

**Renan**

incl. 1x6 W  
600 lm, 3.000 K  
∠ 120°  
230 V  
∩125 ∩300 ∩210 mm  
EAN 4000870 955710

**955.71 new**

∩ Alu gebürstet ∩ Metall/Acryl  
∩ Alu brossé ∩ Métal/Acryl  
∩ Alu geborsteld ∩ Metaal/Acryl

**Renan**

incl. 1x9,5 W  
1.000 lm, 3.000 K  
∠ 120°  
230 V  
∩125 ∩400 ∩210 mm  
EAN 4000870 955727

**955.72 new**

∩ Alu gebürstet ∩ Metall/Acryl  
∩ Alu brossé ∩ Métal/Acryl  
∩ Alu geborsteld ∩ Metaal/Acryl

**Renan**

incl. 1x11 W  
1.250 lm, 3.000 K  
∠ 120°  
230 V  
∩125 ∩600 ∩210 mm  
EAN 4000870 955734

**955.73 new**

∩ Alu gebürstet ∩ Metall/Acryl  
∩ Alu brossé ∩ Métal/Acryl  
∩ Alu geborsteld ∩ Metaal/Acryl

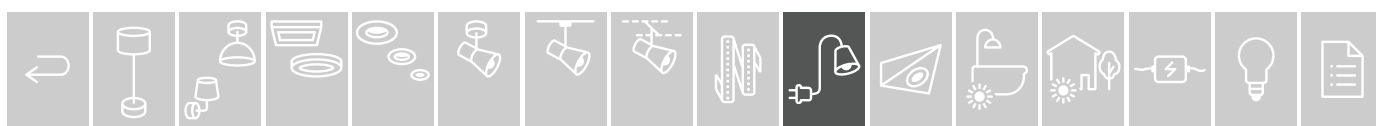



**Beam Fifty**

incl. 1×8 W  
850 lm, 2.700 K  
∠ 100°  
230 V  
⌀46 ⇄450 ↗190 mm  
EAN 4000870 998892

**998.89**

- 🔩 Chrom 📦 Metall
- 🔩 Chrome 📦 Métal
- 🔩 Chroom 📦 Metaal

**Beam Sixty**

incl. 1×11 W  
1,250 lm, 2.700 K  
∠ 100°  
230 V  
⌀46 ⇄585 ↗190 mm  
EAN 4000870 998908

**998.90**

- 🔩 Chrom 📦 Metall
- 🔩 Chrome 📦 Métal
- 🔩 Chroom 📦 Metaal



**Beam Thirty**

incl. 1×6 W  
630 lm, 2.700 K  
∠ 100°  
230 V  
⌀46 ⇄290 ↗190 mm  
EAN 4000870 998915

**998.91**

- 🔩 Weiß/Chrom 📦 Metall
- 🔩 Blanc/Chrome 📦 Métal
- 🔩 Wit/Chroom 📦 Metaal

**Beam Fifty**

incl. 1×8 W  
850 lm, 2.700 K  
∠ 100°  
230 V  
⌀46 ⇄450 ↗190 mm  
EAN 4000870 998922

**998.92**

- 🔩 Weiß/Chrom 📦 Metall
- 🔩 Blanc/Chrome 📦 Métal
- 🔩 Wit/Chroom 📦 Metaal

**Beam Sixty**

incl. 1×11 W  
1,250 lm, 2.700 K  
∠ 100°  
230 V  
⌀46 ⇄585 ↗190 mm  
EAN 4000870 998939

**998.93**

- 🔩 Weiß/Chrom 📦 Metall
- 🔩 Blanc/Chrome 📦 Métal
- 🔩 Wit/Chroom 📦 Metaal

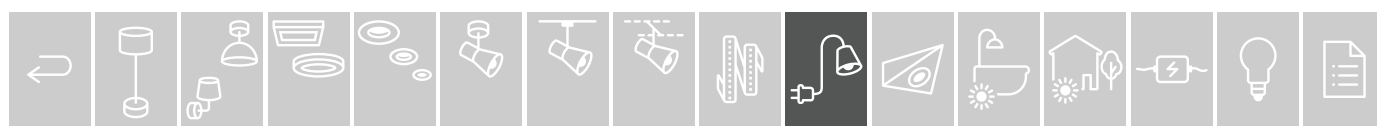



**Beam Thirty**

incl. 1×6 W  
630 lm, 2.700 K  
↙ 100°  
230 V  
↕46 ↔290 ↗190 mm  
EAN 4000870 998946

**998.94**

- 🔩 Nickel gebürstet/Chrom 📏 Metall
- 🔩 Nickel brossé/Chrome 📏 Métal
- 🔩 Nikkel geborsteld/Chroom 📏 Metaal

**Beam Fifty**

incl. 1×8 W  
850 lm, 2.700 K  
↙ 100°  
230 V  
↕46 ↔450 ↗190 mm  
EAN 4000870 998953

**998.95**

- 🔩 Nickel gebürstet/Chrom 📏 Metall
- 🔩 Nickel brossé/Chrome 📏 Métal
- 🔩 Nikkel geborsteld/Chroom 📏 Metaal

**Beam Sixty**

incl. 1×11 W  
1,250 lm, 2.700 K  
↙ 100°  
230 V  
↕46 ↔585 ↗190 mm  
EAN 4000870 998960

**998.96**

- 🔩 Nickel gebürstet/Chrom 📏 Metall
- 🔩 Nickel brossé/Chrome 📏 Métal
- 🔩 Nikkel geborsteld/Chroom 📏 Metaal

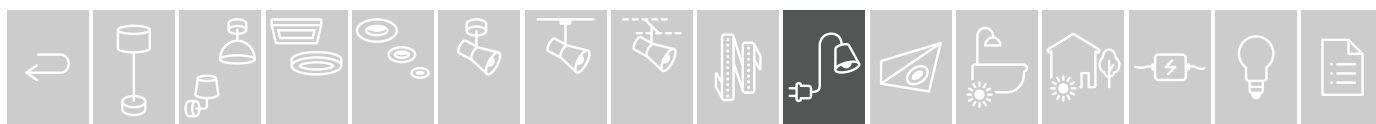

# Furniture

282 Clever Connect

290 Cabinet lights

301 Battery lights



## Clever Connect

Mit dem Clever Connect System lässt sich Möbelbeleuchtung individuell zusammenstellen und jederzeit erweitern. Durch Steckverbindungen lassen sich die Komponenten auf einfachste Weise miteinander kombinieren. Die Befestigung ist einfach – kleben oder schrauben. Möglich ist die Verbindung von Leuchte zu Leuchte oder mit der Verbinder-Box am Trafo. Alle Leuchten sind dimmbar und Tunable-White-fähig – mit der einzigartigen Fernbedienung. Dank magnetischer Halterung ist diese auch als Wandschalter einsetzbar.

L'éclairage des meubles peut être composé individuellement et étendu à tout moment avec le système Clever Connect. Les éléments sont très faciles à combiner entre eux grâce aux connexions rapides. Le montage est simple, par collage ou vissage. La connexion d'un luminaire à un autre ou au boîtier du connecteur est possible grâce au transfo. Tous les luminaires sont gradables et compatibles avec Tunable White grâce à la télécommande unique en son genre. Celle-ci est également utilisable comme commutateur mural grâce au support magnétique.

Met het Clever Connect systeem is meubelverlichting individueel samen te stellen en op elk moment uit te breiden. Door steekverbindingen kunnen de componenten op eenvoudige wijze met elkaar worden gecombineerd. De bevestiging is eenvoudig: lijmen of schroeven. Zowel een verbinding van armatuur naar armatuur als met de verbinderbox aan de trafo is mogelijk. Alle armaturen zijn dimbaar en geschikt voor tunable white - met de unieke afstandsbediening. Dankzij de magnetische houder is deze ook als wandschakelaar te gebruiken.

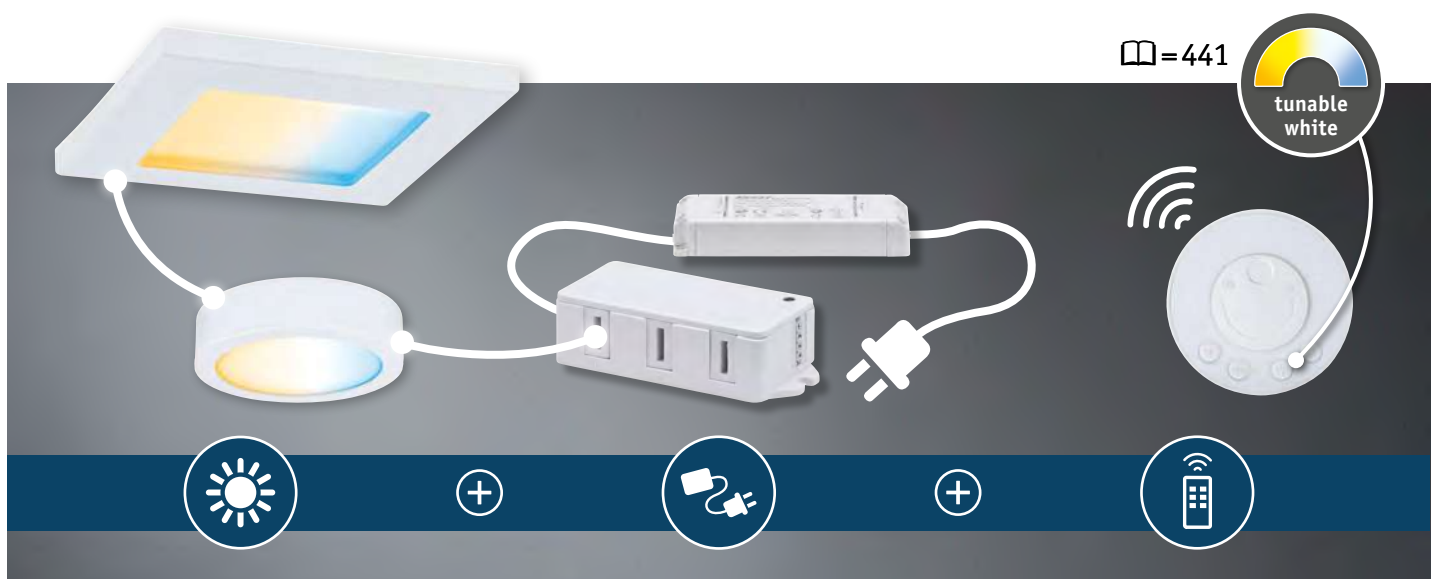



DE Auf dem Schrank  
FR Sur le meuble  
NL Op de kast



☰=282

# Clever Connect



☰=283

DE Im Schrank  
FR Dans le meuble  
NL In de kast

DE Unter dem Oberschrank  
FR Sous le meuble suspendu  
NL Onder de bovenkast



☰=283



DE Am Schranksockel  
FR Sur le socle du meuble  
NL Onderaan de kast

DE POS-Konzept – vielfältiges Sortiment auf kleiner Fläche  
FR Concept PDV – assortiment varié sur surface réduite  
NL POS-concept - veelzijdig assortiment op kleine oppervlakte

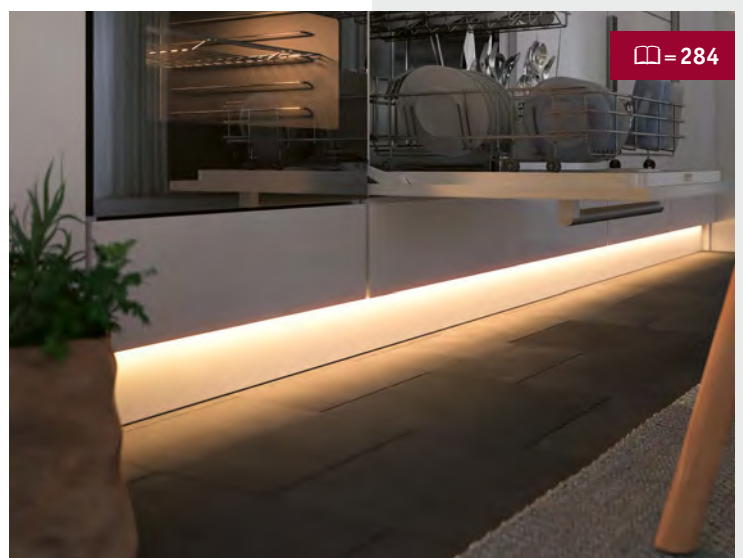

☰=284

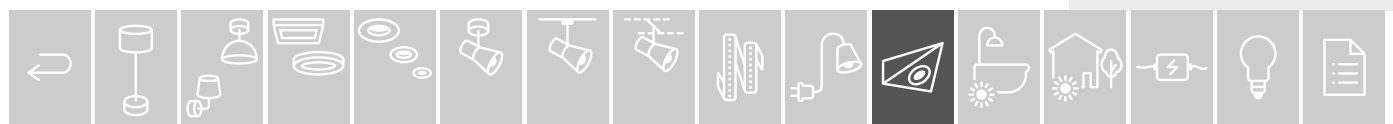



- 🌀 Weiß matt □ Kunststoff
- 🌀 Blanc dépoli □ Matière plastique
- 🌀 Wit mat □ Kunststof



  
**tunable white**  
 only with **999.76**  
 □=289

**Clever Connect Starter Set Mike**

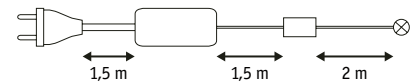
incl. 2×2 W  
 2×195 lm, 2.700 - 6.500 K  
 230/12 V, incl. ⚡ 12 VA  
 ⌀35 ⇄70 ⌀245 mm  
 EAN 4000870 999738  
**999.73** ⚡











- 🌀 Nickel gebürstet  Metall
- 🌀 Nickel brossé  Métal
- 🌀 Nikkel geborsteld  Metaal

  
**tunable white**  
 only with **999.76**  
 = 289

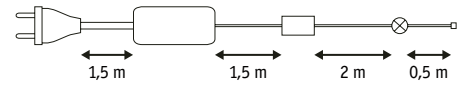
**Clever Connect Starter Set Trigo**



incl. 3×2,1 W  
 3×190 lm, 2.700 - 6.500 K  
 230/12 V, incl.  12 VA  
 ⌀45 ⇄124 ↗141 mm  
 EAN 4000870 999745  
**999.74** 



- 🌀 Weiß matt  Kunststoff
- 🌀 Blanc dépoli  Matière plastique
- 🌀 Wit mat  Kunststof

  
**tunable white**  
 only with **999.76**  
 = 289

**Clever Connect Starter Set Disc**

incl. 3×2,1 W  
 3×175 lm, 2.700 - 6.500 K  
 230/12 V, incl.  12 VA  
 ⌀17 ø65 mm  
 EAN 4000870 999752  
**999.75** 

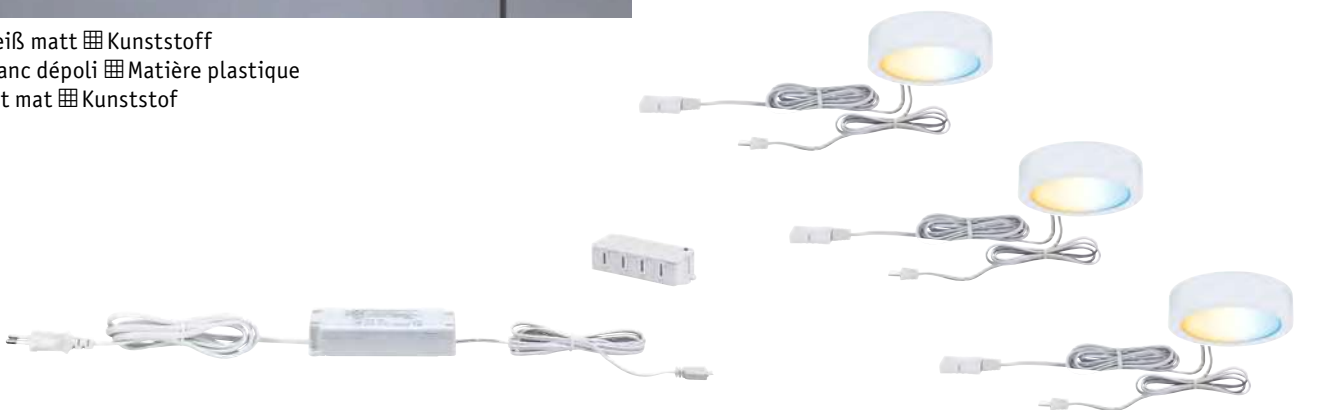
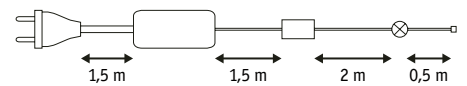









  
**tunable white**  
 only with 999.76  
 □=289



**Clever Connect Spot Mike**

incl. 1x2 W  
 195 lm, 2.700 - 6.500 K  
 12 V  
 ⤴35 ⤵70 ⤶245 mm  
 EAN 4000870 999493  
**999.49** 









 Weiß matt  Kunststoff  
 Blanc dépoli  
 Matière plastique  
 Wit mat  Kunststof

**Clever Connect Spot Mike**

incl. 1x2 W  
 195 lm, 2.700 - 6.500 K  
 12 V  
 ⤴35 ⤵70 ⤶245 mm  
 EAN 4000870 999509  
**999.50** 



 Chrom matt  Kunststoff  
 Chrome mat  
 Matière plastique  
 Chrom mat  Kunststof









  
**tunable white**  
 only with 999.76  
 □=289



**Clever Connect Stripe 1m**

incl. 1x6,5 W  
 550 lm, 2.700 - 6.500 K  
 12 V  
 ⤴1.000 ⤶12,5 mm  
 EAN 4000870 999721  
**999.72** 



 Transparent  Kunststoff  
 Transparent  
 Matière plastique  
 Transparant  Kunststof











  
**tunable white**  
 only with 999.76  
 □=289



**Clever Connect Spot Disc**

incl. 1x2,1 W  
 175 lm, 2.700 - 6.500 K  
 12 V  
 ⚡17 ⌀65 mm  
 EAN 4000870 999523  
**999.52** 









-  Weiß matt  Kunststoff
-  Blanc dépoli
-  Matière plastique
-  Wit mat  Kunststof

**Clever Connect Spot Disc**

incl. 1x2,1 W  
 175 lm, 2.700 - 6.500 K  
 12 V  
 ⚡17 ⌀65 mm  
 EAN 4000870 999530  
**999.53** 



-  Chrom matt  Kunststoff
-  Chrome mat
-  Matière plastique
-  Chroom mat  Kunststof









  
**tunable white**  
 only with 999.76  
 □=289



**Clever Connect Spot Medal**

incl. 1x2,3 W  
 155 lm, 2.700 - 6.500 K  
 12 V  
 ⚡15 ⌀43 mm  
 EAN 4000870 999547  
**999.54** 









-  Weiß matt  Kunststoff
-  Blanc dépoli
-  Matière plastique
-  Wit mat  Kunststof

**Clever Connect Spot Medal**

incl. 1x2,3 W  
 155 lm, 2.700 - 6.500 K  
 12 V  
 ⚡15 ⌀43 mm  
 EAN 4000870 999554  
**999.55** 



-  Chrom matt  Kunststoff
-  Chrome mat
-  Matière plastique
-  Chroom mat  Kunststof









  
**tunable white**  
 only with 999.76  
 □=289



**Clever Connect Spot Pola**

incl. 1x2,5 W  
 145 lm, 2.700 - 6.500 K  
 12 V  
 ⚡4 ⇄70 ⇄70 mm  
 EAN 4000870 999615  
**999.61** 









-  Weiß matt  Kunststoff
-  Blanc dépoli
-  Matière plastique
-  Wit mat  Kunststof

**Clever Connect Spot Pola**

incl. 1x2,5 W  
 145 lm, 2.700 - 6.500 K  
 12 V  
 ⚡4 ⇄70 ⇄70 mm  
 EAN 4000870 999608  
**999.60** 





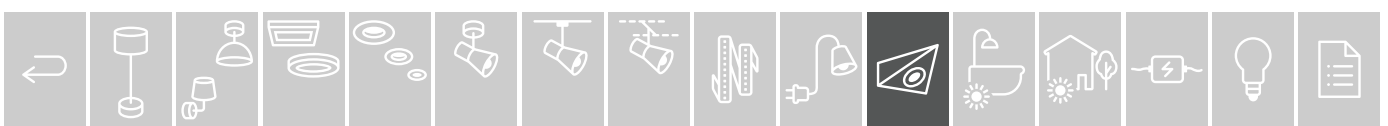



-  Chrom matt  Kunststoff
-  Chrome mat
-  Matière plastique
-  Chroom mat  Kunststof





  
**tunable white**  
 only with 999.76  
 □ = 289

-  Weiß matt  Kunststoff
-  Blanc dépoli  Matière plastique
-  Wit mat  Kunststof



**Clever Connect Spot Border 300mm**

incl. 1x5 W  
 460 lm, 2.700 - 6.500 K  
 12 V  
 ⚡8 ↔300 ↗38 mm  
 EAN 4000870 999622  
**999.62** 



**Clever Connect Spot Border 500mm**

incl. 1x7,5 W  
 700 lm, 2.700 - 6.500 K  
 12 V  
 ⚡8 ↔500 ↗38 mm  
 EAN 4000870 999639  
**999.63** 



**Border Edge-Connector**

12 V  
 ⚡50 ↗50 mm  
 EAN 4000870 999646  
**999.64** 



**Border T-Connector**

12 V  
 ⚡50 ↗50 mm  
 EAN 4000870 999653  
**999.65** 



**Border X-Connector**

12 V  
 ⚡50 ↗50 mm  
 EAN 4000870 999660  
**999.66** 



**Border Wall-Connector**

12 V  
 ⚡38 ↔24 ↗24 mm  
 EAN 4000870 999677  
**999.67** 



**Border Line-Connector**



12 V  
 ⚡37 ↗20 mm  
 EAN 4000870 999929  
**999.92**







  
**tunable white**  
 only with 999.76  
 □=289

☞ Chrom matt  Kunststoff  
 ☞ Chrome mat  Matière plastique  
 ☞ Chroom mat  Kunststof



**Clever Connect Spot Barre 350mm**

incl. 1×3,5 W  
 330 lm, 2.700 - 6.500 K  
 12 V  
 ⌀10 ⇄350 ↗25 mm  
 EAN 4000870 999684  
**999.68** 



**Clever Connect Spot Barre 500mm**

incl. 1×6,5 W  
 610 lm, 2.700 - 6.500 K  
 12 V  
 ⌀10 ⇄550 ↗25 mm  
 EAN 4000870 999691  
**999.69** 



**Barre Edge-Connector**

12 V  
 ⌀10 ⇄50 ↗50 mm  
 EAN 4000870 999707  
**999.70** 



**Barre Line-Connector**

12 V  
 ⌀10 ⇄50 ↗25 mm  
 EAN 4000870 999714  
**999.71** 

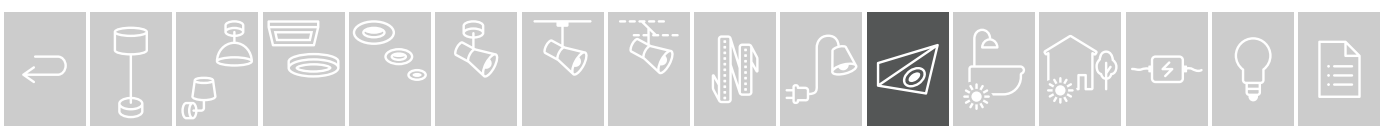









  
**tunable white**  
 only with 999.76  
 □=289









**Clever Connect Spot Neda**

incl. 1x2,1 W  
 180 lm, 2.700 - 6.500 K  
 12 V  
 ⌀70 ⇄64 ⌀151 mm  
 EAN 4000870 999578  
**999.57** 

-  Weiß matt  Kunststoff
-  Blanc dépoli
-  Matière plastique
-  Wit mat  Kunststof

**Clever Connect Spot Neda**

incl. 1x2,1 W  
 180 lm, 2.700 - 6.500 K  
 12 V  
 ⌀70 ⇄64 ⌀151 mm  
 EAN 4000870 999561  
**999.56** 

-  Chrom matt  Kunststoff
-  Chrome mat
-  Matière plastique
-  Chroom mat  Kunststof





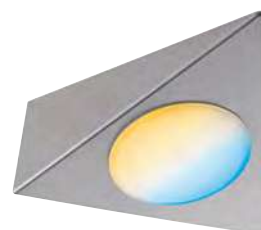
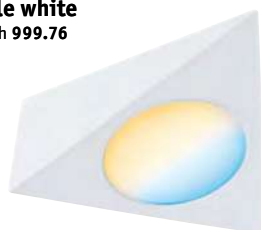



  
**tunable white**  
 only with 999.76  
 □=289









**Clever Connect Spot Trigo**

incl. 1x2,1 W  
 190 lm, 2.700 - 6.500 K  
 12 V  
 ⌀45 ⇄124 ⌀141 mm  
 EAN 4000870 999592  
**999.59** 

-  Weiß matt  Metall
-  Blanc dépoli  Métal
-  Wit mat  Metaal

**Clever Connect Spot Trigo**

incl. 1x2,1 W  
 190 lm, 2.700 - 6.500 K  
 12 V  
 ⌀45 ⇄124 ⌀141 mm  
 EAN 4000870 999585  
**999.58** 

-  Nickel gebürstet  Metall
-  Nickel brossé  Métal
-  Nikkel geborsteld  Metaal









  
**tunable white**  
 only with 999.76  
 □=289



**Clever Connect Panel Flad**

incl. 1x6 W  
 600 lm, 2.700 - 6.500 K  
 12 V  
 ⌀7,6 ⇄200 ⌀300 mm  
 EAN 4000870 999516  
**999.51** 

-  Weiß matt  Kunststoff
-  Blanc dépoli
-  Matière plastique
-  Wit mat  Kunststof

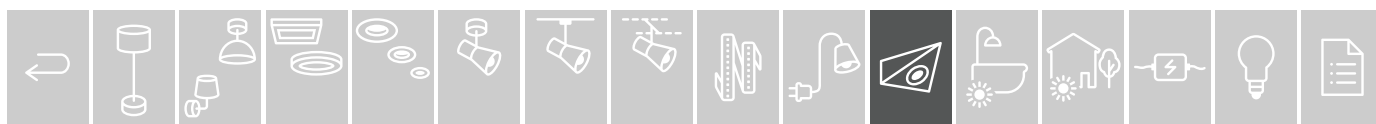

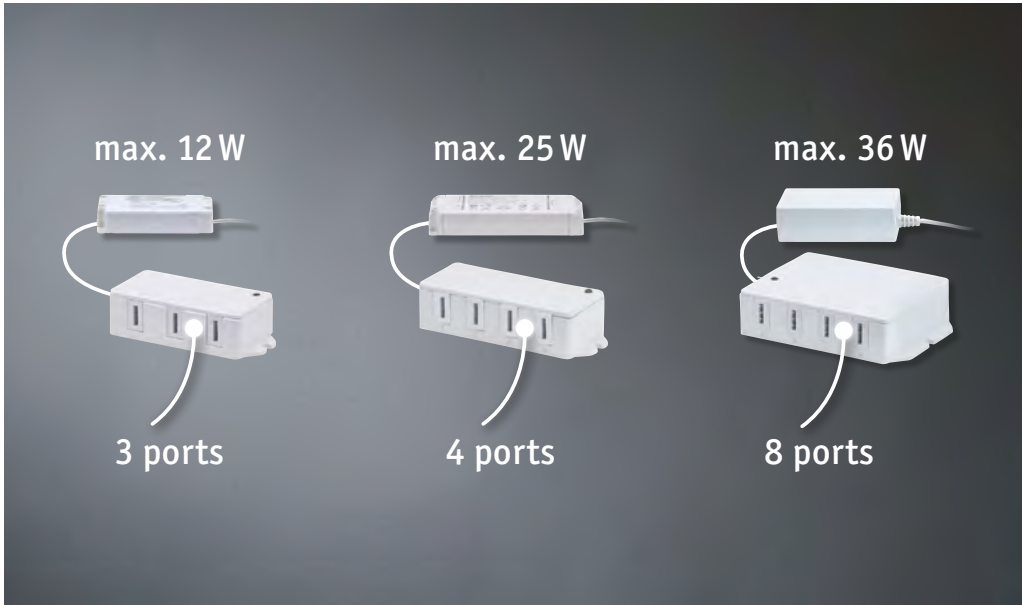

⌘ Weiß ▣ Kunststoff  
 ⌘ Blanc ▣ Matière plastique  
 ⌘ Wit ▣ Kunststof



**Clever Connect Driver**

max. 12 W  
 230/12 V, incl. ⚡ 12 VA  
 ⚡ 18 ↔ 72 ⚡ 31 mm  
 EAN 4000870 999462  
**999.46**



**Clever Connect Driver**

max. 25 W  
 230/12 V, incl. ⚡ 25 VA  
 ⚡ 19 ↔ 81 ⚡ 30 mm  
 EAN 4000870 999479  
**999.47**



**Clever Connect Driver**

max. 36 W  
 230/12 V, incl. ⚡ 36 VA  
 ⚡ 19 ↔ 82 ⚡ 54 mm  
 EAN 4000870 999486  
**999.48**



Remote Control  
 incl. memory function



**Clever Connect Switch Bowl**

1xCR2450  
 ⚡ 23 ⌀ 71 mm  
 EAN 4000870 999769  
**999.76**



⌘ Weiß matt ▣ Kunststoff  
 ⌘ Blanc dépoli ▣ Matière plastique  
 ⌘ Wit mat ▣ Kunststof

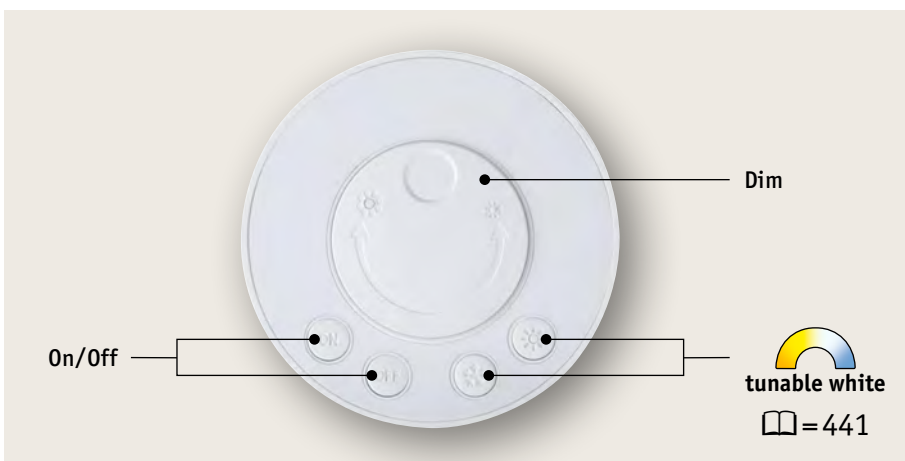

► Tunable White in jeder Leuchte – Steuerung über die Fernbedienung, auch als Wandschalter einsetzbar

► Tunable White dans chaque luminaire - Contrôle par la télécommande, utilisable également comme commutateur mural

► Tunable white in elke armatuur – besturing via de afstandsbediening, ook als wandschakelaar te gebruiken





Unterschrankleuchten für die optimale Ausleuchtung, z.B. von Arbeitsbereichen in der Küche, von Wandschränken oder Regalen.

Appliques sous placards pour un éclairage optimal, par exemple des plans de travail dans la cuisine, des placards muraux ou des étagères.

Onderkastlampen voor de optimale verlichting van bijv. werkbladen in de keuken, wandkasten of rekken.



**Furniture LED Leaf**

Alu Alu Alu



Alu gebürstet Alu brossé Alu geborsteld

**incl. 3x4,7 W**  
 3x310 lm, 2.700 K  
 ∠ 120°  
 230/12 V, incl. 15 VA  
 EAN 4000870 935613  
**935.61**

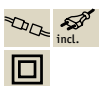
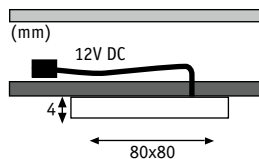

Alu gebürstet Alu brossé Alu geborsteld

**incl. 3x4 W**  
 3x280 lm, 2.700 K  
 ∠ 120°  
 230/12 V, incl. 12 VA  
 EAN 4000870 935620  
**935.62**

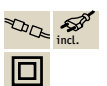
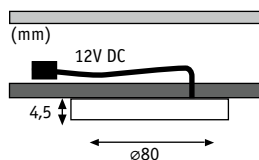

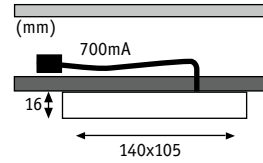

### Furniture LED Vane

Alu Alu Alu



Wei matt Blanc d poli Wit mat

#### incl. 1x6,7 W

450 lm, 2.700 K  
230/12 V, incl. 8 VA  
EAN 4000870 920329  
**920.32**

#### incl. 2x6,7 W

2x450 lm, 2.700 K  
230/12 V, incl. 15 VA  
EAN 4000870 935835  
**935.83**

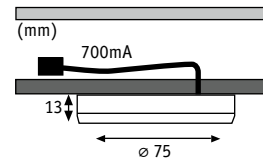

### Furniture LED Unity

Metall/Acryl M tal/Acryl Metaal/Acryl



Eisen geb rstet Acier bross  Staal geborsteld

#### incl. 3x4,5 W

3x360 lm, 2.700 K  
  120   
230 V, incl. 15 VA  
EAN 4000870 935644  
**935.64**

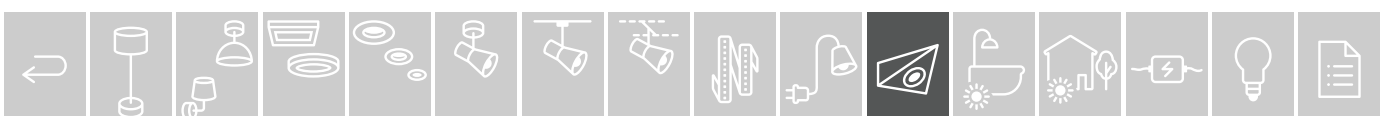

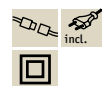
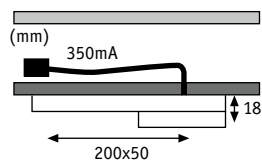

**Furniture LED Setup**

☒ Metal/Acryl Métal/Acryl Metaal/Acryl



☞ Eisen gebürstet Acier brossé Staal geborsteld

**incl. 3×3,2 W**

3×250 lm, 2.700 K

⊘ 120°

230 V, incl. ⚡ 15 VA

EAN 4000870 935675

**935.67**

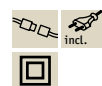
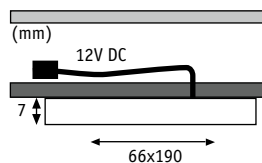

**Furniture LED Pattern**

☒ Kunststoff Matière plastique Kunststof



☞ Chrom matt Chrome mat Chroom mat

**incl. 3×2,2 W**

3×160 lm, 2.700 K

⊘ 70°

230/12 V, incl. ⚡ 12 VA

EAN 4000870 935637

**935.63**

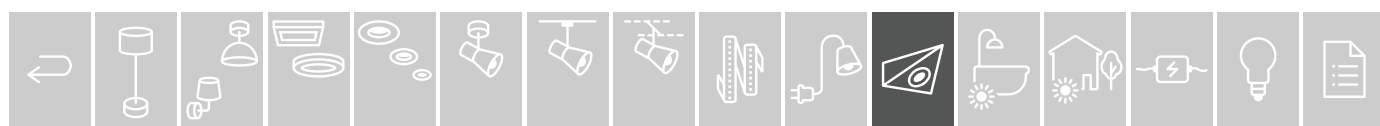

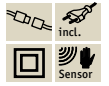
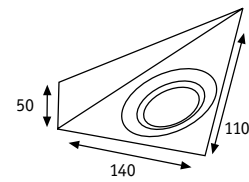

(mm)

**Furniture LED Triangle Sensor**    Metal/Glas Métal/Verre Metaal/Glas

Eisen gebürstet Acier brossé Staal geborsteld



**incl. 3×2,8 W**

3×170 lm, 2.700 K

∠ 100°

230/12 V, incl. 12 VA

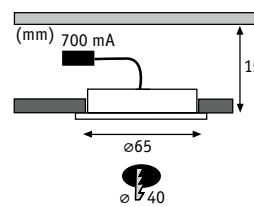
EAN 4000870 935729

**935.72**

**Furniture Whirl Mini LED**    Acryl Acryl Acryl

Satin Satiné Satijn

**incl. 3×2,4 W**

3×115 lm, 2.700 K

∠ 100°

230 V, incl. 7 VA

EAN 4000870 998656

**998.65**

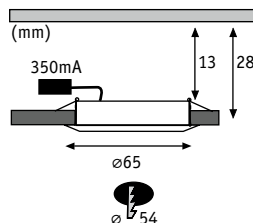
**Mirror Cabinet downlight**

Aluminium/Kunststoff Aluminium/Matière plastique Aluminium/Kunststof

- Umrüstsatz für Spiegelschränke
- Kit équipement pour armoires de toilette
- Uitrustingsset voor spiegelkasten

Weiß matt Blanc dépoli  
Wit mat



**incl. 2x2,5 W**  
2x225 lm, 3.000 K  
∠ 85°  
230/12 V, incl. 7 VA  
EAN 4000870 999219  
**999.21**

Chrom Chrome Chrom



**incl. 2x2,5 W**  
2x225 lm, 3.000 K  
∠ 85°  
230/12 V, incl. 7 VA  
EAN 4000870 999202  
**999.20**

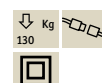
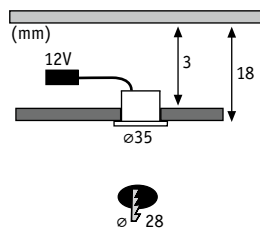

**Furniture Mini LED**

Metall Métal Metaal

Eisen gebürstet Acier brossé Staal geborsteld



**incl. 5x0,4 W**  
5x20 lm, 2.700 K  
∠ 90°  
230/12 V, incl. 3,6 VA  
EAN 4000870 935866  
**935.86**

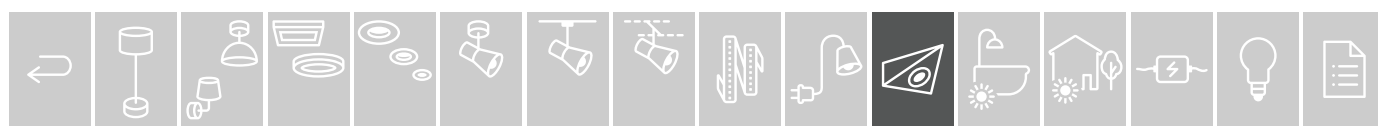



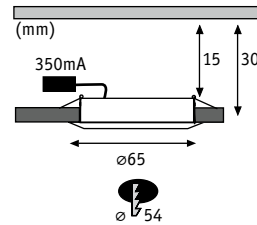

## Furniture LED

Metall Métal Metaal

Wei Blanc Wit

**incl. 3x4,5 W**

3x305 lm, 2.700 K  
 ✗ 180°  
 230 V, incl. 12 VA  
 EAN 4000870 935545  
**935.54**

**incl. 1x4,5 W**

305 lm, 2.700 K  
 ✗ 180°  
 230 V, incl. 6 VA  
 EAN 4000870 935552  
**935.55**

Chrom Chrome Chroom

**incl. 3x4,5 W**

3x305 lm, 2.700 K  
 ✗ 180°  
 230 V, incl. 12 VA  
 EAN 4000870 935521  
**935.52**

Eisen gebrstet Acier bross Staal geborsteld

**incl. 3x4,5 W**

3x305 lm, 2.700 K  
 ✗ 180°  
 230 V, incl. 12 VA  
 EAN 4000870 935538  
**935.53**





Perfect match

□ = 397

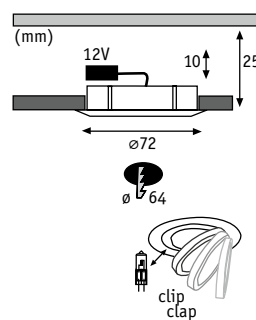

### Furniture Klipp Klapp

Metall/Glas Métal/Verre Metaal/Glas

Wei Blanc Wit

**max. 20 W**

12 V  
EAN 4000870 984666

**984.66**



Chrom Chrome Chrom

**max. 20 W**

12 V  
EAN 4000870 984024

**984.02**



Eisen gebrstet Acier bross Staal geborsteld

**max. 20 W**

12 V  
EAN 4000870 984079

**984.07**

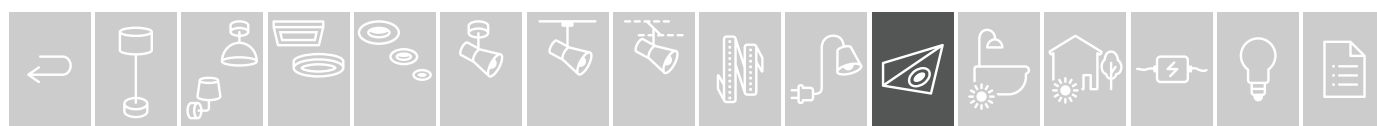

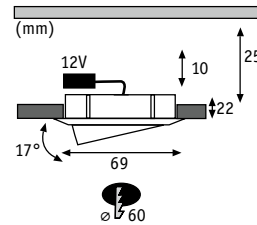
**Micro Line Swivel**

Metall/Glas Métal/Verre Metaal/Glas



Eisen gebürstet Acier brossé Staal geborsteld

**max. 20 W**

12 V

EAN 4000870 984741

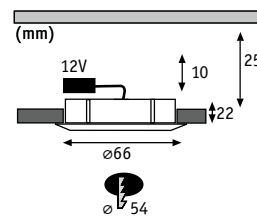
**984.74** **Micro Line Structure**

Metall/Glas Métal/Verre Metaal/Glas



Weiß Blanc Wit

**max. 20 W**

12 V

EAN 4000870 984321

**984.32** 

Eisen gebürstet Acier brossé Staal geborsteld

**max. 20 W**

12 V

EAN 4000870 984499

**984.49** 

Chrom Chrome Chroom

**max. 20 W**

12 V

EAN 4000870 984628

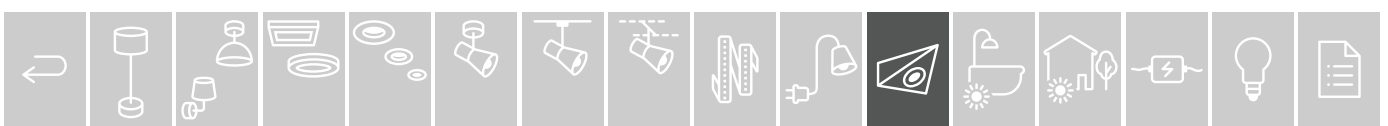
**984.62** 

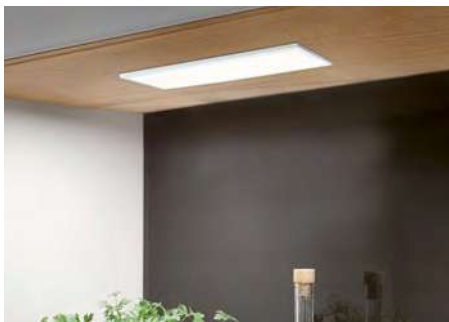

**Ace Basic**

Metall/Kunststoff Métal/Matière plastique Metaal/Kunststof



Wei/Satin Blanc/Satiné Wit/Satijn

**incl. 1x7,5 W**  
 580 lm, 2.700 K  
 230/24 V, incl. 24 VA  
 EAN 4000870 707760  
**707.76**



Wei/Satin Blanc/Satiné Wit/Satijn

**incl. 1x7,5 W**  
 580 lm, 2.700 K  
 DC 24 V  
 EAN 4000870 707777  
**707.77**

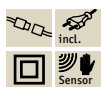
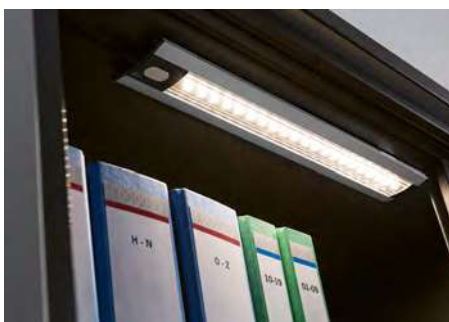

**TriX**

Alu/Kunststoff Alu/Matière plastique Alu/Kunststof

- |  |  |  |
|--|--|--|
| <ul style="list-style-type: none"> <li>▶ LED-Schrankleuchte</li> <li>▶ Klare Abdeckung mit Prismeneffekt</li> <li>▶ Superflaches, hochwertiges Aluprofil</li> <li>▶ Inkl. Touchschalter</li> <li>▶ Einfache Befestigung über Montageclips</li> <li>▶ Inkl. Power Supply</li> </ul> | <ul style="list-style-type: none"> <li>▶ Lampe pour meubles LED</li> <li>▶ Excellente couverture avec un effet de prismes</li> <li>▶ Profilé en aluminium de haute qualité extra-plat</li> <li>▶ Interrupteur tactile inclus</li> <li>▶ Fixation aisée grâce aux clips de montage</li> <li>▶ Alimentation incluse</li> </ul> | <ul style="list-style-type: none"> <li>▶ LED-kastlamp</li> <li>▶ Doorzichtige afdekking met prismaeffect</li> <li>▶ Zeer plat, hoogwaardig aluprofiel</li> <li>▶ Incl. touchschakelaar</li> <li>▶ Eenvoudige bevestiging via montageclips</li> <li>▶ Incl. Power Supply</li> </ul> |
|--|--|--|

Alu matt/Schwarz Alu mat/Noir Alu mat/Zwart



**incl. 1x4,2 W**

340 lm, 3.000 K

∠ 120°

230/12 V, incl. 7 VA

EAN 4000870 703984

**703.98**



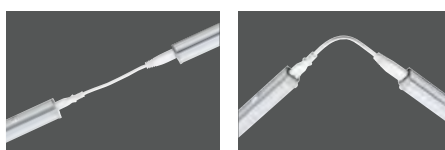

**Bond**

Alu/Kunststoff Alu/Matière plastique Alu/Kunststof

- ▶ Verkettbare LED-Lichtleiste mit transparenten Endkappen für ein optisch unterbrechungsfreies Lichtband. Die Leuchten lassen sich durch einen integrierten Verbindungsstecker aneinanderreihen. Jede Leuchte einzeln schaltbar. Einfach Installation mit Montage-Clips.
- ▶ Inkl. Zuleitung mit Eurostecker
- ▶ Inkl. Verbindungsleistung für Kurven oder Übergänge
- ▶ Minimale Abmessungen
- ▶ Réglette LED combinable avec embouts transparents pour une bande lumineuse sans interruption optique. Les luminaires se combinent l'un après l'autre grâce au connecteur intégré. Chaque luminaire s'allume individuellement. Pose facile grâce aux clips de montage.
- ▶ Fourni avec un câble d'alimentation doté d'un connecteur Euro
- ▶ Fourni avec le matériel de connexion pour courbes ou jonctions
- ▶ Dimensions minimales
- ▶ Aaneenschakelbare LED-lichtbalk met transparante eindkappen voor een optisch ononderbroken lichtband. De lampen kunnen met een geïntegreerde verbindingsstecker met elkaar worden verbonden. Elke lamp afzonderlijk schakelbaar. Eenvoudige installatie met montageclips.
- ▶ Incl. toevoerleiding met eurostekker
- ▶ Incl. verbindingsleiding voor bochten of overgangen
- ▶ Minimale afmetingen

🌀 Satin Satiné Satijn



**incl. 1x5 W**

370 lm, 4.000 K  
230 V  
EAN 4000870 706060  
**706.06**

**incl. 1x8 W**

720 lm, 4.000 K  
230 V  
EAN 4000870 706121  
**706.12**

**incl. 1x12 W**

950 lm, 4.000 K  
230 V  
EAN 4000870 706138  
**706.13**

**incl. 1x15 W**

1,200 lm, 4.000 K  
230 V  
EAN 4000870 706145  
**706.14**

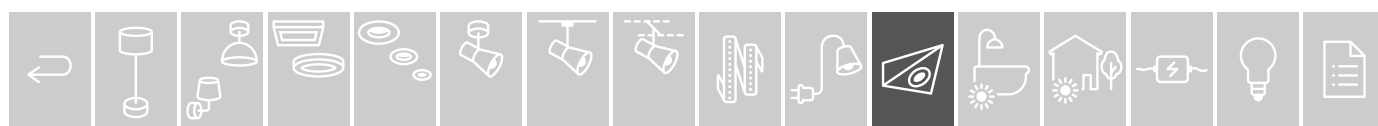



### SnapLED

☒ Kunststoff Matière plastique Kunststof

- ▶ Optimal für Schiebetüren: LED-Schrankleuchte mit Gleitrolle für den Batteriebetrieb. Die Gleitrolle schaltet die Leuchte beim Öffnen einer Schranktür automatisch ein und wieder aus. Einfach Licht wo Sie es brauchen.
  - ▶ Einfache Befestigung abnehmbaren Montageboden mit Klebepads oder Schrauben fixieren
  - ▶ Leicht zugängliches Batteriefach
  - ▶ Betrieb mit 4x1,5V AAA (exkl.)
  - ▶ Klare Abdeckung und Reflektor für optimierte Lichtausbeute
- ▶ Idéal pour les portes coulissantes : petit éclairage LED avec roulette pour le fonctionnement de la batterie. La roulette allume et éteint automatiquement la lumière à l'ouverture et à la fermeture de la porte de l'armoire. Un éclairage facile là où vous en avez besoin.
  - ▶ Fixation simple au sol avec des pastilles autocollantes ou des vis
  - ▶ Compartiment de la batterie facilement accessible
  - ▶ Fonctionne avec 4x1,5V AAA (non incluses)
  - ▶ Revêtement et réflecteur clairs pour un rendement lumineux optimal
- ▶ Optimaal voor schuifdeuren: LED-kleinlicht met glijrol voor batterijgebruik. De glijrol schakelt de lamp door openen van een kastdeur automatisch in en weer uit. Eenvoudig: licht waar u het nodig heeft.
  - ▶ Eenvoudige bevestiging van afneembare montagevloeren met hecht pads of schroeven fixeren
  - ▶ Eenvoudig toegankelijk batterijvak
  - ▶ Bedrijf met 4x1,5V AAA (excl.)
  - ▶ Heldere afdekking en reflector voor geoptimaliseerde lichtrendement

🌀 Silber Argent Zilver



**incl. 1x0,33 W**

30 lm, 2.700 K

∠ 120°

4xAAA/1,5V (Micro)

EAN 4000870 704981

**704.98** 🛒

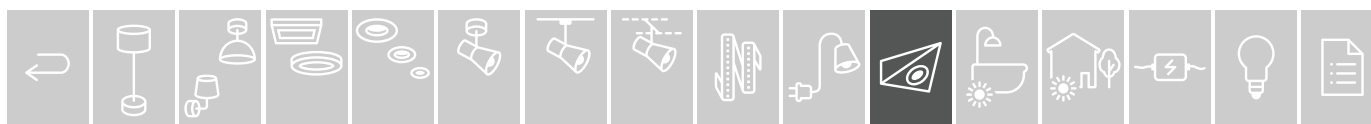



- ▶ Multifunktionale Batterieleuchten mit vielfältigen Einsatzmöglichkeiten in Möbeln oder unter Hängeschränken für gleichmäßiges Arbeitslicht, gerichtete Spot-Beleuchtung oder hilfreiches Orientierungslicht. Je nach Modell dimmbar, mit schwenkbaren Spotköpfen oder Bewegungsmelder ausgestattet.
- ▶ Inkl. Montageplatte für einfachen Batteriewechsel
- ▶ Einfache Befestigung mit Klebe- oder Klett pads
- ▶ Luminaires à pile multifonctionnels avec de nombreuses possibilités d'utilisation dans les meubles ou sous les placards, fournissant une lumière de travail uniforme, un éclairage spot ciblé ou un éclairage de balisage.
- ▶ Fourni avec une plaque de montage pour un remplacement facile des piles
- ▶ Fixation facile avec des pattes adhésives ou velcro
- ▶ Multifunctionele batterijlampen met veelzijdige toepassingsmogelijkheden in meubels of onder hangkasten voor gelijkmatig werklicht, gerichte spotverlichting of handige oriëntatieverlichting. Afhankelijk van het model dimbaar, met zwenkbare spotkoppen of bewegingsmelder uitgerust.
- ▶ Incl. montageplaat voor eenvoudige batterijwissel
- ▶ Eenvoudige bevestiging met kleef- of klittenbandpads

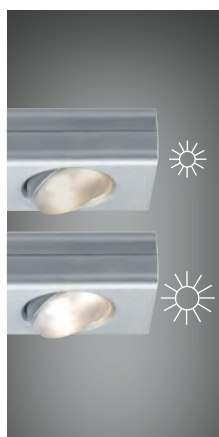

**Jiggle**

incl. 3×0,18 W  
 3×22 lm, 3.000 K  
 ✕ 105°  
 6xAAA/1,5V (Micro)  
 ⚡35 ⇄300 ↗60 mm  
 EAN 4000870 706350  
**706.35** 📦



🌀 Chrom matt 📦 Kunststoff  
 🌀 Chrome mat 📦 Matière plastique  
 🌀 Chroom mat 📦 Kunststof



**Rotate**

incl. 3×0,2 W  
 3×18 lm, 3.000 K  
 ✕ 105°  
 6xAAA/1,5V (Micro)  
 ⚡50 ⇄310 ↗60 mm  
 EAN 4000870 706367  
**706.36** 📦



🌀 Anthrazit/Chrom matt 📦 Kunststoff  
 🌀 Anthracite/Chrome mat  
 📦 Matière plastique  
 🌀 Antraciet/Chroom mat 📦 Kunststof







### SmartLight

incl. 1x1,6 W  
 140 lm, 3.000 K  
 <math>\sphericalangle</math> 100°  
 3xAA/1,5 V (Mignon)  
 <math>\updownarrow</math>27 <math>\leftrightarrow</math>250 <math>\curvearrowright</math>55 mm  
 EAN 4000870 706381  
**706.38**

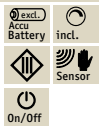

Chrom matt Kunststoff  
 Chrome mat Matière plastique  
 Chromo mat Kunststof



### Rotate

incl. 1x1 W  
 66 lm, 3.000 K  
 <math>\sphericalangle</math> 20°  
 3xAA/1,5 V (Mignon)  
 <math>\varnothing</math>92 <math>\curvearrowright</math>72 mm  
 EAN 4000870 706374  
**706.37**



Chrom matt Kunststoff  
 Chrome mat Matière plastique  
 Chromo mat Kunststof



### ButtonLED

incl. 1x0,6 W  
 70 lm, 3.000 K  
 <math>\sphericalangle</math> 105°  
 3xAAA/1,5V (Micro)  
 <math>\updownarrow</math>41 <math>\varnothing</math>88 mm  
 EAN 4000870 706398  
**706.39**



Anthrazit Kunststoff  
 Anthracite Matière plastique  
 Antraciet Kunststof

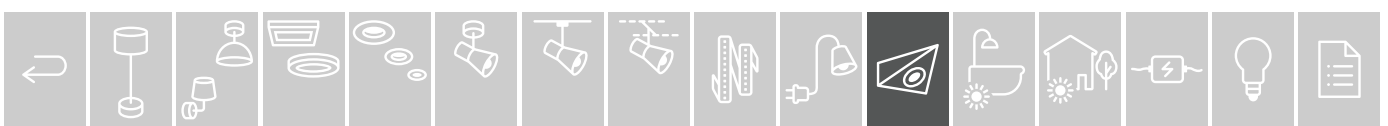

# Bathroom



☑ = 444



☑ = 317



☑ = 305



☑ = 318





**Aviar**

incl. 1x22,5 W  
 2.400 lm, 2.700 K  
 230 V  
 ⚡62 ø300 mm  
 EAN 4000870 708828  
**708.82**

IP44



R, C

- 🔩 Chrom 🧱 Kunststoff
- 🔩 Chrome 🧱 Matière plastique
- 🔩 Chroom 🧱 Kunststof

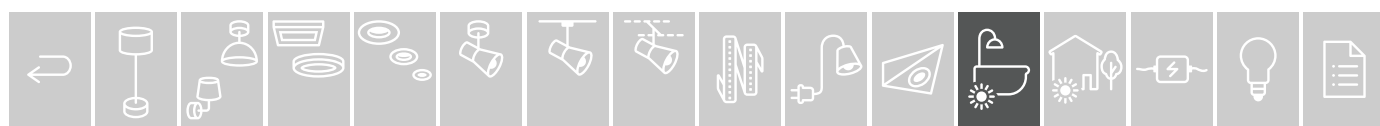



- Wei matt Kunststoff
- Blanc dpoli Matire plastique
- Wit mat Kunststof



**Cela**

incl. 1x15,5 W  
 2.200 lm, 3.000 - 6.500 K  
 230 V  
 50 280 280 mm  
 EAN 4000870 798393  
**798.39**



- Wei Kunststoff
- Blanc Matire plastique
- Wit Kunststof



**Leonis**

incl. 1x10,4 W  
 1.200 lm, 2.700 K  
 230 V, incl. 14,5 VA  
 95 280 mm  
 EAN 4000870 707227  
**707.22**

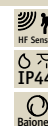

**Leonis**

incl. 1x10 W  
 1.280 lm, 3.000 K  
 230 V  
 95 280 mm  
 EAN 4000870 709818  
**709.81**



- Wei Kunststoff
- Blanc Matire plastique
- Wit Kunststof



**Leonis**

incl. 1x9,5 W  
 1.200 lm, 4.000 K  
 230 V, incl. 14,5 VA  
 95 280 mm  
 EAN 4000870 707241  
**707.24**

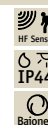

**Leonis**

incl. 1x10 W  
 1.310 lm, 4.000 K  
 230 V  
 95 280 mm  
 EAN 4000870 709801  
**709.80**

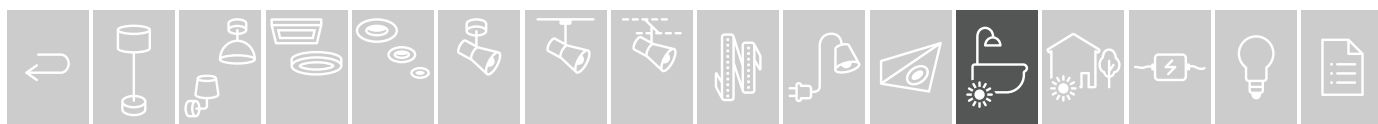



**Doradus**

incl. 2×4,7 W  
2×420 lm, 3.000 K  
230 V  
⌀95 ⇔230 ⌀42 mm  
EAN 4000870 708835  
**708.83**



**Doradus**

incl. 3×4,7 W  
3×420 lm, 3.000 K  
230 V  
⌀95 ⇔350 ⌀42 mm  
EAN 4000870 708767  
**708.76**



**Doradus**

incl. 3×4,7 W  
3×420 lm, 3.000 K  
230 V  
⌀42 ⌀250 mm  
EAN 4000870 708743  
**708.74**



- 🔩 Chrom 📦 Metall/Kunststoff
- 🔩 Chrome 📦 Métal/Matière plastique
- 🔩 Chroom 📦 Metaal/Kunststof

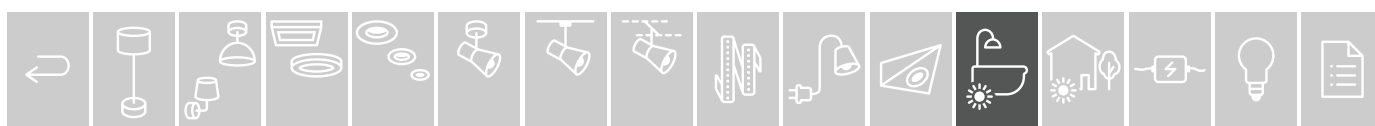



**Carina**

max. 28W, G9  
230V  
⌀157 ⌀105 ⇄105 ↗115 mm  
EAN 4000870 708385  
**708.38**

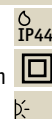

- ⌘ Chrom matt/Satin ▣ Metall/Glas
- ⌘ Chrome mat/Satiné ▣ Métal/Verre
- ⌘ Chroom mat/Satijn ▣ Metaal/Glas



**Eleon**

max. 33W, G9  
230V  
⌀203 ⌀105 ⇄105 ↗135 mm  
EAN 4000870 708392  
**708.39**



- ⌘ Chrom/Satin ▣ Metall/Glas
- ⌘ Chrome/Satiné ▣ Métal/Verre
- ⌘ Chroom/Satijn ▣ Metaal/Glas



**Gemini Set**

max. 2x20W, E14  
230V  
⌀195 ⇄85 ↗105 mm  
EAN 4000870 703540  
**703.54**



- ⌘ Chrom/Satin ▣ Metall/Glas
- ⌘ Chrome/Satiné ▣ Métal/Verre
- ⌘ Chroom/Satijn ▣ Metaal/Glas

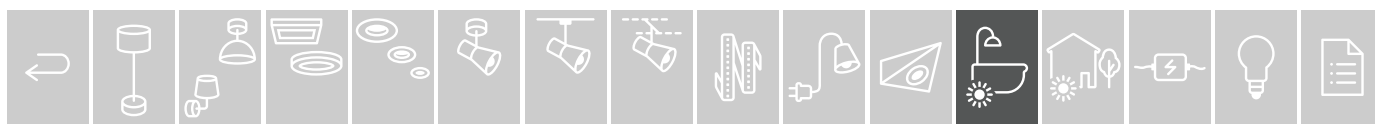

**Lenia**

max. 2×20 W, E14  
230 V  
⌀80 ⇄330 ↗105 mm  
EAN 4000870 703502  
**703.50**



⌘ Chrom/Opak ▣ Metall/Glas  
⌘ Chrome/Opaque ▣ Métal/Verre  
⌘ Chroom/Opaak ▣ Metaal/Glas

**Lukida**

incl. 1×9 W  
650 lm, 3.000 K  
230 V, incl. ⚡10 VA  
⌀100 ⇄600 ↗42 mm  
EAN 4000870 704639  
**704.63**



⌘ Chrom/Weiß ▣ Alu/Acryl  
⌘ Chrome/Blanc ▣ Alu/Acryl  
⌘ Chroom/Wit ▣ Alu/Acryl

**Nembus**

incl. 1×9 W  
600 lm, 3.000 K  
230 V, incl. ⚡10 VA  
⌀68 ⇄600 ↗63 mm  
EAN 4000870 704646  
**704.64**



⌘ Chrom/Weiß ▣ Metall/Acryl  
⌘ Chrome/Blanc ▣ Métal/Acryl  
⌘ Chroom/Wit ▣ Metaal/Acryl

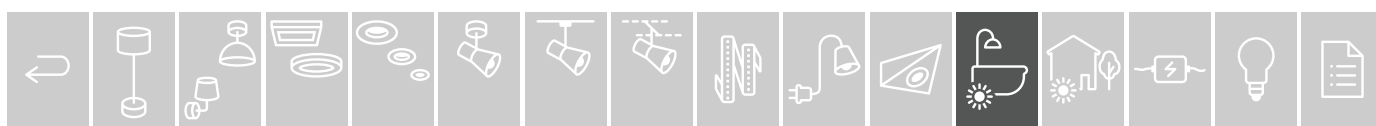

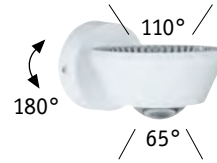
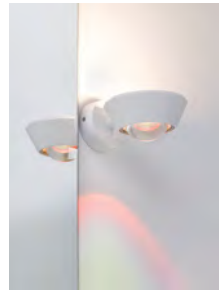

**Sabik**

incl. 1x9 / 1x4 W  
840 + 320 lm, 2.700 K  
230 V  
Ø80 ⇄117 ⌀152 mm  
EAN 4000870 709467  
**709.46**



↳ Weiß matt ▣ Kunststoff  
↳ Blanc dépoli ▣ Matière plastique  
↳ Wit mat ▣ Kunststof

incl. dichroic foil

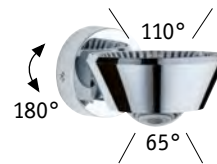

**Sabik**

incl. 1x9 / 1x4 W  
840 + 320 lm, 2.700 K  
230 V  
Ø80 ⇄117 ⌀152 mm  
EAN 4000870 709474  
**709.47**



↳ Chrom ▣ Kunststoff  
↳ Chrome ▣ Matière plastique  
↳ Chroom ▣ Kunststof

incl. dichroic foil

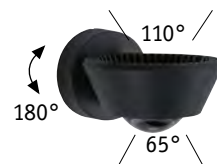

**Sabik**

incl. 1x9 / 1x4 W  
840 + 320 lm, 2.700 K  
230 V  
Ø80 ⇄117 ⌀152 mm  
EAN 4000870 797693  
**797.69 new**



↳ Schwarz ▣ Kunststoff  
↳ Noir ▣ Matière plastique  
↳ Zwart ▣ Kunststof

incl. dichroic foil

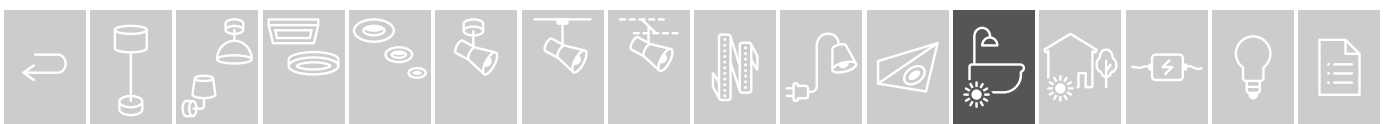





**Agena**

incl. 1x20 W  
 1.800 lm, 2.700 K  
 230 V  
 ⌀50 ⇄310 ⌀125 mm  
 EAN 4000870 709481  
**709.48**

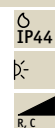

- 🌀 Chrom/Weiß matt ▣ Alu/Edelstahl
- 🌀 Chrome/Blanc dépoli ▣ Alu/Acier inoxydable
- 🌀 Chroom/Wit mat ▣ Alu/edelstaal



**Arneb**

incl. 1x9 W  
 700 lm, 3.000 K  
 230 V  
 ⌀40 ⇄326 ⌀78 mm  
 EAN 4000870 708781  
**708.78**



- 🌀 Weiß ▣ Alu/Acryl
- 🌀 Blanc ▣ Alu/Acryl
- 🌀 Wit ▣ Alu/Acryl



**Arneb**

incl. 1x9 W  
 700 lm, 3.000 K  
 230 V  
 ⌀40 ⇄326 ⌀78 mm  
 EAN 4000870 708798  
**708.79**



- 🌀 Chrom ▣ Alu/Acryl
- 🌀 Chrome ▣ Alu/Acryl
- 🌀 Chroom ▣ Alu/Acryl



**Kuma**

incl. 1x9 W  
 660 lm, 3.000 K  
 230 V, incl. ⚡10 VA  
 ⌀45 ⇄500 ⌀84 mm  
 EAN 4000870 704707  
**704.70**



- 🌀 Chrom/Weiß ▣ Metall/Acryl
- 🌀 Chrome/Blanc ▣ Métal/Acryl
- 🌀 Chroom/Wit ▣ Metaal/Acryl

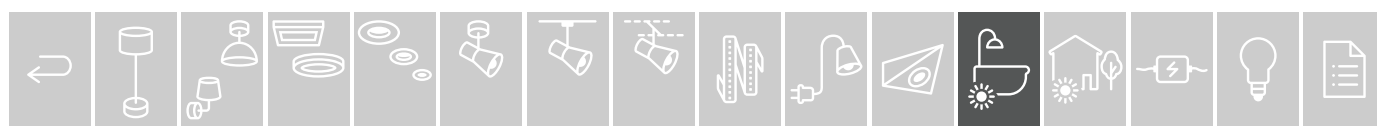



**Mizar**

incl. 1x10,5 W  
1.400 lm, 3.000 K  
230 V  
⌀45 ⇄630 ⌀82 mm  
EAN 4000870 797167  
**797.16**



- 🌀 Chrom/Weiß 🗪 Metall/Acryl
- 🌀 Chrome/Blanc 🗪 Métal/Acryl
- 🌀 Chroom/Wit 🗪 Metaal/Acryl



**Orgon**

incl. 1x7,5 W  
980 lm, 3.000 K  
230 V  
⌀60 ⇄440 ⌀82 mm  
EAN 4000870 797129  
**797.12**



**Orgon**

incl. 1x10,5 W  
1.400 lm, 3.000 K  
230 V  
⌀60 ⇄700 ⌀82 mm  
EAN 4000870 797136  
**797.13**



- 🌀 Chrom/Weiß 🗪 Metall/Acryl
- 🌀 Chrome/Blanc 🗪 Métal/Acryl
- 🌀 Chroom/Wit 🗪 Metaal/Acryl



**Quasar**

incl. 1x7,5 W  
980 lm, 3.000 K  
230 V  
⌀45 ⇄440 ⌀60 mm  
EAN 4000870 797143  
**797.14**



**Quasar**

incl. 1x10,5 W  
1.400 lm, 3.000 K  
230 V  
⌀45 ⇄700 ⌀60 mm  
EAN 4000870 797150  
**797.15**



- 🌀 Chrom/Weiß 🗪 Metall/Acryl
- 🌀 Chrome/Blanc 🗪 Métal/Acryl
- 🌀 Chroom/Wit 🗪 Metaal/Acryl





**Bela**

incl. 1x5,7 W  
 260 lm, 3.000 K  
 230 V, incl.  $\pm$ 8,4 VA  
 $\varnothing$ 230  $\leftrightarrow$ 230  $\nabla$ 295 mm  
 EAN 4000870 704684  
**704.68**



- 🔗 Chrom/Weiß/Spiegel  $\boxtimes$  Metall/Acryl
- 🔗 Chrome/Blanc/Miroir  $\boxtimes$  Métal/Acryl
- 🔗 Chroom/Wit/Spiegel  $\boxtimes$  Metaal/Acryl



**Mirror Zylindro**

incl. 1x3 W  
 120 lm, 2.700 K  
 $\sphericalangle$  60°  
 230 V, incl.  $\pm$ 3 VA  
 $\varnothing$ 260  $\leftrightarrow$ 80  $\nabla$ 235 mm  
 EAN 4000870 990681  
**990.68**



- 🔗 Chrom  $\boxtimes$  Metall
- 🔗 Chrome  $\boxtimes$  Métal
- 🔗 Chroom  $\boxtimes$  Metaal



**Galeria Double Hook**

incl. 2x3,2 W  
 2x378 lm, 2.700 K  
 $\sphericalangle$  100°  
 230 V  
 $\varnothing$ 80  $\leftrightarrow$ 300  $\nabla$ 110 mm  
 EAN 4000870 993859  
**993.85**

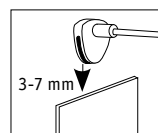

- 🔗 Chrom  $\boxtimes$  Metall
- 🔗 Chrome  $\boxtimes$  Métal
- 🔗 Chroom  $\boxtimes$  Metaal

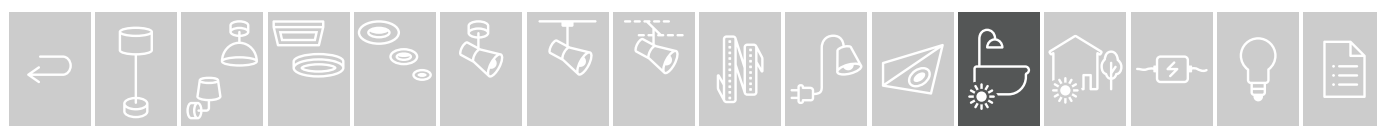



**Mintaka**

max. 20 W, GU10  
230 V  
⌀38 ↔56 ⌀120 mm  
EAN 4000870 708804  
**708.80**

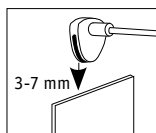

- ☞ Chrom ☐ Metall
- ☞ Chrome ☐ Métal
- ☞ Chroom ☐ Metaal



**Mirror Simple**

incl. 1×5,3 W, GU10  
345 lm, 2.700 K  
230 V  
⌀60 ø51 ↔30 ⌀100 mm  
EAN 4000870 999059  
**999.05**

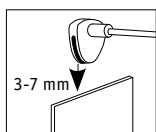

- ☞ Eisen gebürstet ☐ Metall
- ☞ Acier brossé ☐ Métal
- ☞ Staal geborsteld ☐ Metaal



**Becrux**

incl. 1×4 W  
460 lm, 3.000 K  
230 V  
⌀93 ↔93 ⌀140 mm  
EAN 4000870 708811  
**708.81**

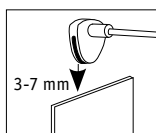

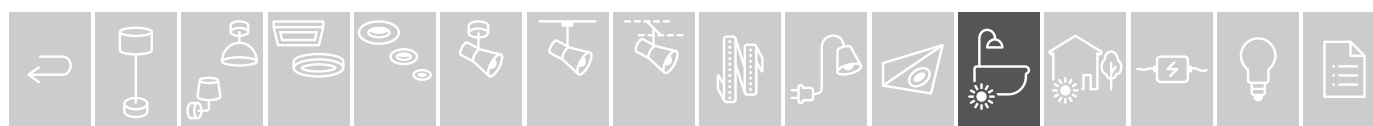

- ☞ Chrom ☐ Metall/Kunststoff
- ☞ Chrome ☐ Métal/Matière plastique
- ☞ Chroom ☐ Metaal/Kunststof





Perfect match  
 = 416

-  Chrom  Metall
-  Chrome  Métal
-  Chroom  Metaal



**Mirror Regula**

max. 3x40 W, E14  
 230 V  
 ⌀75 ⇄420 ⌀50 mm  
 EAN 4000870 996799  
**996.79**



**Mirror Regula**

max. 5x40 W, E14  
 230 V  
 ⌀75 ⇄650 ⌀50 mm  
 EAN 4000870 996805  
**996.80**

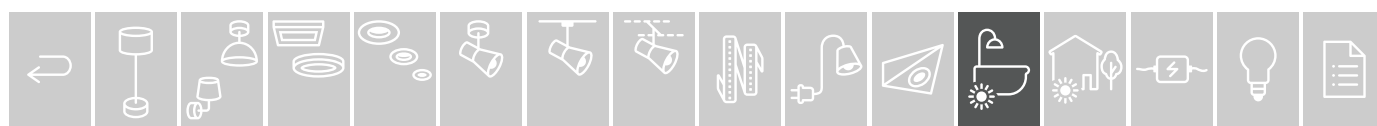



⚙️ Weiß/Chrom 📏 Metall  
 ⚙️ Blanc/Chrome 📏 Métal  
 ⚙️ Wit/Chroom 📏 Metaal



**Zyli**

max. 10W, GU10  
 230V  
 ⚙️ 110 ⌀100 mm  
 EAN 4000870 667101  
**667.10**



**Zyli**

max. 2x10W, GU10  
 230V  
 ⚙️ 110 ⇄400 ↗70 mm  
 EAN 4000870 667118  
**667.11**



**Zyli**

max. 3x10W, GU10  
 230V  
 ⚙️ 110 ⇄600 ↗70 mm  
 EAN 4000870 667132  
**667.13**



**Zyli**

max. 3x10W, GU10  
 230V  
 ⚙️ 110 ⌀250 mm  
 EAN 4000870 667125  
**667.12**

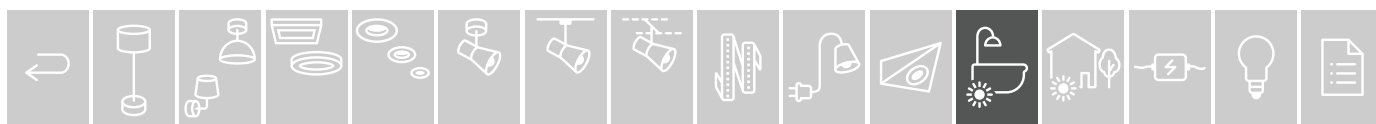



Wei/Chrom Metall  
Blanc/Chrome Mtal  
Wit/Chroom Metaal



**Tube**

max. 10 W, GU10  
230 V  
138 100 94 mm  
EAN 4000870 667170  
**667.17**



**Tube**

max. 2x10 W, GU10  
230 V  
94 350 65 mm  
EAN 4000870 667187  
**667.18**



**Tube**

max. 3x10 W, GU10  
230 V  
94 250 mm  
EAN 4000870 667194  
**667.19**



Anthrazit/Chrom Metall  
Anthracite/Chrome Mtal  
Antraciet/Chroom Metaal



Perfect match

424, 401



**Carolina**

max. 10 W, GU10  
230 V  
110 80 mm  
EAN 4000870 667507  
**667.50**



**Carolina**

max. 2x10 W, GU10  
230 V  
128 264 80 mm  
EAN 4000870 667514  
**667.51**



**Carolina**

max. 3x10 W, GU10  
230 V  
110 200 mm  
EAN 4000870 667521  
**667.52**

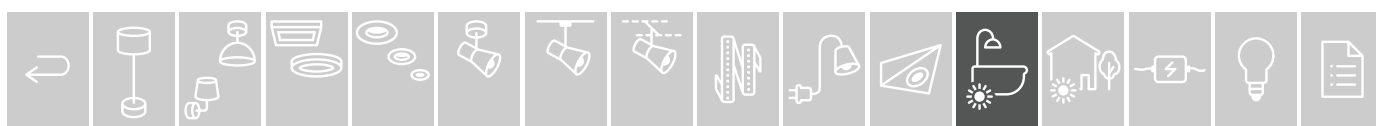

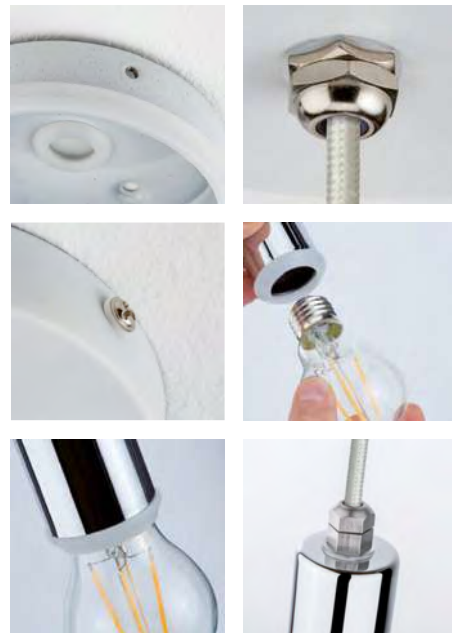

Perfect match

☐ = 412-419



**Larus**

max. 20W, E27  
230V  
±159 cm ø110 mm  
EAN 4000870 797532  
**797.53**

- ☞ Chrom ☐ Metall
- ☞ Chrome ☐ Métal
- ☞ Chrom ☐ Metaal



**Larus**

max. 20W, E27  
230V  
±159 cm ø110 mm  
EAN 4000870 797549  
**797.54**

- ☞ Schwarzchrom ☐ Metall
- ☞ Chrome noir ☐ Métal
- ☞ Black chrom ☐ Metaal



**Ketil**

max. 20W, E27  
230V  
±200 cm ø92 mm  
EAN 4000870 503461  
**503.46**

- ☞ Schwarz ☐ Silikon/Kunststoff
- ☞ Noir ☐ Silicone/Matière plastique
- ☞ Zwart ☐ Silicon/Kunststof

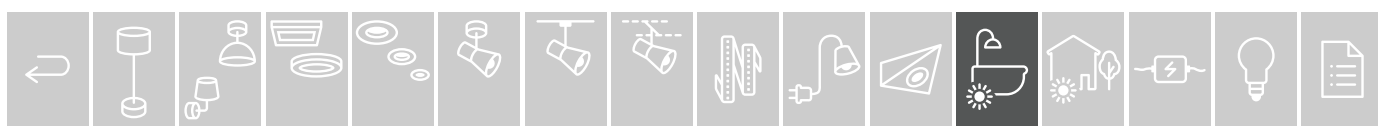





Textilkabel  
Câble en textile  
Textielkabel



Perfect match

☑ = 409-412

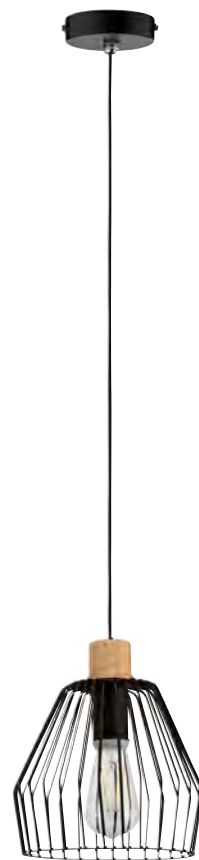

**Globe**

max. 20W, E27  
230V  
110 cm ø200 mm  
EAN 4000870 708958  
**708.95**



- ☞ Satin/Chrom ☒ Glas/Metall
- ☞ Satiné/Chrome ☒ Verre/Métal
- ☞ Satijn/Chroom ☒ Glas/Metaal

**Verve**

max. 20W, E27  
230V  
110 cm ø200 mm  
EAN 4000870 708903  
**708.90**



- ☞ Grau/Chrom ☒ Beton/Metall
- ☞ Gris/Chrome ☒ Béton/Métal
- ☞ Grijs/Chroom ☒ Beton/Metaal

**Cameo**

max. 20W, E27  
230V  
110 cm ø220 mm  
EAN 4000870 708910  
**708.91**



- ☞ Schwarz/Holz ☒ Metall/Holz
- ☞ Noir/Bois ☒ Métal/Bois
- ☞ Zwart/Hout ☒ Metaal/Hout



# Outdoor

322 Plug & Shine

346 Park + Light

350 House

365 Solar

383 Mobile

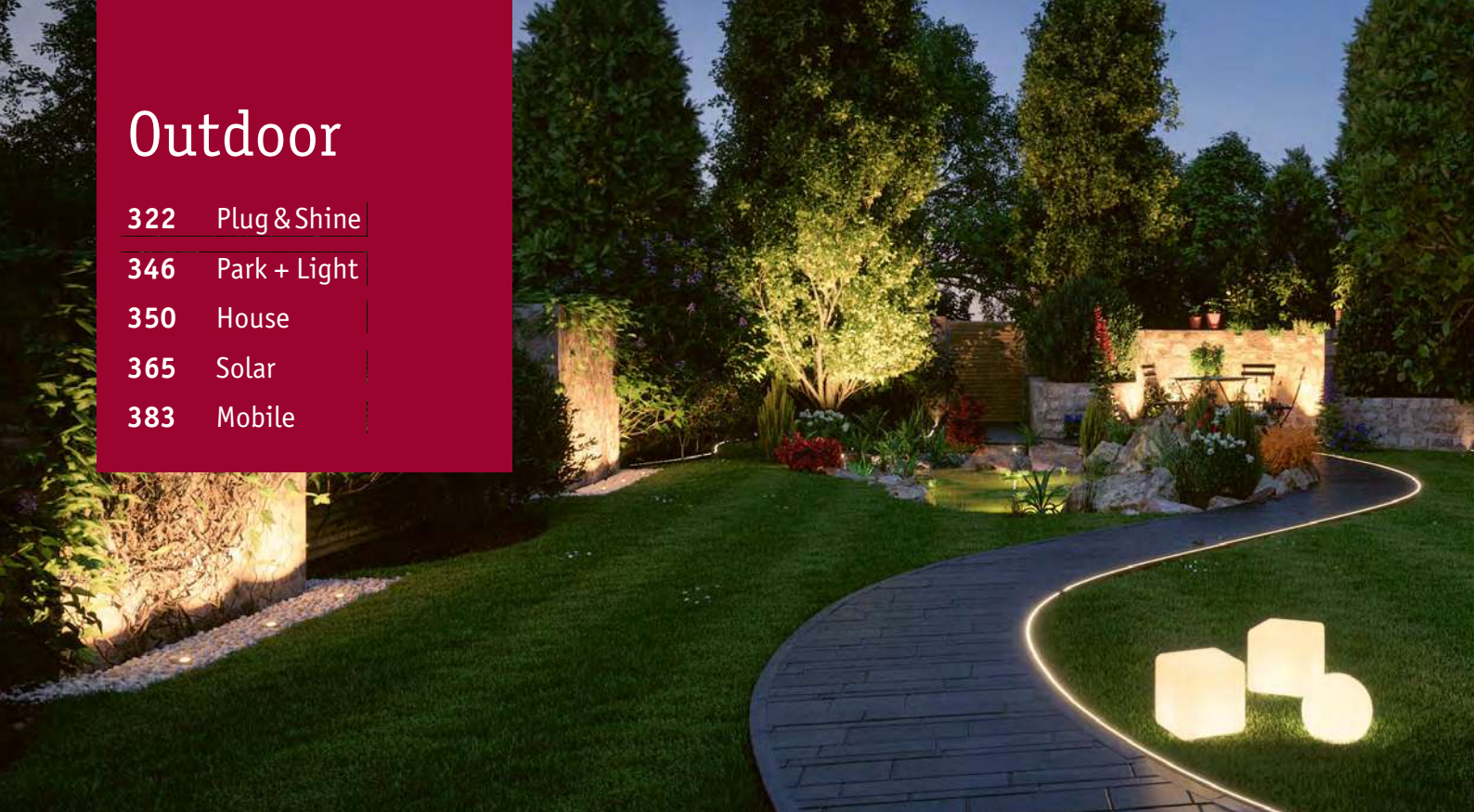

📖 = 346

## Park + Light

DE Das innovative 12V-Lichtsystem für Carports  
FR Le système d'éclairage 12 V innovant pour les carports  
NL Het innovatieve 12V-lichtsysteem voor carports



📖 = 365

## Solar

DE Sonnenbetriebene Leuchten für draußen, unabhängig vom Stromanschluss  
FR Luminaire à énergie solaire pour l'extérieur, non dépendant de l'alimentation électrique  
NL Lampen op zonne-energie voor buiten, onafhankelijk van een stroomaansluiting

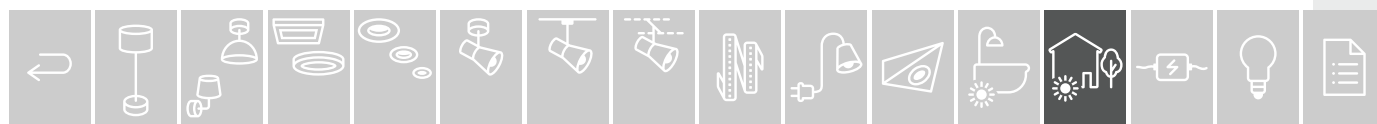

## Plug & Shine



DE 24V-LED-Lichtsystem für faszinierendes Licht im Garten und auf der Terrasse

FR Système d'éclairage LED 24 V pour un éclairage fascinant du jardin et de la terrasse

NL 24V-LED-lichtsysteem voor fascinerend licht in de tuin en op het terras

☞=322



☞=350

## House

DE Die zuverlässigen 230V-Leuchten für Licht rund ums Haus

FR Les luminaires 230 V fiables pour un éclairage tout autour de la maison

NL De betrouwbare 230V-armaturen voor licht rondom het huis



## Mobile

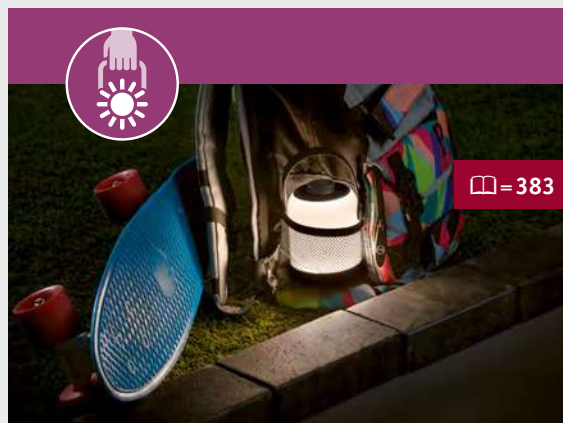

☞=383

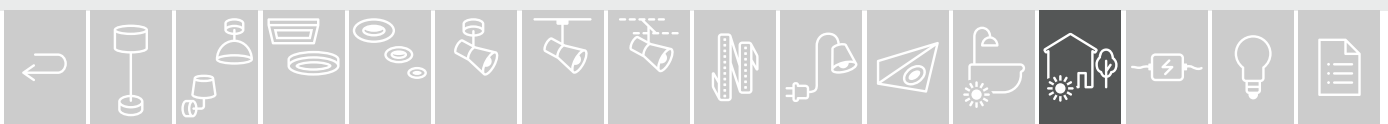





- ▶ Starter-Sets für den Einstieg in das System inkl. 3 Leuchten, 5 Meter Kabel mit 4 Ausgängen und einem Trafo
- ▶ Erweiterbar
- ▶ Stufenlose Lichtfarbensteuerung per Zigbee-Fernbedienung, App oder Sprache
- ▶ Ideal zum stimmungsvollen Anstrahlen von Pflanzen oder Gegenständen
- ▶ Kits de démarrage : comprend 3 luminaires, 5 m de câble avec 4 sorties et un transformateur
- ▶ Extensible
- ▶ Contrôle en continu de la température de couleur par télécommande Zigbee, application ou commande vocale
- ▶ Idéal pour un éclairage stylé de plantes ou d'objets
- ▶ Starter-Sets voor de instap in het systeem incl. 3 lampen, 5 meter kabel met 4 uitgangen en een trafo
- ▶ Uitbreidbaar
- ▶ Traploze lichtkleurbesturing met Zigbee-afstandsbediening, app of spraak
- ▶ Ideaal voor het sfeervol verlichten van planten en voorwerpen



#### Plug & Shine Spot Pike Starter-Set

incl. 3×4,2W  
 3×330 lm, 3.000 - 6.500 K  
 24V, incl. ⚡ 21 VA  
 ⚙ 313 ⌀50 ↗82 mm  
 EAN 4000870 942840  
**942.84**



- 🔗 Anthrazit 🧱 Kunststoff
- 🔗 Anthracite 🧱 Matière plastique
- 🔗 Antraciet 🧱 Kunststof



- ▶ Mit 45° Ausstrahlwinkel ideal zum Anstrahlen von Pflanzen oder Gegenständen
- ▶ Erdspeiß für die flexible Installation in jedem Garten
- ▶ Avec un angle de rayonnement 45°, ils conviennent parfaitement à l'éclairage de plantes ou d'objets
- ▶ Piquet à planter pour un positionnement flexible dans le jardin
- ▶ Dankzij uitstraalhoek van 45° ideaal voor het verlichten van planten en voorwerpen
- ▶ Grondpen voor die flexibele installatie in elke tuin



#### Plug & Shine Spot Pike Starter-Set

incl. 3×3W  
 3×370 lm, 3.000 K  
 < 45°  
 230/24V, incl. ⚡ 21 VA  
 ⚙ 313 mm ⌀50 mm ↗82 mm ↔5 m  
 EAN 4000870 942420  
**942.42**



- 🔗 Anthrazit 🧱 Kunststoff
- 🔗 Anthracite 🧱 Matière plastique
- 🔗 Antraciet 🧱 Kunststof





- ▶ Starter-Sets für den Einstieg in das System inkl. 3 Leuchten, 5 Meter Kabel mit 4 Ausgängen und einem Trafo für Erweiterungsmöglichkeiten
- ▶ Erweiterbar

- ▶ Kits de démarrage : comprend 3 luminaires, 5m de câble avec 4 sorties et un transformateur pour d'éventuelles extensions
- ▶ Extensible

- ▶ Starter-Sets voor de instap in het systeem incl. 3 lampen, 5 meter kabel met 4 uitgangen en een trafo voor uitbreidingsmogelijkheden
- ▶ Uitbreidbaar



**Plug & Shine Spot Classic Starter-Set**

incl. 3x5,1 W  
 3x310 lm, 3.000 K  
 < 32°  
 230/24 V, incl. ⚡ 75 VA  
 ⚡ 265 mm ø88 mm ↔ 5 m  
 EAN 4000870 942864  
**942.86**



- 🔗 Anthrazit 🏠 Metall
- 🔗 Anthracite 🏠 Métal
- 🔗 Antraciet 🏠 Metaal





- ▶ Starter-Sets für den Einstieg in das System inkl. 3 Leuchten, 5 Meter Kabel mit 4 Ausgängen und einem Trafo für Erweiterungsmöglichkeiten
- ▶ Erweiterbar

- ▶ Kits de démarrage : comprend 3 luminaires, 5m de câble avec 4 sorties et un transformateur pour d'éventuelles extensions
- ▶ Extensible

- ▶ Starter-Sets voor de instap in het systeem incl. 3 lampen, 5 meter kabel met 4 uitgangen en een trafo voor uitbreidingsmogelijkheden
- ▶ Uitbreidbaar



**Plug & Shine Spot Sting Starter-Set**

incl. 3x6,4 W  
 3x520 lm, 3.000 K  
 < 100°  
 230/24 V, incl. 75 VA  
 ∅290 mm ø52 mm ↔5 m  
 EAN 4000870 936962  
**936.96**



- ▶ Anthrazit Alu
- ▶ Anthracite Alu
- ▶ Antraciet Alu

- ▶ Erweiterungs-Sets für den einfachen Ausbau des Systems, inkl. 3 Leuchten und 5 Meter Kabel mit 4 Ausgängen

- ▶ Kits d'extension du système : comprend 3 luminaires, 5 m de câble avec 4 sorties

- ▶ Uitbreidingssets voor de eenvoudige uitbreiding van het systeem incl. 3 lampen en 5 meter kabel met 4 uitgangen



**Plug & Shine Spot Sting Extension-Set**

incl. 3x6,4 W  
 3x520 lm, 3.000 K  
 < 100°  
 24 V  
 EAN 4000870 936894  
**936.89**



- ▶ Anthrazit Alu
- ▶ Anthracite Alu
- ▶ Antraciet Alu





- ▶ Starter-Sets für den Einstieg in das System inkl. 3 Leuchten, 5 Meter Kabel mit 4 Ausgängen und einem Trafo für Erweiterungsmöglichkeiten
- ▶ Erweiterbar

- ▶ Kits de démarrage : comprend 3 luminaires, 5m de câble avec 4 sorties et un transformateur pour d'éventuelles extensions
- ▶ Extensible

- ▶ Starter-Sets voor de instap in het systeem incl. 3 lampen, 5 meter kabel met 4 uitgangen en een trafo voor uitbreidingsmogelijkheden
- ▶ Uitbreidbaar



#### Plug & Shine Spot Plantini Starter-Set

incl. 3×2,5 W  
3×200 lm, 3.000 K  
↙ 45°  
230/24 V, incl. ⚡ 21 VA  
↕ 223 mm ø 21 mm ↗ 77 mm ↔ 5 m  
EAN 4000870 941546  
**941.54**



- 🔗 Anthrazit 🏠 Alu
- 🔗 Anthracite 🏠 Alu
- 🔗 Antraciet 🏠 Alu

- ▶ Erweiterungs-Sets für den einfachen Ausbau des Systems, inkl. 3 Leuchten und 5 Meter Kabel mit 4 Ausgängen

- ▶ Kits d'extension du système : comprend 3 luminaires, 5 m de câble avec 4 sorties

- ▶ Uitbreidingssets voor de eenvoudige uitbreiding van het systeem incl. 3 lampen en 5 meter kabel met 4 uitgangen



#### Plug & Shine Spot Plantini Extension-Set

incl. 3×2,5 W  
3×200 lm, 3.000 K  
↙ 45°  
24 V  
↕ 223 mm ø 21 mm ↗ 77 mm ↔ 5 m  
EAN 4000870 941560  
**941.56**



- 🔗 Anthrazit 🏠 Alu
- 🔗 Anthracite 🏠 Alu
- 🔗 Antraciet 🏠 Alu

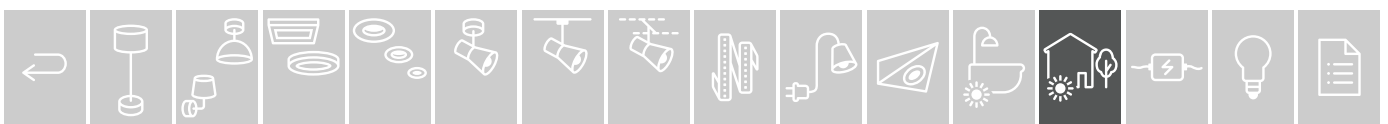





- RGBW
- tunable white
- smart controllable
- zigbee

- ▶ Starter-Sets für den Einstieg in das System inkl. 3 Leuchten, 5 Meter Kabel mit 4 Ausgängen und einem Trafo
- ▶ Erweiterbar
- ▶ Stufenlose Lichtfarbensteuerung per Zigbee-Fernbedienung, App oder Sprache
- ▶ Kits de démarrage : comprend 3 luminaires, 5 m de câble avec 4 sorties et un transformateur
- ▶ Extensible
- ▶ Contrôle en continu de la température de couleur par télécommande Zigbee, application ou commande vocale
- ▶ Starter-Sets voor de instap in het systeem incl. 3 lampen, 5 meter kabel met 4 uitgangen en een trafo
- ▶ Uitbreidbaar
- ▶ Traploze lichtkleurbesturing met Zigbee-afstandsbediening, app of spraak



**Plug & Shine Floor Starter-Set**  
 incl. 3x3,7W  
 3x350 lm, 3.000 - 6.500 K  
 <math>\sphericalangle</math> 93°  
 230/24V  
 ∅92 ∅98 mm  
 EAN 4000870 942758  
**942.75**

- RGBW
- tunable white
- IP44
- IP65
- rostfrei
- alu
- 

- Silber Edelstahl/Kunststoff
- Argent Acier inoxydable/Matière plastique
- Zilver edelstaal/Kunststof



- 
- 
- Kg 100

- ▶ Starter-Sets für den Einstieg in das System inkl. 3 Leuchten, 5 Meter Kabel mit 4 Ausgängen und einem Trafo für Erweiterungsmöglichkeiten
- ▶ Erweiterbar
- ▶ Kits de démarrage : comprend 3 luminaires, 5m de câble avec 4 sorties et un transformateur pour d'éventuelles extensions
- ▶ Extensible
- ▶ Starter-Sets voor de instap in het systeem incl. 3 lampen, 5 meter kabel met 4 uitgangen en een trafo voor uitbreidingsmogelijkheden
- ▶ Uitbreidbaar



**Plug & Shine Floor Starter-Set**  
 incl. 3x1,4W  
 3x100 lm, 3.000 K  
 <math>\sphericalangle</math> 90°  
 230/24V, incl. 21VA  
 ∅30 mm ∅70 mm ∅5 m  
 EAN 4000870 936924  
**936.92**

- IP44
- IP67
- rostfrei
- 

- Silber Edelstahl/Kunststoff
- Argent Acier inoxydable/Matière plastique
- Zilver edelstaal/Kunststof





- ▶ Starter-Sets für den Einstieg in das System inkl. 3 Leuchten, 5 Meter Kabel mit 4 Ausgängen und einem Trafo für Erweiterungsmöglichkeiten
- ▶ Erweiterbar

- ▶ Kits de démarrage : comprend 3 luminaires, 5m de câble avec 4 sorties et un transformateur pour d'éventuelles extensions
- ▶ Extensible

- ▶ Starter-Sets voor de instap in het systeem incl. 3 lampen, 5 meter kabel met 4 uitgangen en een trafo voor uitbreidingsmogelijkheden
- ▶ Uitbreidbaar



#### Plug & Shine Floor Mini Starter-Set

incl. 3x1,8W  
3x95 lm, 3.000 K  
∠ 95°  
230/24 V, incl. ⚡ 21 VA  
∅90 ø55 mm  
EAN 4000870 936979  
**936.97**



🔗 Silber 🗍 Edeltahl/Kunststoff  
🔗 Argent 🗍 Acier inoxydable/  
Matière plastique  
🔗 Zilver 🗍 edelstaal/Kunststof

- ▶ Erweiterungs-Sets für den einfachen Ausbau des Systems, inkl. 3 Leuchten und 5 Meter Kabel mit 4 Ausgängen

- ▶ Kits d'extension du système : comprend 3 luminaires, 5 m de câble avec 4 sorties

- ▶ Uitbreidingssets voor de eenvoudige uitbreiding van het systeem incl. 3 lampen en 5 meter kabel met 4 uitgangen



#### Plug & Shine Floor Mini Extension-Set

incl. 3x1,8W  
3x95 lm, 3.000 K  
∠ 95°  
24 V  
∅90 mm ø55 mm ↔5 m  
EAN 4000870 939499  
**939.49**



🔗 Silber 🗍 Edeltahl/Kunststoff  
🔗 Argent 🗍 Acier inoxydable/  
Matière plastique  
🔗 Zilver 🗍 edelstaal/Kunststof

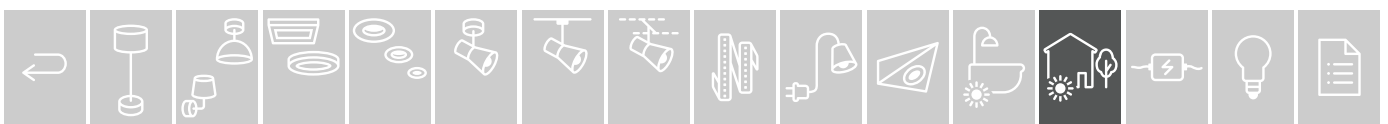



- ▶ Starter-Set incl. 5 Leuchten und Trafo
- ▶ Geeignet für Holzterrassen

- ▶ Kit de démarrage inclus 5 luminaires et transfo
- ▶ Convient aux terrasses en bois

- ▶ Starter-Set incl. 5 armaturen en trafo
- ▶ Geschikt voor terrassen van hout



**Plug & Shine MicroPen II Starter-Set**

incl. 5x0,22 W  
 5x3 lm, 3.000 K  
 <math>\sphericalangle</math> 22°  
 230/24 V, incl. ⚡ 21 VA  
 ø15 mm  
 EAN 4000870 936955  
**936.95**



- 🔗 Silber 🏠 Edelstahl
- 🔗 Argent 🏠 Acier inoxydable
- 🔗 Zilver 🏠 edelstaal

- ▶ Erweiterungs-Sets für den einfachen Ausbau des Systems, inkl. 5 Leuchten

- ▶ Kits d'extension du système : comprend 5 luminaires

- ▶ Uitbreidingssets voor de eenvoudige uitbreiding van het systeem incl. 5 lampen



**Plug & Shine MicroPen II Extension-Set**

incl. 5x0,22 W  
 5x3 lm, 3.000 K  
 <math>\sphericalangle</math> 22°  
 24 V  
 ø15 mm  
 EAN 4000870 936948  
**936.94**



- 🔗 Silber 🏠 Edelstahl
- 🔗 Argent 🏠 Acier inoxydable
- 🔗 Zilver 🏠 edelstaal

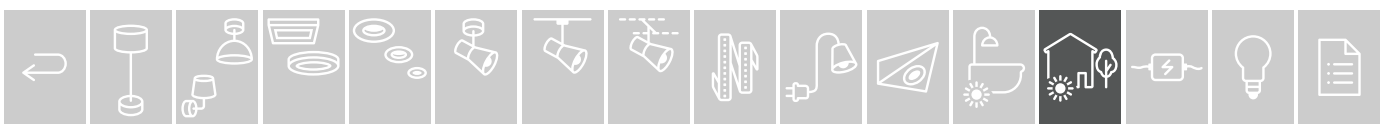



- ▶ Ideal zum stimmungsvollen Anstrahlen von Pflanzen oder Gegenständen
- ▶ Erdspieß für die flexible Installation in jedem Garten
- ▶ Stufenlose Lichtfarbensteuerung per Zigbee-Fernbedienung, App oder Sprache
- ▶ Idéal pour un éclairage stylé de plantes ou d'objets
- ▶ Piquet à planter pour un positionnement flexible dans le jardin
- ▶ Contrôle en continu de la température de couleur par télécommande Zigbee, application ou commande vocale
- ▶ Ideaal voor het sfeervol verlichten van planten en voorwerpen
- ▶ Grondpen voor die flexibele installatie in elke tuin
- ▶ Traploze lichtkleurbesturing met Zigbee-afstandsbediening, app of spraak

**Plug & Shine Spot Pike**

incl. 1x4,2 W  
330 lm, 3.000 – 6.500 K  
24 V  
⌀313 ø50 ⤴82 mm  
EAN 4000870 942833  
**942.83**

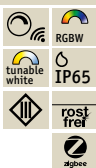

- 🔗 Anthrazit Kunststoff
- 🔗 Anthracite Matière plastique
- 🔗 Antraciet Kunststof



- ▶ Mit 45° Ausstrahlwinkel ideal zum Anstrahlen von Pflanzen oder Gegenständen
- ▶ Erdspieß für die flexible Installation in jedem Garten
- ▶ Avec un angle de rayonnement 45°, ils conviennent parfaitement à l'éclairage de plantes ou d'objets
- ▶ Piquet à planter pour un positionnement flexible dans le jardin
- ▶ Dankzij uitstraalhoek van 45° ideaal voor het verlichten van planten en voorwerpen
- ▶ Grondpen voor die flexibele installatie in elke tuin

**Plug & Shine Spot Pike**

incl. 1x2,3 W  
370 lm, 3.000 K  
⤴ 45°  
24 V  
⌀313 ø50 ⤴82 mm  
EAN 4000870 942413  
**942.41**



- 🔗 Anthrazit Kunststoff
- 🔗 Anthracite Matière plastique
- 🔗 Antraciet Kunststof

- ▶ Ideal für die Ausleuchtung von Büschen und Beeten
- ▶ Convient parfaitement à l'éclairage d'arbustes et de massifs
- ▶ Ideaal voor het verlichten van struiken en perken

**Plug & Shine Spot Sting**

incl. 1x6,4 W  
520 lm, 3.000 K  
⤴ 100°  
24 V  
⌀290 ø52 mm  
EAN 4000870 939345  
**939.34**



- 🔗 Anthrazit Alu
- 🔗 Anthracite Alu
- 🔗 Antraciet Alu

**Plug & Shine Spot Classic**

incl. 1x5,1 W  
310 lm, 3.000 K  
⤴ 32°  
24 V  
⌀265 ø88 mm  
EAN 4000870 942857  
**942.85**



- 🔗 Anthrazit Metall
- 🔗 Anthracite Métal
- 🔗 Antraciet Metaal

- ▶ Kleiner flexibler Gartenspot für Lichtakzente in Beeten oder Kübeln
- ▶ Petit spot de jardin flexible pour écl. massifs ou jardinières
- ▶ Kleine flexibele tuinspot voor lichtaccenten in perken of plantenbakken

**Plug & Shine Spot Plantini**

incl. 1x1,4 W  
200 lm, 3.000 K  
⤴ 45°  
24 V  
⌀223 ø21 ⤴77 mm  
EAN 4000870 939970  
**939.97**



- 🔗 Anthrazit Alu
- 🔗 Anthracite Alu
- 🔗 Antraciet Alu





- ▶ Unterwasser-Spot IP68 für Teiche – Installation unter Wasser durch Metallteller

- ▶ Spot submersible IP68 pour bassins – Installation immergée via partie métallique

- ▶ Onderwaterspot IP68 voor vijvers – installatie onder water door metalen schaal



**Plug & Shine Underwater Spot**

incl. 1x2,8 W  
400 lm, 3.000 K  
◄ 25°  
24 V  
⌀120 ø200 mm  
EAN 4000870 942093  
**942.09**

- 🌀 Schwarz 田 Alu
- 🌀 Noir 田 Alu
- 🌀 Zwart 田 Alu

IP68

rostfrei

- ▶ Fluter Plug & Shine für lichtstarke Beleuchtung von Objekten oder Fassaden
- ▶ Inklusive Montagespieß für die flexible Anordnung

- ▶ Projecteur Plug & Shine pour un éclairage puissant des objets et des façades
- ▶ Piquet de fixation inclus pour un aménagement flexible

- ▶ Floodlight Plug & Shine voor lichtsterke verlichting van objecten of gevels
- ▶ Inclusief montagespies voor flexibele plaatsing



**Plug & Shine Flood Spot**

incl. 1x6,8 W  
650 lm, 3.000 K  
24 V  
⌀103 ⇄103 ⚡23 mm  
EAN 4000870 945742  
**945.74 new**

- 🌀 Schwarz 田 Aluminium
- 🌀 Noir 田 Aluminium
- 🌀 Zwart 田 Aluminium

IP65

rostfrei



**Plug & Shine Flood Spot**

incl. 1x15,5 W  
1.700 lm, 3.000 K  
24 V  
⌀145 ⇄160 ⚡26 mm  
EAN 4000870 945759  
**945.75 new**

- 🌀 Schwarz 田 Aluminium
- 🌀 Noir 田 Aluminium
- 🌀 Zwart 田 Aluminium

IP65

rostfrei

- ▶ Plug & Shine Bodeneinbauleuchte für die effiziente Beleuchtung von Pflanzen und Objekten vom Boden aus
- ▶ Stufenlose Lichtfarbensteuerung per Zigbee-Fernbedienung, App oder Sprache

- ▶ Encastrés de sol Plug & Shine pour l'éclairage efficace des plantes et les objets depuis le sol
- ▶ Contrôle en continu de la température de couleur par télécommande Zigbee, application ou commande vocale

- ▶ Plug & Shine grondinbouwlampen voor de efficiënte verlichting van planten en voorwerpen vanaf de grond
- ▶ Traploze lichtkleurbesturing met Zigbee-afstandsbediening, app of spraak



**Plug & Shine Floor**

incl. 1x3,7 W  
350 lm, 3.000 - 6.500 K  
◄ 93°  
24 V  
⌀92 ø96 mm  
EAN 4000870 942741  
**942.74**

- 🌀 Silber 田 Edelstahl/Kunststoff
- 🌀 Argent 田 Acier inoxydable/Matière plastique
- 🌀 Zilver 田 edelstaal/Kunststof

RGBW

tunable white

IP65

rostfrei

zigbee

RGBW

tunable white

smart controllable

zigbee

- ▶ Einfache Montage durch mitgelieferte Einbauhülse
- ▶ Geeignet für Terrasse und Erdreich

- ▶ Pose simple par manchon fourni
- ▶ Convient aux terrasses et à la terre

- ▶ Eenvoudige montage door bijgeleverde inbouwhuls
- ▶ Geschikt voor terras en aardrijk



**Plug & Shine Floor Mini**

incl. 1x1,8 W  
95 lm, 3.000 K  
◄ 95°  
24 V  
⌀90 ø55 mm  
EAN 4000870 939512  
**939.51**

- 🌀 Silber 田 Edelstahl/Kunststoff
- 🌀 Argent 田 Acier inoxydable/Matière plastique
- 🌀 Zilver 田 edelstaal/Kunststof

IP65

rostfrei

500 Kg





- ▶ Einfache Montage durch Befestigungsklammern
- ▶ Geeignet für Holz- und Steinterrassen

- ▶ Pose simple par clips de fixation
- ▶ Convient aux terrasses en bois ou en pierre

- ▶ Eenvoudige montage door bevestigingsklampen
- ▶ Geschikt voor terrassen van hout en steen

**Plug & Shine Floor**

incl. 1x1,4 W  
100 lm, 3.000 K  
∠ 90°  
24 V  
∅30 ø70 mm  
EAN 4000870 939536  
**939.53**

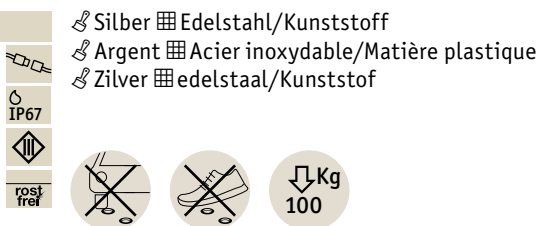

- ▶ Ideal für die Ausleuchtung von breiteren Bäumen oder Fassaden
- ▶ Gezielte Ausleuchtung durch definierten Ausstrahlwinkel
- ▶ Perfekte Ausleuchtung, da schwenkbar
- ▶ Entblendet durch versenkte Lichtquelle
- ▶ Ungehindertes Rasenmähen

- ▶ Convient parfaitement à l'éclairage d'arbres ou de façades
- ▶ Éclairage ciblé grâce à l'angle de rayonnement prédéfini
- ▶ Éclairage parfait car orientable
- ▶ Source lumineuse encastrée non éblouissante
- ▶ Tondre sans obstacle

- ▶ Ideaal voor het verlichten van bomen of gevels
- ▶ Gerichte verlichting door gedefinieerde uitstralhoek
- ▶ Perfecte verlichting, aangezien zwenkbaar
- ▶ Niet-verblindend dankzij verzonken lichtbron
- ▶ Ongehinderd grasmaaien

**Plug & Shine Floor**

incl. 1x4,5 W  
609 lm, 3.000 K  
∠ 38°  
24 V  
∅150 ø140 mm  
EAN 4000870 939086  
**939.08**

☞ Silber ☒ Metall  
☞ Argent ☒ Métal  
☞ Zilver ☒ Metaal

**Plug & Shine Floor**

incl. 1x4,5 W  
609 lm, 3.000 K  
∠ 20°  
24 V  
∅150 ø140 mm  
EAN 4000870 939079  
**939.07**

☞ Silber ☒ Metall  
☞ Argent ☒ Métal  
☞ Zilver ☒ Metaal



- ▶ Plug & Shine Bodeneinbauleuchte für die effiziente Beleuchtung von Pflanzen und Objekten vom Boden aus

- ▶ Encastrés de sol Plug & Shine pour l'éclairage efficace des plantes et les objets depuis le sol

- ▶ Plug & Shine grondinbouwlampen voor de efficiënte verlichting van planten en voorwerpen vanaf de grond

**Plug & Shine Floor**

incl. 1x3,8 W  
450 lm, 3.000 K  
24 V  
∅91 ø98 mm  
EAN 4000870 942284  
**942.28**

☞ Edelstahl ☒ Metall/Kunststoff  
☞ Acier inoxydable ☒ Métal/Matière plastique  
☞ Edelstaal ☒ Metaal/Kunststof

**Plug & Shine Floor**

incl. 1x3,8 W  
450 lm, 3.000 K  
24 V  
∅91 ∅100 ∅100 mm  
EAN 4000870 942277  
**942.27**

☞ Edelstahl ☒ Metall/Kunststoff  
☞ Acier inoxydable ☒ Métal/Matière plastique  
☞ Edelstaal ☒ Metaal/Kunststof

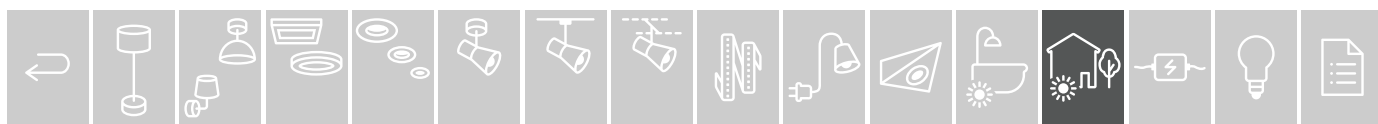



- ▶ Ideal für gleichmäßig breite lichtstarke Beleuchtung von Mauern, Hecken, Hauswänden und zur effektvollen Hervorhebung von Reliefs
- ▶ Entblendet durch versenkte Lichtquelle
- ▶ Ungehindertes Rasenmähen
- ▶ Convient parfaitement à l'éclairage puissant, large et homogène de murs, haies et façades ou pour la mise en évidence efficace des reliefs
- ▶ Source lumineuse encastrée non éblouissante
- ▶ Tondre sans obstacle
- ▶ Ideaal voor een gelijkmatig brede, lichtsterke verlichting van muren, hagen, gevels en voor een effectieve accentueren van reliëfs
- ▶ Niet-verblindend dankzij verzonken lichtbron
- ▶ Ongehinderd grasmaaien

**Plug & Shine Floor**

incl. 1x7,9 W

875 lm, 3.000 K

✗ 95°

24 V

⌈45 ⇔ 900 ⌋54 mm

EAN 4000870 939215

**939.21**



- 🔩 Anthrazit ㊦ Alu Druckguss
- 🔩 Anthracite ㊦ Alu moulé sous pression
- 🔩 Antraciet ㊦ Alu drukgegoten



- ▶ Ideal für gleichmäßig breite lichtstarke Beleuchtung von Mauern, Hecken, Hauswänden und zur effektvollen Hervorhebung von Reliefs
- ▶ Schwenkbar
- ▶ Rahmenlos verkettbar für gleichmäßige Ausleuchtung langer Flächen
- ▶ Convient parfaitement à l'éclairage puissant, large et homogène de murs, haies et façades ou pour la mise en évidence efficace des reliefs
- ▶ Orientable
- ▶ Combinable librement pour l'éclairage homogène de longues surfaces
- ▶ Ideaal voor een gelijkmatig brede, lichtsterke verlichting van muren, hagen, gevels en voor een effectieve accentueren van reliëfs
- ▶ Zwenkbaar
- ▶ Zonder frame verbindbaar voor gelijkmatige verlichting van lange oppervlakken

**Plug & Shine Floor**

incl. 1x8,1 W

875 lm, 3.000 K

✗ 115°

24 V

⌈58 ⇔ 856 ⌋52 mm

EAN 4000870 939222

**939.22**



- 🔩 Anthrazit ㊦ Alu Druckguss
- 🔩 Anthracite ㊦ Alu moulé sous pression
- 🔩 Antraciet ㊦ Alu drukgegoten

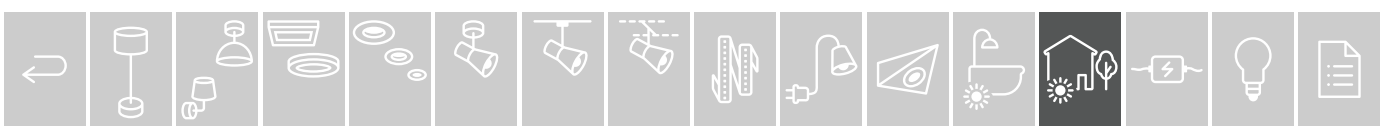



- ▶ Ideal zur Beleuchtung der Einfahrt
- ▶ Blendfrei durch effektvolles Streiflicht
- ▶ Extra schwere Qualität
- ▶ Befahrbar

- ▶ Idéal pour l'éclairage d'entrées
- ▶ Non éblouissant grâce à un bandeau lumineux raffiné
- ▶ Qualité extra robuste
- ▶ Carrossable

- ▶ Ideaal voor de verlichting van de inrit
- ▶ Niet-verblindend door effectvol scheinlicht
- ▶ Extra zware kwaliteit
- ▶ Overrijdbaar

**Plug & Shine Floor**

incl. 2x3,3W  
2x350 + 350lm, 3.000 K  
◄ 180°  
24V  
⌀32 ø160 mm  
EAN 4000870 939208  
**939.20**



- ☞ Anthrazit Alu Druckguss
- ☞ Anthracite Alu moulé sous pression
- ☞ Antraciet Alu drukgegoten



- ▶ Ideal für die Wegebeleuchtung ohne Blendung

- ▶ Convient parfaitement à l'éclairage non aveuglant d'allées

- ▶ Ideaal voor de padverlichting zonder te verblinden

**Plug & Shine Path**

incl. 2x3,3W  
2x350 + 350lm, 3.000 K  
◄ 180°  
24V  
⌀155 ø193 mm  
EAN 4000870 939178  
**939.17**



- ☞ Anthrazit Alu Druckguss
- ☞ Anthracite Alu moulé sous pression
- ☞ Antraciet Alu drukgegoten







► Zuverlässiger Poller mit hoher Lichtleistung

► Borne fiable à flux lumineux élevé

► Betrouwbare bolderlampen met hoge lichtopbrengst



**Plug & Shine Poller Plate**

incl. 1x6,1 W  
580 lm, 3.000 K  
24 V  
⌄600 ⌀159 mm  
EAN 4000870 943120  
**943.12**



- 🔗 Anthrazit 🧱 Kunststoff
- 🔗 Anthracite 🧱 Matière plastique
- 🔗 Antraciet 🧱 Kunststof



► Pollerleuchten klassisch mit dimmbaren warmweißen 24 V-Filament-Lampen  
► Rundumstrahlend für die Beleuchtung von Plätzen oder Beeten

► Bornes lumineuses classiques avec ampoules à filament de 24 V gradables en blanc chaud  
► Éclairage rayonnant à 360° pour l'éclairage des places ou des massifs

► Klassieke bolderlampen met dimbare en warmwitte 24V-filamentlampen  
► Rondom schijnend voor de verlichting van paden, specifieke plekken of borders



**Plug & Shine Classic Globe**

incl. 1x2 W, E14  
160 lm, 3.000 K  
24 V  
⌄800 ⌀200 mm  
EAN 4000870 943212  
**943.21**



- 🔗 Anthrazit 🧱 Metall
- 🔗 Anthracite 🧱 Métal
- 🔗 Antraciet 🧱 Metaal





- ▶ Pollerleuchten klassisch mit dimmbaren warmweißen 24 V-Filament-Lampen
- ▶ Rundumstrahlend für die Beleuchtung von Plätzen oder Beeten

- ▶ Bornes lumineuses classiques avec ampoules à filament de 24 V gradables en blanc chaud
- ▶ Éclairage rayonnant à 360° pour l'éclairage des places ou des massifs

- ▶ Klassieke bolderlampen met dimbare en warmwitte 24V-filamentlampen
- ▶ Rondom schijnend voor de verlichting van paden, specifieke plekken of borders

**Plug & Shine Poller Classic**

incl. 1x2W, E14  
160lm, 3.000 K  
24V  
±500 ø172 mm  
EAN 4000870 943229

**943.22**

- 🔧 Anthrazit 📦 Metall
- 🔧 Anthracite 📦 Métal
- 🔧 Antraciet 📦 Metaal

IP44

roest  
vrij

- ▶ Pollerleuchten klassisch mit dimmbaren warmweißen 24 V-Filament-Lampen
- ▶ Rundumstrahlend für die Beleuchtung von Plätzen oder Beeten

- ▶ Bornes lumineuses classiques avec ampoules à filament de 24 V gradables en blanc chaud
- ▶ Éclairage rayonnant à 360° pour l'éclairage des places ou des massifs

- ▶ Klassieke bolderlampen met dimbare en warmwitte 24V-filamentlampen
- ▶ Rondom schijnend voor de verlichting van paden, specifieke plekken of borders

**Plug & Shine Mini Poller Classic**

incl. 1x2W, E14  
160lm, 3.000 K  
24V  
±220 ø80 mm  
EAN 4000870 943236

**943.23**

- 🔧 Anthrazit 📦 Metall
- 🔧 Anthracite 📦 Métal
- 🔧 Antraciet 📦 Metaal

IP44

roest  
vrij



- ▶ Dezentere Lichtstab für Beleuchtungsanwendungen an Wegen und Beeten
- ▶ Erdspieß für die flexible Installation in jedem Garten
- ▶ Lichtstab discret pour l'éclairage des allées et des massifs
- ▶ Piquet à planter pour un positionnement flexible dans le jardin
- ▶ Decente lichtstaaf voor verlichtingstoepassingen langs paden en bloemperken
- ▶ Grondpen voor die flexibele installatie in elke tuin

**Plug & Shine PIM 360**

incl. 1x5,5 W  
490 lm, 3.000 K  
24 V

⌀360 ø20 mm  
EAN 4000870 945308

**945.30 new**

🔗 Anthrazit 📦 Aluminium/Kunststoff  
🔗 Anthracite 📦 Aluminium/Matière plastique  
🔗 Antraciet 📦 Aluminium/Kunststof

☀️ IP44  
⚡



- ▶ Ideal für die Beleuchtung von Wegen, Plätzen oder Beetgrenzen
- ▶ Erdspieß für kinderleichte Fixierung in weichen Böden
- ▶ Idéal pour l'éclairage des allées, des places et des bordures de massifs
- ▶ Piquet à planter pour une fixation simplissime dans les sols meubles
- ▶ Ideaal voor de verlichting van paden, specifieke plekken of borders
- ▶ Grondpen voor zeer gemakkelijke plaatsing in zachte ondergronden

**Plug & Shine Flarea 200**

incl. 1x3,6 W  
270 lm, 3.000 K  
24 V

⌀200 ø45 mm  
EAN 4000870 945339

**945.33 new**

🔗 Schwarz 📦 Metall  
🔗 Noir 📦 Métal  
🔗 Zwart 📦 Metaal

☀️ IP65  
⚡

**Plug & Shine Flarea 400**

incl. 1x3,6 W  
270 lm, 3.000 K  
24 V

⌀400 ø45 mm  
EAN 4000870 945360

**945.36 new**

🔗 Schwarz 📦 Metall  
🔗 Noir 📦 Métal  
🔗 Zwart 📦 Metaal

☀️ IP65  
⚡

**Plug & Shine Flarea 600**

incl. 1x3,6 W  
270 lm, 3.000 K  
24 V

⌀600 ø45 mm  
EAN 4000870 945377

**945.37 new**

🔗 Schwarz 📦 Metall  
🔗 Noir 📦 Métal  
🔗 Zwart 📦 Metaal

☀️ IP65  
⚡





- ▶ Lichtobjekte für die stimmungsvolle Beleuchtung von Garten und Terrasse
- ▶ Objets lumineux pour l'éclairage agréable du jardin et de la terrasse
- ▶ Lichtobjecten voor de sfeervolle verlichting van tuin en terras
- ▶ Stufenlose Lichtfarbensteuerung per Zigbee-Fernbedienung, App oder Sprache
- ▶ Contrôle en continu de la température de couleur par télécommande Zigbee, application ou commande vocale
- ▶ Traploze lichtkleurbesturing met Zigbee-afstandsbediening, app of spraak



**Plug & Shine Cube**

incl. 1x2,8 W  
 180 lm, 3.000 - 6.500 K  
 24 V  
 ∅200 ⇄200 ↗200 mm  
 EAN 4000870 942680

**942.68**

- 🔗 Weiß 📦 Kunststoff
- 🔗 Blanc 📦 Matière plastique
- 🔗 Wit 📦 Kunststof



**Plug & Shine Globe**

incl. 1x2,8 W  
 180 lm, 3.000 - 6.500 K  
 24 V  
 ∅200 mm  
 EAN 4000870 942697

**942.69**

- 🔗 Weiß 📦 Kunststoff
- 🔗 Blanc 📦 Matière plastique
- 🔗 Wit 📦 Kunststof

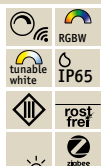

- ▶ Lichtobjekte für die stimmungsvolle Beleuchtung von Garten und Terrasse
- ▶ Objets lumineux pour l'éclairage agréable du jardin et de la terrasse
- ▶ Lichtobjecten voor de sfeervolle verlichting van tuin en terras



**Plug & Shine Globe**

incl. 1x2,8 W  
 235 lm, 3.000 K  
 24 V, ∅200 mm  
 EAN 4000870 941775

**941.77**

- 🔗 Weiß 📦 Kunststoff
- 🔗 Blanc 📦 Matière plastique
- 🔗 Wit 📦 Kunststof



**Plug & Shine Globe**

incl. 1x6,5 W  
 575 lm, 3.000 K  
 24 V, ∅400 mm  
 EAN 4000870 941782

**941.78**

- 🔗 Weiß 📦 Kunststoff
- 🔗 Blanc 📦 Matière plastique
- 🔗 Wit 📦 Kunststof



**Plug & Shine Globe**

incl. 1x6,5 W  
 575 lm, 3.000 K  
 24 V, ∅500 mm  
 EAN 4000870 941799

**941.79**

- 🔗 Weiß 📦 Kunststoff
- 🔗 Blanc 📦 Matière plastique
- 🔗 Wit 📦 Kunststof





**Plug & Shine Stone**

incl. 1×2,8 W  
235 lm, 3.000 K  
24 V  
∅166 ∅280 mm  
EAN 4000870 941751

**941.75**

- ☞ Weiß ☐ Kunststoff
- ☞ Blanc ☐ Matière plastique
- ☞ Wit ☐ Kunststof



**Plug & Shine Stone**

incl. 1×2,8 W  
235 lm, 3.000 K  
24 V  
∅194 ∅350 mm  
EAN 4000870 941768

**941.76**

- ☞ Weiß ☐ Kunststoff
- ☞ Blanc ☐ Matière plastique
- ☞ Wit ☐ Kunststof



**Plug & Shine Cube**

incl. 1×2,8 W  
235 lm, 3.000 K  
24 V  
∅200 ∅200 ∅200 mm  
EAN 4000870 941805

**941.80**

- ☞ Weiß ☐ Kunststoff
- ☞ Blanc ☐ Matière plastique
- ☞ Wit ☐ Kunststof



**Plug & Shine Cube**

incl. 1×6,5 W  
575 lm, 3.000 K  
24 V  
∅300 ∅300 ∅300 mm  
EAN 4000870 941812

**941.81**

- ☞ Weiß ☐ Kunststoff
- ☞ Blanc ☐ Matière plastique
- ☞ Wit ☐ Kunststof



**Plug & Shine Star**

incl. 1×2,6 W  
235 lm, 3.000 K  
24 V  
∅100 ∅400 mm  
EAN 4000870 941843

**941.84**

- ☞ Weiß ☐ Kunststoff
- ☞ Blanc ☐ Matière plastique
- ☞ Wit ☐ Kunststof



**Plug & Shine Tree**

incl. 1×2 W  
260 lm, 3.000 K  
24 V  
∅490 ∅280 ∅140 mm  
EAN 4000870 941850

**941.85**

- ☞ Weiß ☐ Kunststoff
- ☞ Blanc ☐ Matière plastique
- ☞ Wit ☐ Kunststof





► Lichterketten für flexible, dekorative Zusatzbeleuchtung im Garten, an Sitzplätzen oder auf der Terrasse

► Guirlandes lumineuses pour un éclairage ornemental additionnel dans le jardin, l'espace assis ou sur la terrasse

► Lichtkettingen voor flexibele aanvullende verlichting in de tuin, bij zitjes of op het terras.



#### Plug & Shine Light Chain

incl. 1,8W, 48x  
3.000 K  
24 V  
∅18 mm ⇔ 5 m  
EAN 4000870 945582  
**945.58 new**



🔗 Schwarz 📦 Kunststoff  
🔗 Noir 📦 Matière plastique  
🔗 Zwart 📦 Kunststof



#### Plug & Shine Light Chain

incl. 2W, 72x  
3.000 K  
24 V  
∅18 mm ⇔ 7,5 m  
EAN 4000870 945575  
**945.57 new**



🔗 Schwarz 📦 Kunststoff  
🔗 Noir 📦 Matière plastique  
🔗 Zwart 📦 Kunststof



#### Plug & Shine Lightchain

incl. 7x0,2W  
7x25 lm  
24 V  
∅50 mm ⇔ 6,8 m  
EAN 4000870 941652  
**941.65**



🔗 Weiß 📦 Kunststoff  
🔗 Blanc 📦 Matière plastique  
🔗 Wit 📦 Kunststof

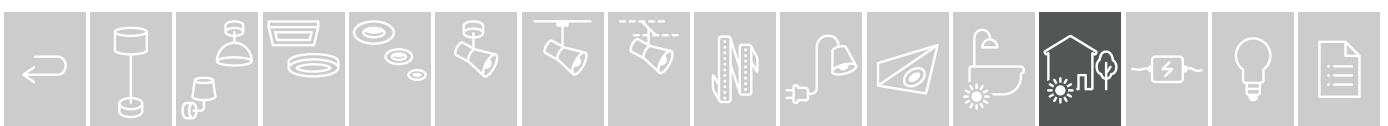



- ▶ Lichtakzente für den Garten und die Terrasse
- ▶ Indirekte Beleuchten von Terrassen, Treppen und Beetgrenzen

- ▶ Touches de lumière pour le jardin et la terrasse
- ▶ Éclairage indirect de terrasses, escaliers et bordures de parterres

- ▶ Lichtaccenten voor de tuin en het terras
- ▶ Indirecte verlichting van terrassen, trappen en borders



**Plug & Shine Smooth Strip 5m**



incl. 1x31 W  
3.050 lm, 3.000 K  
24 V  
∅14 mm ⇔9,2 mm ⇔5 m  
EAN 4000870 941911  
**941.91**

- 🎨 Weiß  Kunststoff
- 🎨 Blanc  Matière plastique
- 🎨 Wit  Kunststof



**Plug & Shine Smooth Strip Clip Set**



∅17,5 ⇔50 ⇔10,6 mm  
EAN 4000870 942154  
**942.15** 

- 🎨 Alu  Alu
- 🎨 Alu  Alu
- 🎨 Alu  Alu



**Plug & Shine Smooth Strip Alu Profil**

∅17,5 mm ⇔10,6 mm ⇔1 m  
EAN 4000870 942161  
**942.16**

- 🎨 Alu  Alu
- 🎨 Alu  Alu
- 🎨 Alu  Alu



-  RGBW
-  tunable white
-  smart controllable
-  zigbee



**Plug & Shine Smooth 2m**



incl. 1x11 W  
1.040 lm, 3.000 K  
DC 24 V  
∅20 mm ⇔10 mm ⇔2 m  
EAN 4000870 945605  
**945.60 new**

- 🎨 Weiß  Kunststoff
- 🎨 Blanc  Matière plastique
- 🎨 Wit  Kunststof



**Plug & Shine Smooth 5m**



incl. 1x22 W  
2.600 lm, 3.000 K  
DC 24 V  
∅20 mm ⇔10 mm ⇔5 m  
EAN 4000870 945612  
**945.61 new**

- 🎨 Weiß  Kunststoff
- 🎨 Blanc  Matière plastique
- 🎨 Wit  Kunststof



**Plug & Shine Smooth 10m**

incl. 1x39 W  
5.200 lm, 3.000 K  
DC 24 V  
∅20 mm ⇔10 mm ⇔10 m  
EAN 4000870 945629  
**945.62 new**

- 🎨 Weiß  Kunststoff
- 🎨 Blanc  Matière plastique
- 🎨 Wit  Kunststof

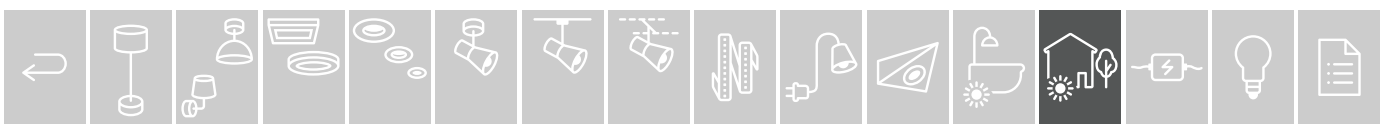



- ▶ Mehrfach gesicherte, UV-beständige Gummischlauchleitung
- ▶ Für hohe mechanische Belastung für die dauerhafte Verwendung im Freien
- ▶ Speziell entwickelte mehrfach gedichtete Paulmann-Steckverbindungen
- ▶ Dauerhaft wasserdicht (IP 68)
- ▶ Gaine en caoutchouc résistante aux UV, et plusieurs fois sécurisée.
- ▶ Pour une forte sollicitation mécanique et l'utilisation continue à l'air libre
- ▶ Connexions Paulmann spécialement conçues à multiples niveaux d'étanchéité
- ▶ Étanches durablement (IP 68)
- ▶ Extra beveiligde, UV-bestendige rubberslangleiding
- ▶ Voor hoge mechanische belasting voor duurzaam gebruik buitenshuis
- ▶ Speciaal ontwikkelde maximaal geïsoleerde Paulmann-steekverbindingen
- ▶ Duurzaam waterdicht (IP 68)



🎧 Schwarz 🧱 Kunststoff  
 🎧 Noir 🧱 Matière plastique  
 🎧 Zwart 🧱 Kunststof

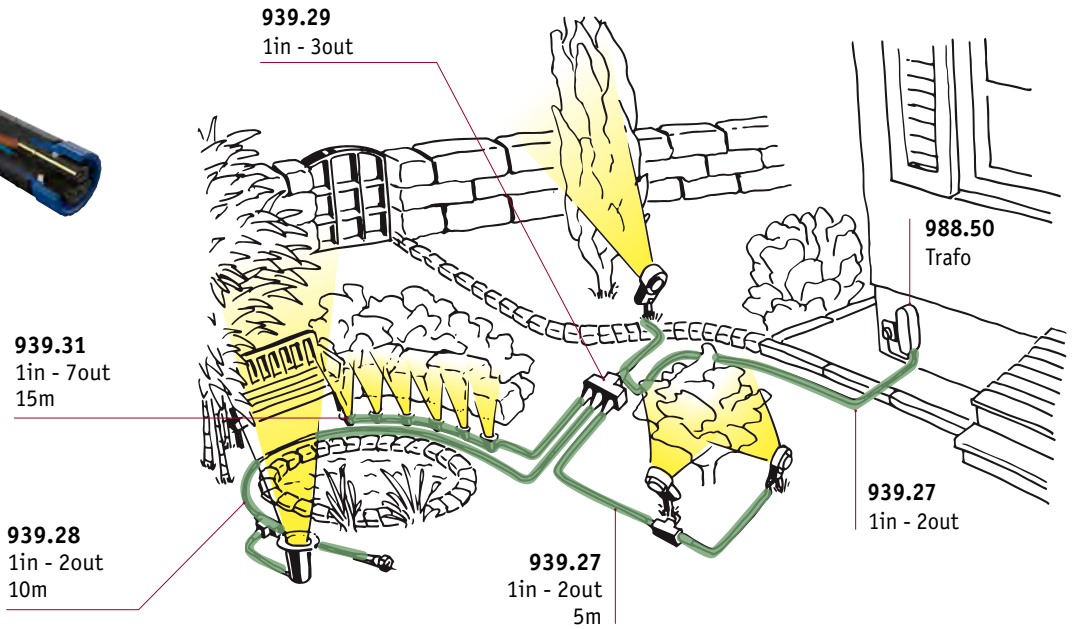

**Plug & Shine Connector 1in-3out**

max. 150 W  
 24 V  
 ⚡ 75 ⇔ 94 mm  
 EAN 4000870 939291  
**939.29**



**Plug & Shine Cable 1in-3out**

max. 150 W  
 24 V  
 ⚡ 1 m  
 EAN 4000870 939949  
**939.94**



**Plug & Shine Cable 1in-2out**

max. 150 W  
 24 V  
 ⚡ 2 m  
 EAN 4000870 939260  
**939.26**



**Plug & Shine Cable 1in-2out**

max. 150 W  
 24 V  
 ⚡ 5 m  
 EAN 4000870 939277  
**939.27**







**Plug & Shine Cable 1in-2out**

max. 150 W  
24 V  
↔10 m  
EAN 4000870 939284  
**939.28**



**Plug & Shine Cable 1in-5out**

max. 150 W  
24 V  
↔10 m  
EAN 4000870 939307  
**939.30**



**Plug & Shine Cable 1in-7out**

max. 150 W  
24 V  
↔15 m  
EAN 4000870 939314  
**939.31**



**Plug & Shine Twilight Sensor**

3xAA/1,5 V (Mignon)  
4,8 V  
↕120 ↔65 ↗40 mm  
EAN 4000870 180129

**180.12**

⌘ Schwarz ▣ Kunststoff  
⌘ Noir ▣ Matière plastique  
⌘ Zwart ▣ Kunststof



- ▶ Zigbee 3.0 Schalt- und Dimm-Controller für das 24V DC Gartenleuchten-System Plug & Shine
- ▶ Einfache und sichere Installation mit Plug & Shine Verbinder
- ▶ Für alle dimmbaren Plug & Shine Leuchten geeignet
- ▶ Gruppenschaltung oder Schaltung mehrerer Controller mit einer Fernbedienung möglich

- ▶ Contrôleur commutation et variation Zigbee 3.0 pour système de luminaires de jardin Plug & Shine 24V DC
- ▶ Installation sûre et simple grâce au connecteur Plug & Shine
- ▶ Convient à tous les luminaires Plug & Shine grad
- ▶ La commutation groupée ou la commutation de plusieurs controllers est possible avec une seule télécommande.

- ▶ Zigbee 3.0 schakel- en dimcontroller voor het 24V DC tuinverlichtingssysteem Plug & Shine
- ▶ Eenvoudige en veilige installatie met Plug & Shine connector
- ▶ Geschikt voor alle dimbare Plug & Shine armaturen
- ▶ Groepsschakeling of schakeling van meerdere controllers mogelijk met één afstandsbediening



**Plug & Shine Zigbee Controller**

max. 75 W  
24 V  
↕30 ↔260 ↗40 mm  
EAN 4000870 939994  
**939.99**

⌘ Schwarz ▣ Kunststoff  
⌘ Noir ▣ Matière plastique  
⌘ Zwart ▣ Kunststof



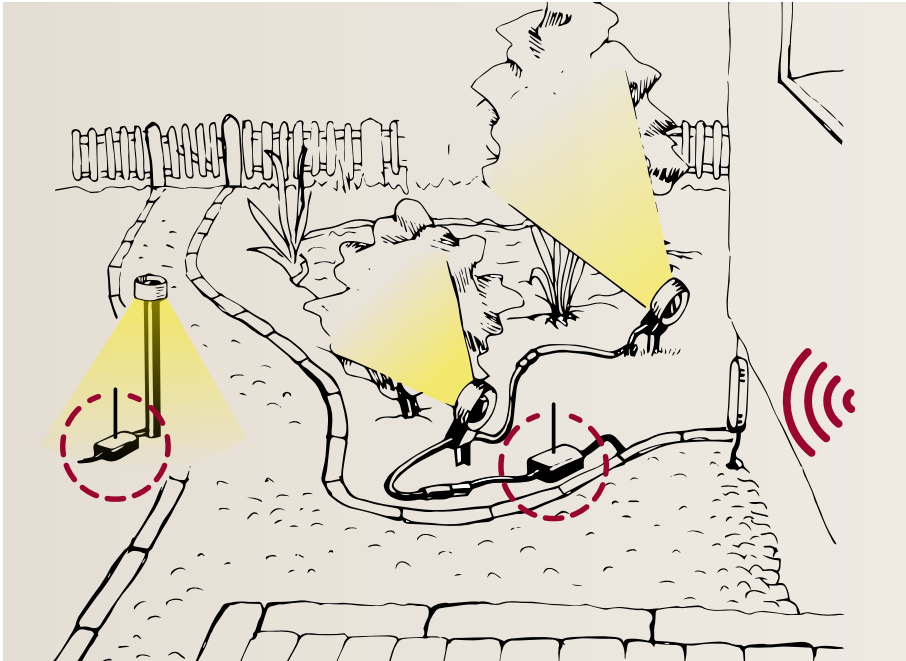

► Gruppenschaltung oder Schaltung mehrerer Controller mit einer Fernbedienung möglich

► La commutation groupée ou la commutation de plusieurs controllers est possible avec une seule télécommande.

► Groepsschakeling of schakeling van meerdere controllers mogelijk met één afstandsbediening



**Plug & Shine Controller incl. remote**

max. 75 W  
2xAAA/1,5V (Micro)  
24 V  
∅90 ⇔260 ↗40 mm  
EAN 4000870 180112

**180.11**

- ↳ Schwarz ▣ Kunststoff
- ↳ Noir ▣ Matière plastique
- ↳ Zwart ▣ Kunststof



**Plug & Shine Controller**

max. 75 W  
24 V  
∅90 ⇔260 ↗40 mm  
EAN 4000870 180105

**180.10**

- ↳ Schwarz ▣ Kunststoff
- ↳ Noir ▣ Matière plastique
- ↳ Zwart ▣ Kunststof

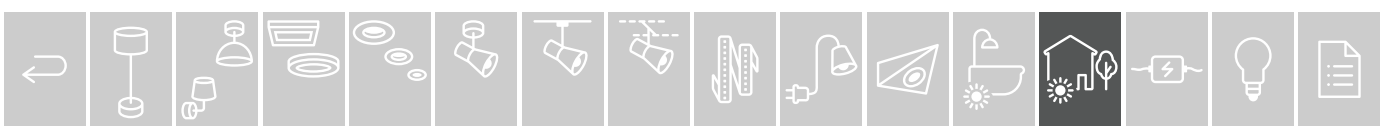



► Steckerdriver IP44 ideal für die Beleuchtung von Balkon und des Terrassenbereichs

► Driver de fiche IP44 idéal pour l'éclairage des balcons et terrasses

► Stekkerdriver IP44 ideaal voor de verlichting van balkon en terras



**Power Supply 21W IP44**  
230/24V DC

max. 21W  
230/24 V, incl. ⚡ 21 VA  
⌀103 ⇄50 ⌀30 mm  
EAN 4000870 988480  
**988.48**



**Power Supply 75W IP44**  
230/24V DC

max. 75W  
230/24 V, incl. ⚡ 75 VA  
⌀36 ⇄68 ⌀199 mm  
EAN 4000870 988497  
**988.49**

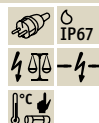

**Power Supply 150W IP44**  
230/24V DC

max. 150W  
230/24 V, incl. ⚡ 150 VA  
⌀40 ⇄70 ⌀191 mm  
EAN 4000870 988503  
**988.50**

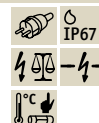

► Formschöne Trafo-Montage-Box für eine stimmige Integration eines Trafos an der Hauswand

► Élégant boîtier de pose de transformateur pour intégrer celui-ci de façon harmonieuse contre le mur.

► Trafomontagebox met mooie vorm voor een passende integratie van een trafo aan de huiswand

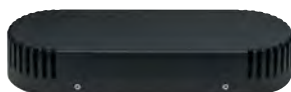

**Trafo-Box**

⌀45 ⇄260 ⌀89 mm  
EAN 4000870 939048  
**939.04**

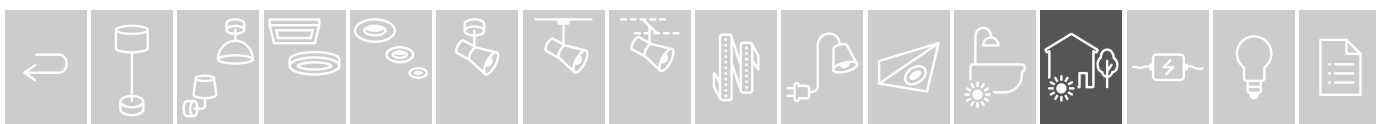



## Park + Light: Das innovative 12V Lichtsystem für Carports

Das Park + Light Lichtsystem ermöglicht individuell konfigurierbare Beleuchtungslösungen für die Dächer und Wände von Carports, Garagen oder auch Gartenhäusern und Terrassendächern mit nur einer Stromquelle.

Die lichtstarken Wand- und Deckenleuchten sorgen für Sicherheit und Orientierung beim Beladen oder Pflegen des Fahrzeugs, bei Reparatur- oder Räumarbeiten oder auf dem Weg zum Haus.

Das kompakte 12V Lichtsystem ist kinderleicht zu installieren und sicher. Mit IP67 besteht bestmöglicher Schutz gegen das Eindringen von Wasser. Es lässt sich flexibel zusammenstellen, erweitern und jederzeit wieder verändern.

Die Park + Light Leuchten lassen sich direkt miteinander oder mit T-Verbinder zusammenschließen, erweitern oder auch um- oder zurückbauen.

Die Strom-Einspeisung erfolgt mittels Steckertrafo (945.79, 945.80), per Adapter aus dem Plug & Shine-System (945.50) oder auch mittels Solar-Panel (945.51, 945.52).

Mit dem passenden Zigbee-Adapter (945.55) lässt sich das Licht smart per Fernbedienung, Sprache oder App steuern.

## Park + Light : Le système d'éclairage 12 V innovant pour les carports

Le système d'éclairage Park + Light offre des solutions d'éclairage configurables individuellement pour les toits et les murs des carports, des garages, des abris de jardin ou même des toits de terrasse avec une seule source d'alimentation électrique.

Ces appliques et plafonniers puissants assurent la sécurité et l'orientation des personnes lors du chargement ou de l'entretien du véhicule, pendant les travaux de réparation ou de déblaiement ou sur le chemin de la maison.

Ce système d'éclairage compact de 12 V est très facile à installer en toute sécurité. La protection IP67 correspond à la protection la plus efficace contre l'infiltration d'eau.

Le système peut être assemblé, complété et modifié à tout moment et en toute flexibilité. Les luminaires Park + Light peuvent être reliés directement entre eux ou avec des connecteurs en T, étendus et même transformés ou décomposés.

L'alimentation électrique s'effectue au moyen d'un transfo prise (945.79, 945.80), d'un adaptateur du système Plug & Shine (945.50) ou par panneau solaire (945.51, 945.52).

Avec l'adaptateur Zigbee compatible (945.55), l'éclairage peut être commandé intelligemment par télécommande, voix ou appli.

## Park + Light: Het innovatieve 12V-lichtsysteem voor carports

Het Park + Light lightsysteem maakt individueel configureerbare verlichtingsoplossingen met slechts één stroombron voor de daken en wanden van carports, garages of schuren en voor terrasdaken mogelijk.

De lichtsterke wand- en plafondlampen zorgen voor veiligheid en oriëntatie tijdens het inladen of onderhouden van de auto, bij reparaties of opruimwerkzaamheden of op weg naar het huis.

Het compacte 12V-lichtsysteem is heel eenvoudig te installeren en veilig. Met IP67 worden deze optimaal beschermd tegen het binnendringen van water. Hij kan flexibel samengesteld, uitgebreid en altijd weer veranderd worden.

De Park + Light armaturen kunnen rechtstreeks met elkaar of met een T-verbinding aan elkaar worden gekoppeld of uitgebreid, maar ook worden veranderd of gedemonteerd.

De voeding verloopt via stekkertrafo (945.79, 945.80), via adapter uit het Plug & Shine systeem (945.50), maar ook via zonnepaneel (945.51, 945.52).

Met de bijpassende Zigbee-adaptor (945.55) kan het licht smart worden bestuurd via afstandsbediening, spraak of app.

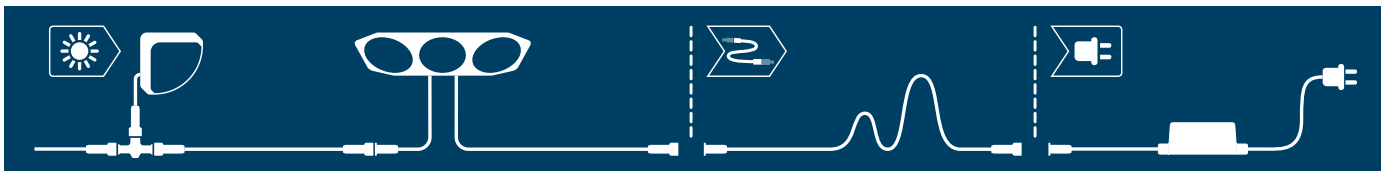



- ▶ Beleuchtung mit Montagemöglichkeit an Wand und Decke
- ▶ Lichtausrichtung durch 90° Schwenkbarkeit einstellbar

- ▶ Éclairage avec possibilité de montage au mur et au plafond
- ▶ Orientation réglable de la lumière grâce au pivotement à 90°

- ▶ Verlichting met montagemogelijkheden aan wand en plafond
- ▶ Richting van het licht instelbaar door 90° zwenkbaarheid

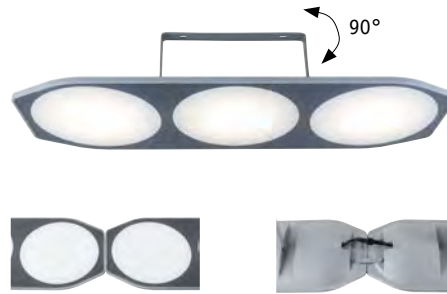
**Park + Light Route**

incl. 3×2 W  
3×180 lm, 3.000 K  
12 V  
⇅173 ⇄50 ↗111 mm  
EAN 4000870 945100

**945.10 new**

- ↳ Anthrazit 田 Kunststoff
- ↳ Anthracite 田 Matière plastique
- ↳ Antraciet 田 Kunststof



90°  
4-8m  
On < 20Lux / Off > 20Lux  
Time ON 30 sec.

**Park + Light Ikosea**

incl. 2×2,8 W  
2×300 lm, 3.000 K  
12 V  
⇅185 ⇄50 ↗203 mm  
EAN 4000870 945186

**945.18 new**

- ↳ Anthrazit 田 Kunststoff
- ↳ Anthracite 田 Matière plastique
- ↳ Antraciet 田 Kunststof



120°  
3m  
20Lux  
Time ON 30 sec.

**Park + Light Bimea**

incl. 1×4,5 W  
430 lm, 3.000 K  
12 V  
⇅103 ⇄103 ↗23 mm  
EAN 4000870 945858

**945.85 new**

- ↳ Anthrazit 田 Kunststoff
- ↳ Anthracite 田 Matière plastique
- ↳ Antraciet 田 Kunststof

**Park + Light Bimea motion detect**

incl. 1×4,5 W  
430 lm, 3.000 K  
12 V  
⇅125 ⇄103 ↗23 mm  
EAN 4000870 945865

**945.86 new**

- ↳ Anthrazit 田 Kunststoff
- ↳ Anthracite 田 Matière plastique
- ↳ Antraciet 田 Kunststof





**Park + Light Cable 1m**

max. 24 W  
↔ 1 m  
EAN 4000870 945810  
**945.81 new**



- ↳ Schwarz ▣ Kunststoff
- ↳ Noir ▣ Matière plastique
- ↳ Zwart ▣ Kunststof



**Park + Light Cable 2m**

max. 24 W  
↔ 2 m  
EAN 4000870 945827  
**945.82 new**



- ↳ Schwarz ▣ Kunststoff
- ↳ Noir ▣ Matière plastique
- ↳ Zwart ▣ Kunststof



**Park + Light Cable 3m**

max. 24 W  
↔ 3 m  
EAN 4000870 945834  
**945.83 new**



- ↳ Schwarz ▣ Kunststoff
- ↳ Noir ▣ Matière plastique
- ↳ Zwart ▣ Kunststof



**Park + Light Connector**

max. 24 W  
↔ 53 ↔ 38 mm  
EAN 4000870 945841  
**945.84 new**



- ↳ Schwarz ▣ Kunststoff
- ↳ Noir ▣ Matière plastique
- ↳ Zwart ▣ Kunststof

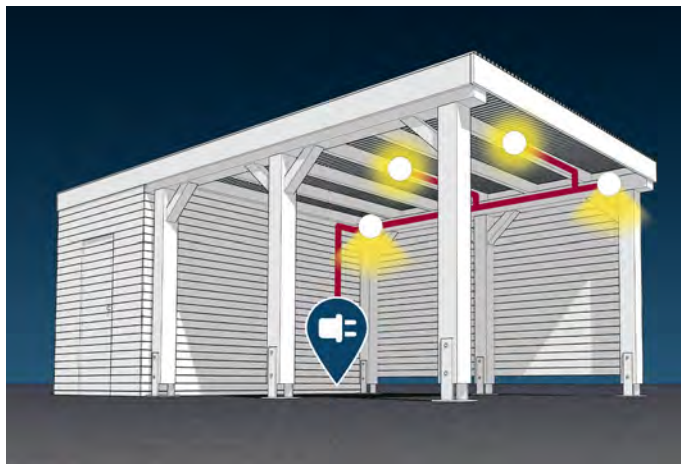

**Park + Light Power Supply**

incl. ↳ 14 VA  
↕ 47 ↔ 30 ↗ 124 mm  
EAN 4000870 945797  
**945.79 new**



- ↳ Schwarz ▣ Kunststoff
- ↳ Noir ▣ Matière plastique
- ↳ Zwart ▣ Kunststof



**Park + Light Power Supply**

incl. ↳ 24 VA  
↕ 43 ↔ 51 ↗ 180 mm  
EAN 4000870 945803  
**945.80 new**



- ↳ Schwarz ▣ Kunststoff
- ↳ Noir ▣ Matière plastique
- ↳ Zwart ▣ Kunststof

▶ Solarzelle mit Batterie für die Versorgung des Park + Light Systems ohne Stromanschluss

▶ Cellule solaire avec pile pour l'alimentation du système Park + Light sans prise

▶ Zonnecel met batterij om het Park + Light systeem zonder netaansluiting te voeden



**Park + Light Solar Charger**

max. 5 W  
3x18650 Akku/3,7V  
12 V  
↕ 235 ↔ 350 ↗ 69 mm  
EAN 4000870 945513  
**945.51 new**



- ↳ Silber
- ↳ Argent
- ↳ Zilver



**Park + Light Solar Charger**

max. 10 W  
3x18650 Akku/3,7V  
12 V  
↕ 235 ↔ 350 ↗ 69 mm  
EAN 4000870 945520  
**945.52 new**



- ↳ Silber
- ↳ Argent
- ↳ Zilver





- ▶ Park + Light Adapter: Einfach an bestehendes Plug & Shine Lichtsystem anbinden
- ▶ Kein weiterer Trafo erforderlich

- ▶ Adaptateur Park + Light : facile à connecter au système d'éclairage Plug & Shine existant
- ▶ Aucun autre transfo nécessaire

- ▶ Park + Light adapter: eenvoudig koppelbaar aan bestaand Plug & Shine lichtstelsel
- ▶ Geen extra trafo nodig



**Adapter Plug & Shine > Park+Light**

max. 24 W  
 24 V, incl. ⚡ 24 VA  
 ⌀30 ⇄40,5 ⤴80 mm  
 EAN 4000870 945506  
**945.50 new**

- 🔗 Schwarz 🗪 Kunststoff
- 🔗 Noir 🗪 Matière plastique
- 🔗 Zwart 🗪 Kunststof



**Park + Light Smart Home Controller Zigbee**

max. 24 W  
 12 V  
 ⌀40 ⇄90 ⤴30 mm  
 EAN 4000870 945551  
**945.55 new**

- 🔗 Schwarz 🗪 Kunststoff
- 🔗 Noir 🗪 Matière plastique
- 🔗 Zwart 🗪 Kunststof



- 🔄 dimmable
- 📶 smart controllabile
- 📶 zigbee



**Park + Light Sensor Motion Detect**

max. 24 W  
 12 V  
 ⌀40 ⇄80 ⤴57 mm  
 EAN 4000870 945568  
**945.56 new**

- 🔗 Schwarz 🗪 Kunststoff
- 🔗 Noir 🗪 Matière plastique
- 🔗 Zwart 🗪 Kunststof



- 📶 Sensor
- 120°
- 5m
- 20Lux
- Time ON 30 sec.



# House

House 230V - Die zuverlässigen 230 V  
Leuchten für Licht rund ums Haus

House 230V - Les luminaires 230 V fiables  
pour un éclairage tout autour de la maison

House 230V - De betrouwbare 230 V -  
armaturen voor licht rondom het huis

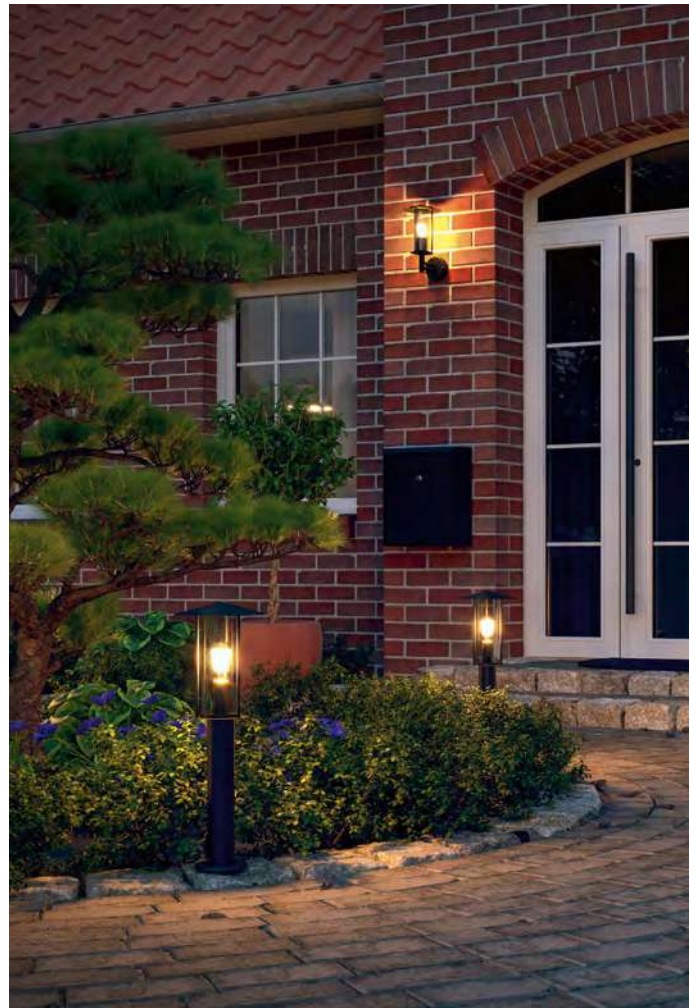

► Durch direkten Wandaufbau präzise,  
scharfe Lichteffekte

► Effets lumineux précis et nets grâce à un  
montage mural direct

► Door een directe wandopbouw zijn  
exacte, scherpe lichteffecten mogelijk

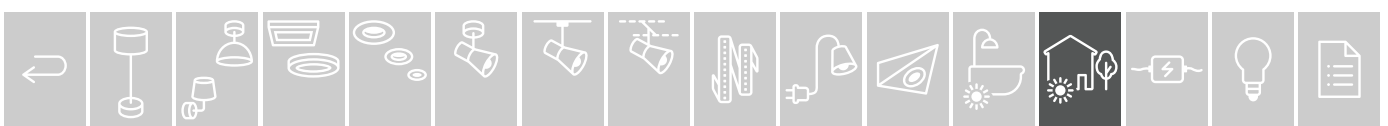

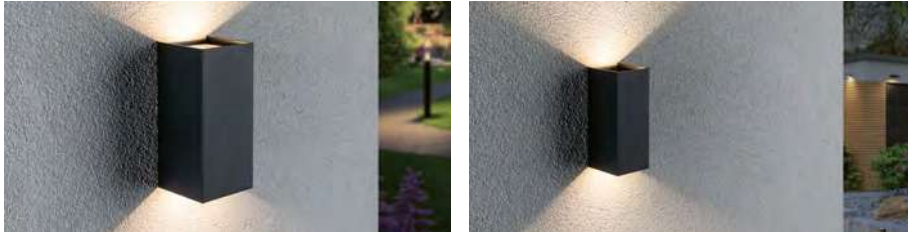

**Flame**

incl. 2×5,6 W  
2×710 lm, 3.000 K  
∠ 105°, 230 V  
∅220 ⇔102 ∇100 mm  
EAN 4000870 943250

**943.25**

- 🔗 Anthrazit 📦 Aluminium
- 🔗 Anthracite 📦 Aluminium
- 🔗 Antraciet 📦 Aluminium

**Flame**

incl. 2×2,7 W  
2×390 lm, 3.000 K  
∠ 105°, 230 V  
∅155 ⇔65 ∇70 mm  
EAN 4000870 943267

**943.26**

- 🔗 Anthrazit 📦 Aluminium
- 🔗 Anthracite 📦 Aluminium
- 🔗 Antraciet 📦 Aluminium

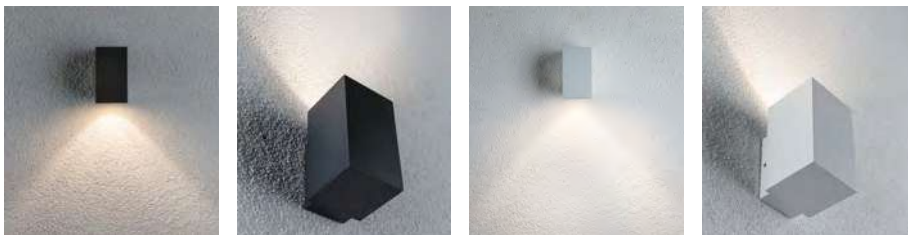
**Flame**

incl. 1×3,8 W  
450 lm, 3.000 K  
∠ 75°, 230 V  
∅103 ⇔58 ∇75 mm  
EAN 4000870 943274

**943.27**

- 🔗 Anthrazit 📦 Aluminium
- 🔗 Anthracite 📦 Aluminium
- 🔗 Antraciet 📦 Aluminium

**Flame**

incl. 1×3,8 W  
450 lm, 3.000 K  
∠ 75°, 230 V  
∅103 ⇔58 ∇75 mm  
EAN 4000870 943298

**943.29**

- 🔗 Weiß 📦 Alu
- 🔗 Blanc 📦 Alu
- 🔗 Wit 📦 Alu

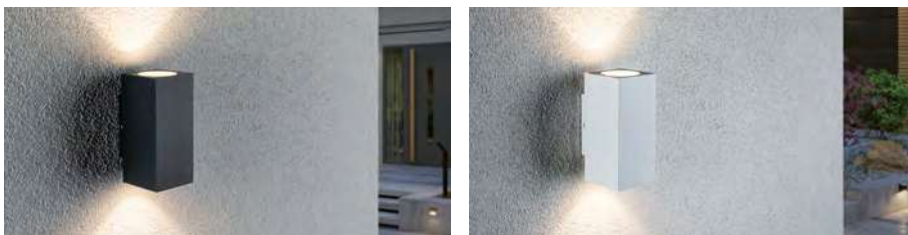
**Flame**

incl. 2×2,7 W  
2×390 lm, 3.000 K  
∠ 75°, 230 V  
∅128 ⇔58 ∇75 mm  
EAN 4000870 943281

**943.28**

- 🔗 Anthrazit 📦 Aluminium
- 🔗 Anthracite 📦 Aluminium
- 🔗 Antraciet 📦 Aluminium

**Flame**

incl. 2×2,7 W  
2×390 lm, 3.000 K  
∠ 75°, 230 V  
∅128 ⇔58 ∇75 mm  
EAN 4000870 943304

**943.30**

- 🔗 Weiß 📦 Alu
- 🔗 Blanc 📦 Alu
- 🔗 Wit 📦 Alu





- ▶ Die Wandleuchten-Serie Flame für attraktive Lichteffekte
- ▶ Für GU10 Leuchtmittel

- ▶ La gamme d'appliques Flame pour des effets lumineux attrayants
- ▶ Pour les ampoules GU10

- ▶ De wandlampenserie Flame voor aantrekkelijke lichteffecten
- ▶ Voor GU10-verlichtingsmiddelen



**Flame**

max. 2×10 W, GU10  
230 V  
↑163 ∅60 ↔73 ↗110 mm  
EAN 4000870 943311

**943.31**

↳ Edelmetall gebürstet ▣ Edelmetall/  
Kunststoff  
↳ Acier inoxydable brossé  
▣ Acier inoxydable/Matière plastique  
↳ Geborsteld roestvrij staal ▣ edelstaal/  
Kunststof



↘ 40-120°



- ▶ Ausstrahlwinkel 40-120° variabel einstellbar durch Klappmechanismus

- ▶ Angle de rayonnement variable de 40 à 120° réglable par un mécanisme de pliage

- ▶ Uitstralhoek 40-120° variabel instelbaar door klappmechanisme



**Cybo**

incl. 2×3 W  
2×355 lm, 2.700 K  
↘ 40°-120°  
230 V  
↑80 ↔80 ↗80 mm  
EAN 4000870 180006

**180.00**

↳ Grau ▣ Alu  
↳ Gris ▣ Alu  
↳ Grijs ▣ Alu



**Cybo**

incl. 2×3 W  
2×355 lm, 2.700 K  
↘ 40°-120°  
230 V  
↑80 ↔80 ↗80 mm  
EAN 4000870 180013

**180.01**

↳ Weiß ▣ Alu  
↳ Blanc ▣ Alu  
↳ Wit ▣ Alu





- ▶ Ausstrahlwinkel 85°
- ▶ Licht 355° drehbar

- ▶ Angle de rayonnement de 85°
- ▶ Éclairage orientable sur 355°

- ▶ Uitstraalhoek 85°
- ▶ Licht 355° draaibaar

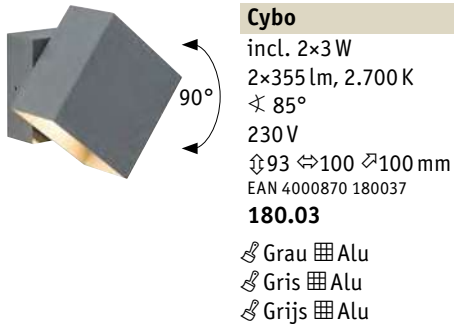
**Cybo**

incl. 2x3 W  
2x355 lm, 2.700 K  
∠ 85°  
230 V  
↑93 ↔100 ↗100 mm  
EAN 4000870 180037

**180.03**

- ↳ Grau ▣ Alu
- ↳ Gris ▣ Alu
- ↳ Grijs ▣ Alu

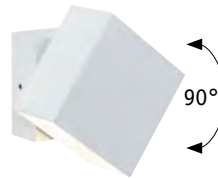
**Cybo**

incl. 2x3 W  
2x355 lm, 2.700 K  
∠ 85°  
230 V  
↑93 ↔100 ↗100 mm  
EAN 4000870 180020

**180.02**

- ↳ Weiß ▣ Alu
- ↳ Blanc ▣ Alu
- ↳ Wit ▣ Alu



90°  
2-8m  
On < 20Lux / Off > 20Lux  
Time ON < 5 sec - 5 min.



- ▶ Attraktive Wandleuchten für Hauswand und Zuwegung wahlweise mit Bewegungsmelder

- ▶ Appliques attrayantes pour le mur de la maison et l'allée avec détecteur de mouvement en option

- ▶ Aantrekkelijke wandlampen voor huismuur en toegangswegen, naar keuze met bewegingsmelder

**Capea**

incl. 1x6 W  
600 lm, 3.000 K  
∠ 98°  
230 V  
↑56 ↔96 ↗128 mm  
EAN 4000870 944523

**944.52 new**

- ↳ Grau ▣ Aluminium
- ↳ Gris ▣ Aluminium
- ↳ Grijs ▣ Aluminium

**Capea**

incl. 1x6 W  
600 lm, 3.000 K  
∠ 98°  
230 V  
↑165 ↔96 ↗153 mm  
EAN 4000870 944530

**944.53 new**

- ↳ Grau ▣ Aluminium
- ↳ Gris ▣ Aluminium
- ↳ Grijs ▣ Aluminium

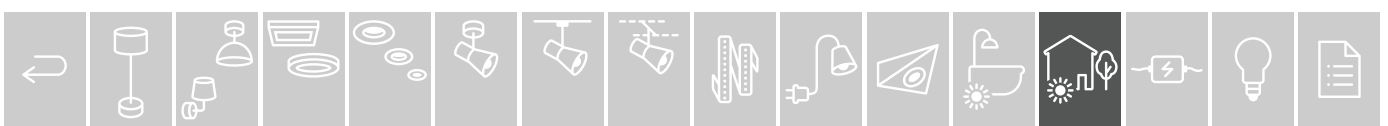

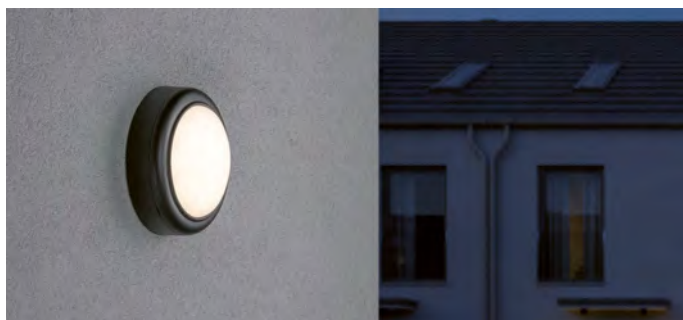
**Wall Luminaire**

incl. 1×7,6W  
800 lm, 3.000 K  
230V  
±58 ø140 mm  
EAN 4000870 941195

**941.19**

- 🔗 Grau 📦 Kunststoff
- 🔗 Gris 📦 Matière plastique
- 🔗 Grijs 📦 Kunststof

**Wall Luminaire**

incl. 1×15,2W  
1.500 lm, 3.000 K  
230V  
±66 ø180 mm  
EAN 4000870 941881

**941.88**

- 🔗 Grau 📦 Kunststoff
- 🔗 Gris 📦 Matière plastique
- 🔗 Grijs 📦 Kunststof

**Wall Luminaire**

incl. 1×13,8W  
1.500 lm, 3.000 K  
230V  
±66 ø180 mm  
EAN 4000870 941874

**941.87**

- 🔗 Grau 📦 Kunststoff
- 🔗 Gris 📦 Matière plastique
- 🔗 Grijs 📦 Kunststof



90°  
4-7m  
On < 20Lux  
Off > 20Lux  
Time ON < 30sec

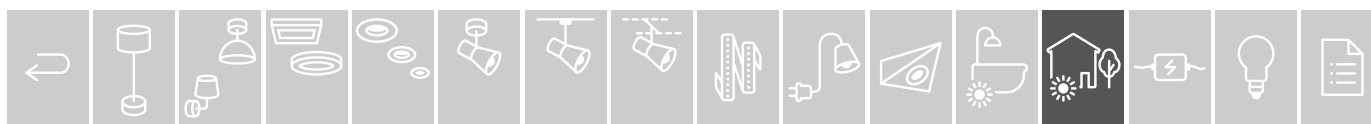



- ▶ Nostalgische Optik durch anthrazitfarbenes Gerüst und klaren Glasschirm
- ▶ Ideal für Vollglas-Filament-Lampen im Retro-Look

- ▶ Armature anthracite et abat-jour en verre clair pour un effet nostalgique
- ▶ Idéal pour les lampes à incandescence tout en verre au look rétro

- ▶ Nostalgische look door antracietgrijze behuizing en helder glazen scherm.
- ▶ Ideaal voor glazen filamentlampen in retro-look



#### Wall Luminaire

max. 60 W, E27  
230 V  
∅365 ∅160 ∇172 mm  
EAN 4000870 942826  
**942.82**

- ∅ Grau █ Glas
- ∅ Gris █ Verre
- ∅ Grijs █ Glas



#### Wall Luminaire

max. 60 W, E27  
230 V  
∅540 ∅160 ∇172 mm  
EAN 4000870 942819  
**942.81**

- ∅ Grau █ Glas
- ∅ Gris █ Verre
- ∅ Grijs █ Glas



#### Wall Classic

max. 15 W, E27  
230 V  
∅315 ∅173 ∇210 mm  
EAN 4000870 943984  
**943.98**

- ∅ Dunkelgrau █ Metall/Glas
- ∅ Gris foncé █ Métal/Verre
- ∅ Donkergrijs █ Metaal/Glas



#### Wall Classic

max. 15 W, E27  
230 V  
∅327 ∅173 ∇210 mm  
EAN 4000870 943960  
**943.96**

- ∅ Dunkelgrau █ Metall/Glas
- ∅ Gris foncé █ Métal/Verre
- ∅ Donkergrijs █ Metaal/Glas



90°  
4-8m  
On < 20Lux / Off > 20Lux  
Time ON < 5 sec - 5 min.

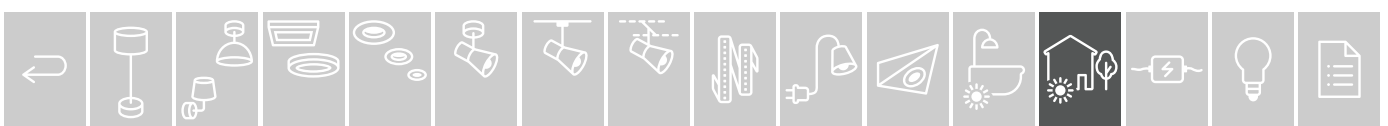





- ▶ Gerichtetes Licht für draußen mit einem Ausstrahlwinkel von 34°
- ▶ Ideal für die Beleuchtung von Hauseingängen, Vordächern, Dachüberständen, Garagen und Carports
- ▶ Lumière dirigée pour l'extérieur avec un angle de rayonnement de 34°
- ▶ Idéal pour éclairer les entrées, les auvents, les débords de toits, les garages et les carports
- ▶ Gericht licht voor buiten met een uitstraalhoek van 34°
- ▶ Ideaal voor de verlichting van entrees, afdaken, overkappingen, garages en carports



#### House Downlight

incl. 1x5,8W  
530 lm, 3.000 K  
✕ 34°  
230V  
⇅3 ø95 mm  
EAN 4000870 796665  
**796.66**

🌀 Silber 🗪 Metall/Acryl  
🌀 Argent 🗪 Métal/Acryl  
🌀 Zilver 🗪 Metaal/Acryl



#### House surface mounted Downlight

incl. 1x5,8W  
530 lm, 3.000 K  
✕ 34°  
230V  
⇅95 ø95 mm  
EAN 4000870 796702  
**796.70**

🌀 Anthrazit 🗪 Alu/Acryl  
🌀 Anthracite 🗪 Alu/Acryl  
🌀 Antraciet 🗪 Alu/Acryl



- ▶ Wandinbauleuchten für Orientierungsbeleuchtung rund ums Haus
- ▶ Inkl. Einbaudose für sicheren Einbau und Entnahmemöglichkeit bei späterer Wartung
- ▶ Encastrés muraux pour un éclairage d'orientation autour de la maison
- ▶ Embase encastrée incluse pour une pose sécurisée et un démontage ultérieur éventuel en vue de l'entretien
- ▶ Wandinbouwlampen voor oriëntatieverlichting rondom het huis
- ▶ Incl. inbouwdoos voor een veilige inbouw en demontage bij later onderhoud



#### Wall DL high

incl. 1x4 W  
500 lm, 3.000 K  
230V  
⇅62 ⇄103 ↗58 mm  
EAN 4000870 943823  
**943.82**

🌀 Schwarz 🗪 Aluminium  
🌀 Noir 🗪 Aluminium  
🌀 Zwart 🗪 Aluminium



#### Wall DL long

incl. 1x4 W  
500 lm, 3.000 K  
230V  
⇅62 ⇄103 ↗58 mm  
EAN 4000870 943830  
**943.83**

🌀 Schwarz 🗪 Aluminium  
🌀 Noir 🗪 Aluminium  
🌀 Zwart 🗪 Aluminium

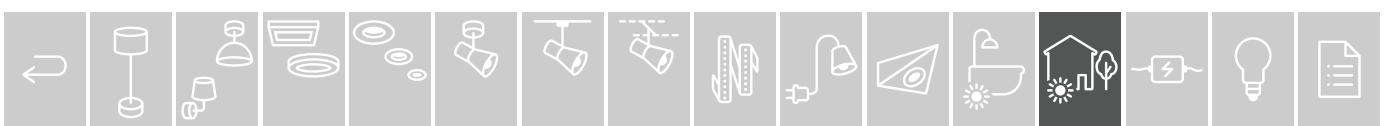
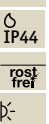

- ▶ 230 V Bodeneinbauleuchten mit dekorativen Lichteffekten
- ▶ Mit 500 kg belastbar
- ▶ Inkl. Einbaudose für sicheren Einbau und Entnahmemöglichkeit bei späterer Wartung

- ▶ Encastrés de sol 230 V avec effets lumineux décoratifs
- ▶ Charge supportée : 500 kg
- ▶ Embase encastrée incluse pour une pose sécurisée et un démontage ultérieur éventuel en vue de l'entretien

- ▶ 230V grondinbouwlampen met decoratieve lichteffecten
- ▶ Belastbaar tot 500 kg
- ▶ Incl. inbouwdoos voor een veilige inbouw en demontage bij later onderhoud



**Floor**  
 incl. 1x2 W  
 210 lm, 3.000 K  
 <math>\sphericalangle</math> 120°, 230 V  
 <math>\updownarrow</math>82 <math>\varnothing</math>50 mm  
 EAN 4000870 943632  
**943.63**  
 & Edelmetall gebürstet  
 & Edelmetall/Kunststoff  
 & Acier inoxydable brossé  
 & Acier inoxydable/  
 Matière plastique  
 & Geborsteld roestvrij staal  
 & edelstaal/Kunststof



**Floor**  
 incl. 1x2 W  
 210 lm, 3.000 K  
 <math>\sphericalangle</math> 120°, 230 V  
 <math>\updownarrow</math>82 <math>\varnothing</math>50 mm  
 EAN 4000870 943656  
**943.65**  
 & Edelmetall gebürstet  
 & Edelmetall/Kunststoff  
 & Acier inoxydable brossé  
 & Acier inoxydable/  
 Matière plastique  
 & Geborsteld roestvrij staal  
 & edelstaal/Kunststof

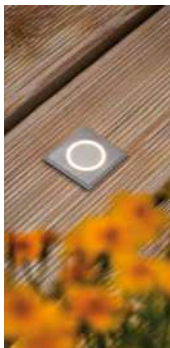

**Floor**  
 incl. 1x2 W  
 210 lm, 3.000 K  
 <math>\sphericalangle</math> 120°, 230 V  
 <math>\updownarrow</math>82 <math>\leftrightarrow</math>50 <math>\varnothing</math>50 mm  
 EAN 4000870 943649  
**943.64**  
 & Edelmetall gebürstet  
 & Edelmetall/Kunststoff  
 & Acier inoxydable brossé  
 & Acier inoxydable/  
 Matière plastique  
 & Geborsteld roestvrij staal  
 & edelstaal/Kunststof



**Floor**  
 incl. 1x2 W  
 210 lm, 3.000 K  
 <math>\sphericalangle</math> 120°, 230 V  
 <math>\updownarrow</math>82 <math>\leftrightarrow</math>50 <math>\varnothing</math>50 mm  
 EAN 4000870 943663  
**943.66**  
 & Edelmetall gebürstet  
 & Edelmetall/Kunststoff  
 & Acier inoxydable brossé  
 & Acier inoxydable/  
 Matière plastique  
 & Geborsteld roestvrij staal  
 & edelstaal/Kunststof



- ▶ Staubdicht und wasserdicht bei zeitweiligem Untertauchen (IP67)
- ▶ Betrieb direkt mit 230 V

- ▶ Protection contre la poussière et l'immersion temporaire (IP67)
- ▶ Fonctionnement direct avec 230 V

- ▶ Stofdicht en waterdicht bij tijdelijke onderdompeling (IP67)
- ▶ Rechtstreeks bedrijf met 230 V



**Floor LED**  
 incl. 1x3,5 W, GU10  
 230 lm, 3.000 K  
 230 V  
 <math>\updownarrow</math>124 <math>\varnothing</math>108 mm  
 EAN 4000870 939925  
**939.92**  
 & Edelmetall & Metall  
 & Acier inoxydable & Métal  
 & Edelstaal & Metaal



**Floor LED**  
 incl. 1x3,5 W, GU10  
 230 lm, 3.000 K  
 230 V  
 <math>\updownarrow</math>124 <math>\leftrightarrow</math>108 <math>\varnothing</math>108 mm  
 EAN 4000870 939932  
**939.93**  
 & Edelmetall & Metall  
 & Acier inoxydable & Métal  
 & Edelstaal & Metaal





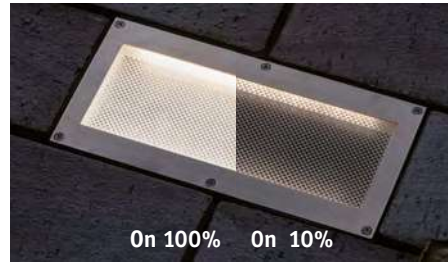
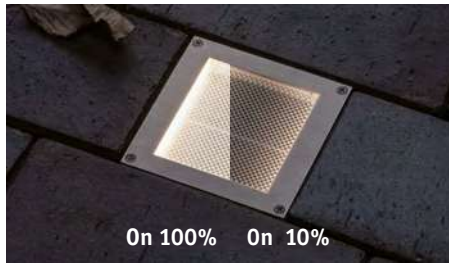

360°

1m

On 100% Time &lt;30 sec / On 10%

- ▶ Bodeneinbauleuchten Brick inkl. Bewegungsmelder
- ▶ Mit 500 kg belastbar
- ▶ Standard-Stein Maß von 10 x 10 bzw. 10 x 20 cm



- ▶ Encastrés de sol Brick avec détecteur de mouvement
- ▶ Charge supportée : 500 kg
- ▶ Pierre standard dans les dimensions 10 x 10 ou 10 x 20 cm



- ▶ Grondinbouwlampen Brick incl. bewegingsmelder
- ▶ Belastbaar tot 500 kg
- ▶ Standaard klinker van 10 x 10 of 10 x 20 cm

**Brick**

incl. 1x0,8W  
80 lm, 3.000 K  
230 V  
⌀42 ⇔100 ⌀100 mm  
EAN 4000870 943366

**943.36**

- 🔗 Alu/Grau 🗍 Metall/Edelstahl
- 🔗 Alu/Gris 🗍 Métal/Acier inoxydable
- 🔗 Alu/Grijs 🗍 Metaal/edelstaal

**Brick**

incl. 1x1,6W  
160 lm, 3.000 K  
230 V  
⌀42 ⇔200 ⌀100 mm  
EAN 4000870 943373

**943.37**

- 🔗 Alu/Grau 🗍 Metall/Edelstahl
- 🔗 Alu/Gris 🗍 Métal/Acier inoxydable
- 🔗 Alu/Grijs 🗍 Metaal/edelstaal

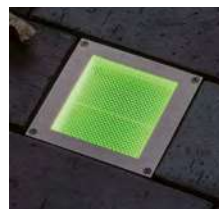
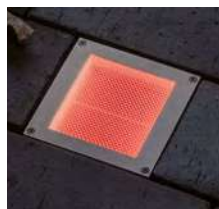

- ▶ Smarte Bodeneinbauleuchte Brick für Sicherheit und Orientierung auf allen Wegen oder für spektakuläre Lichteffekte rund ums Haus in RGB und tunable white
- ▶ Smart steuerbar per App, Sprache oder Fernbedienung
- ▶ Stufenlose Lichtfarbensteuerung per Zigbee-Fernbedienung, App oder Sprache
- ▶ Mit 500 kg belastbar
- ▶ Standard-Stein Maß von 10 x 10 cm

- ▶ Encastré de sol intelligent Brick pour la sécurité et l'orientation dans toutes les allées ou pour des effets lumineux spectaculaires autour de la maison en RGB et tunable white
- ▶ Commande Smart par appli, voix ou télécommande
- ▶ Contrôle en continu de la température de couleur par télécommande Zigbee, application ou commande vocale
- ▶ Charge supportée : 500 kg
- ▶ Pierre standard dans les dimensions 10 x 10 cm

- ▶ Slimme grondinbouwlamp Brick voor veiligheid en oriëntatie op alle paden of voor spectaculaire lichteffecten rondom het huis in RGB en tunable white.
- ▶ Smart bestuurbaar via app, spraak of afstandsbediening
- ▶ Traploze lichtkleurbesturing met Zigbee-afstandsbediening, app of spraak
- ▶ Belastbaar tot 500 kg
- ▶ Standaard klinker van 10 x 10 cm

**Brick**

incl. 1x1W  
80 lm, 3.000 K  
230 V  
⌀42 mm  
EAN 4000870 945049  
**945.04 new**



- 🔗 Weiß 🗍 Kunststoff
- 🔗 Blanc 🗍 Matière plastique
- 🔗 Wit 🗍 Kunststof





- ▶ Mitgelieferter Diffusor ermöglicht wahlweise akzentuiertes oder diffuses Licht
- ▶ Betrieb direkt mit 230 V
- ▶ Le diffuseur inclus permet de sélectionner une lumière soutenue ou diffuse
- ▶ Fonctionnement direct avec 230 V
- ▶ Meegeleverde diffusor maakt naar keuze geaccentueerd of diffuus licht mogelijk
- ▶ Rechtstreeks bedrijft met 230 V



**Floor LED**

incl. 1x1,2 W  
 30 lm, 2.700 K  
 <math>\sphericalangle</math> 120°, 17 cd  
 230 V  
 <math>\updownarrow</math> 132 <math>\varnothing</math> 110 mm  
 EAN 4000870 937884  
**937.88**

- Edelstahl Metall
- Acier inoxydable Métal
- Edelstaal Metaal



incl. diffusor



Perfect match  
 □ = 401-402



Perfect match  
 □ = 431



- ▶ Mit unbestückter GU10-Fassung: Ausstrahlwinkel und Lichtfarbe des LED-Leuchtmittels frei wählbar und austauschbar
- ▶ Inkl. Einbaudose für sicheren Einbau und Entnahmemöglichkeit bei späterer Wartung
- ▶ Mit 500 kg belastbar
- ▶ Douille GU10 non fournie : angle de rayonnement et température de couleur de l'ampoule LED au choix et interchangeables
- ▶ Embase encastrée incluse pour une pose sécurisée et un démontage ultérieur éventuel en vue de l'entretien
- ▶ Charge supportée : 500 kg
- ▶ Niet-uitgeruste GU10-fitting: uitstralhoek en lichtkleur van het LED-verlichtingsmiddel vrij te kiezen en vervangbaar
- ▶ Incl. inbouwdoos voor een veilige inbouw en demontage bij later onderhoud
- ▶ Belastbaar tot 500 kg



**Floor**

max. 10 W, GU10  
 230 V  
 <math>\updownarrow</math> 130 <math>\varnothing</math> 110 mm  
 EAN 4000870 943908  
**943.90**

- Edelstahl Edelstahl
- Acier inoxydable Acier inoxydable
- Edelstaal edelstaal

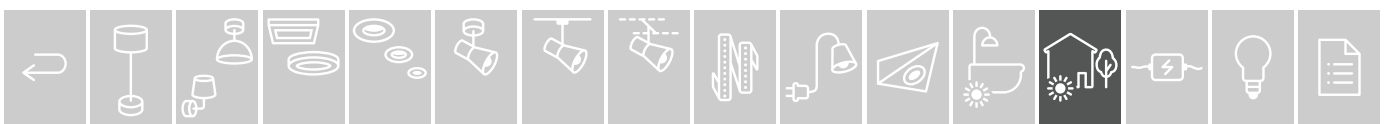



incl.



incl.



- Flexible, steckerfertige 230 V Poller Flarea für die Beleuchtung von Wegen, Plätzen oder Beetgrenzen
- Erdspieß für kinderleichte Fixierung in weichen Böden
- Borne Flarea 230 V flexible et prête à raccorder pour l'éclairage des allées, des places ou des bordures de massifs
- Piquet à planter pour une fixation simplissime dans les sols meubles
- De flexibele, aansluitklare 230V bolderlamp Flarea voor de verlichting van toegangswegen, specifieke plekken of borders
- Grondpen voor zeer gemakkelijke plaatsing in zachte ondergronden

**Flarea 200**

incl. 1×3,1 W  
360 lm, 3.000 K  
230 V  
∅200 ∅45 mm  
EAN 4000870 943847

**943.84**

🔧 Schwarz Aluminium  
🔧 Noir Aluminium  
🔧 Zwart Aluminium

**Flarea 400**

incl. 1×3,1 W  
360 lm, 3.000 K  
230 V  
∅400 ∅45 mm  
EAN 4000870 943854

**943.85**

🔧 Schwarz Aluminium  
🔧 Noir Aluminium  
🔧 Zwart Aluminium

**Flarea 600**

incl. 1×3,1 W  
360 lm, 3.000 K  
230 V  
∅600 ∅45 mm  
EAN 4000870 943861

**943.86**

🔧 Schwarz Aluminium  
🔧 Noir Aluminium  
🔧 Zwart Aluminium



- Attraktive Wegeleuchte für die Zuwegung - passend zu Wandleuchten Capea
- Luminaire d'allée attrayant pour les allées : adapté aux appliques Capea
- Aantrekkelijke padverlichting voor toegangswegen - geschikt voor wandlampen Capea

**Capea**

incl. 1×6 W  
600 lm, 3.000 K  
∠ 98°  
230 V  
∅500 ∅130 ∅172 mm  
EAN 4000870 944547

**944.54 new**

🔧 Grau Aluminium  
🔧 Gris Aluminium  
🔧 Grijs Aluminium





**Classic curved**

max. 12 W, E27  
230 V

∅280 ∅164 mm  
EAN 4000870 943939

**943.93**

- 🔗 Klar/Schwarz 📦 Kunststoff
- 🔗 Clair/Noir 📦 Matière plastique
- 🔗 Helder/Zwart 📦 Kunststof



- ▶ Pollerleuchte klassisch
- ▶ Ideal für Vollglas-Filament-Lampen im Retro-Look

- ▶ Borne lumineuse classique
- ▶ Idéal pour les lampes à incandescence tout en verre au look rétro

- ▶ Klassieke bolderlamp
- ▶ Ideaal voor glazen filamentlampen in retro-look



**Bollard Classic**

max. 15 W, E27  
230 V

∅500 ∅173 mm  
EAN 4000870 943977

**943.97**

- 🔗 Dunkelgrau 📦 Metall/Glas
- 🔗 Gris foncé 📦 Métal/Verre
- 🔗 Donkergrijs 📦 Metaal/Glas

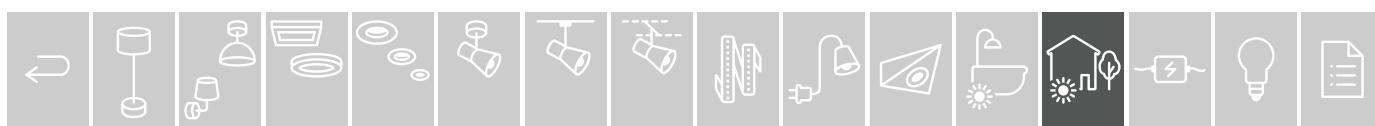



- ▶ Mit unbestückter GU10-Fassung: Ausstrahlwinkel und Lichtfarbe des LED-Leuchtmittels frei wählbar und austauschbar
- ▶ Douille GU10 non fournie : angle de rayonnement et température de couleur de l'ampoule LED au choix et interchangeables
- ▶ Niet-uitgeruste GU10-fitting: uitstralhoek en lichtkleur van het LED-verlichtingsmiddel vrij te kiezen en vervangbaar



#### Garden Spot

max. 28 W, GU10  
230 V  
⇄ 320 ø98 ⇄ 100 mm  
EAN 4000870 937518  
**937.51**

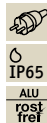

- ↳ Alu Alu
- ↳ Alu Alu
- ↳ Alu Alu



- ▶ Inkl. passendem GU10-Leuchtmittel
- ▶ Auch ohne Spieß als Aufbaustrahler für die Beleuchtung von Fassaden, Gartenhäusern und Terrassen verwendbar
- ▶ Ampoule GU10 compatible incluse
- ▶ Utilisable également sans piquet en tant que spot en saillie pour l'éclairage des façades, des abris de jardin et des terrasses
- ▶ Incl. geschikt GU10-verlichtingsmiddel
- ▶ Ook zonder spies te gebruiken als opbouwspot voor de verlichting van gevels, tuinhuisjes en terrassen.



#### Garden Spot

incl. 1x3,5 W, GU10  
230 lm, 3.000 K  
230 V  
⇄ 320 ø92 mm  
EAN 4000870 988961  
**988.96**



- ↳ Schwarz Alu
- ↳ Noir Alu
- ↳ Zwart Alu



#### Garden Spot

incl. 3x3,5 W, GU10  
3x230 lm, 3.000 K  
230 V  
⇄ 320 ø92 mm  
EAN 4000870 988978  
**988.97**



- ↳ Schwarz Alu
- ↳ Noir Alu
- ↳ Zwart Alu









120°  
2m  
Time ON 15 sec.

► Sehr lichtstarke Solar-Wandleuchten mit diffusem Licht für gleichmäßige Lichtverteilung und blendfreie Ausleuchtung

► Appliques solaires très puissantes à lumière diffuse pour une diffusion homogène de la lumière et un éclairage non éblouissant

► Zeer lichtsterke solar wandlampen met diffuus licht voor een gelijkmatige lichtverdeling en niet-verblindende uitlichting

**Solar Solveig**

incl. 1x4,8W  
350lm, 3.000 K  
4x18650 Akku/3,7V  
∅29 ↔105 ↗173 mm  
EAN 4000870 953938

**953.93 new**

🔗 Schwarz 📦 Kunststoff  
🔗 Noir 📦 Matière plastique  
🔗 Zwart 📦 Kunststof



► Attraktive Solar-Tischleuchte Lillesol  
► Mit Schnurschalter in 3-Stufen dimmbar

► Lampe à poser solaire Lillesol attrayante  
► Avec interrupteur à cordon à 3 niveaux de gradation

► Aantrekkelijke solar tafellamp Lillesol  
► Met snoerschakelaar in 3 standen dimbaar

**Solar Lillesol**

incl. 1x0,8W  
75lm, 3.000 K  
1x18650 Akku/3,7V  
∅280 mm  
EAN 4000870 943090

**943.09**

🔗 Edelstahl 📦 Kunststoff/Metall  
🔗 Acier inoxydable 📦 Matière plastique/Métal  
🔗 Edelstaal 📦 Kunststof/Metaal







180°  
8m  
Time ON 30 sec.

► Hohe Lumenleistung aus Sonnenenergie

► Fort rendement lumineux par l'énergie solaire

► Hoge lichtopbrengst uit zonne-energie



#### Solar Kiran

incl. 1×5 W  
600 lm, 3.000 K  
⌀69 ⇄350 ⌀186 mm  
EAN 4000870 943380

**943.38 new**

👉 Weiß 📦 Kunststoff  
👉 Blanc 📦 Matière plastique  
👉 Wit 📦 Kunststof



#### Solar Kiran

incl. 1×3 W  
400 lm, 3.000 K  
⌀65 ⇄300 ⌀168 mm  
EAN 4000870 943410

**943.41 new**

👉 Weiß 📦 Kunststoff  
👉 Blanc 📦 Matière plastique  
👉 Wit 📦 Kunststof



180°  
8m  
Time ON 30 sec.

► Hohe Lumenleistung aus Sonnenenergie

► Fort rendement lumineux par l'énergie solaire

► Hoge lichtopbrengst uit zonne-energie



#### Solar Kiran

incl. 1×5 W  
600 lm, 3.000 K  
⌀69 ⇄350 ⌀186 mm  
EAN 4000870 943397

**943.39 new**

👉 Anthrazit 📦 Kunststoff  
👉 Anthracite 📦 Matière plastique  
👉 Antraciet 📦 Kunststof



#### Solar Kiran

incl. 1×3 W  
400 lm, 3.000 K  
⌀65 ⇄300 ⌀168 mm  
EAN 4000870 943403

**943.40 new**

👉 Anthrazit 📦 Kunststoff  
👉 Anthracite 📦 Matière plastique  
👉 Antraciet 📦 Kunststof





- ▶ Der Clou: 350° drehbares Solarpanel ermöglicht ideale Ausrichtung für optimale Sonnenenergie-Aufnahme.
- ▶ Inkl. Lithium-Ionen Akku, Dämmerungssensor, Nachlichtfunktion und Bewegungsmelder.
- ▶ Ladezeit: 8h, Arbeitslicht 150lm: 1,5h, Orientierungslicht 10lm: 15h
- ▶ Le meilleur : panneau solaire rotatif à 350° permet une orientation idéale pour absorber parfaitement l'énergie solaire.
- ▶ Avec batterie lithium ion, détecteur crépusculaire, fonction veilleuse et détecteur de mouvement.
- ▶ Temps de charge : 8 h, éclairage de travail 150lm : 1,5 h, balisage 10lm : 15 h
- ▶ De clou: het 350° draaibare zonnepaneel is ideaal te richten voor een optimale opname van zonne-energie.
- ▶ Incl. lithium-ion-accu, schemersensor, nachlichtfunctie en bewegingsmelder.
- ▶ Oplaadtijd: 8 uur, werklucht 150lm: 1,5 uur, oriëntatielicht 10lm: 15 uur

**Solar Ilias**

incl. 1x1,2W  
115 lm, 3.000 K  
1x18650 Akku/3,7V  
⌀261 ⇄73 ⇄175 mm  
EAN 4000870 942604

**942.60**

- ↳ Anthrazit 田 Kunststoff
- ↳ Anthracite 田 Matière plastique
- ↳ Antraciet 田 Kunststof

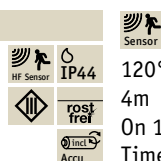

Sensor  
120°  
4m  
On 100% 10 sec.  
Time ON 10%.

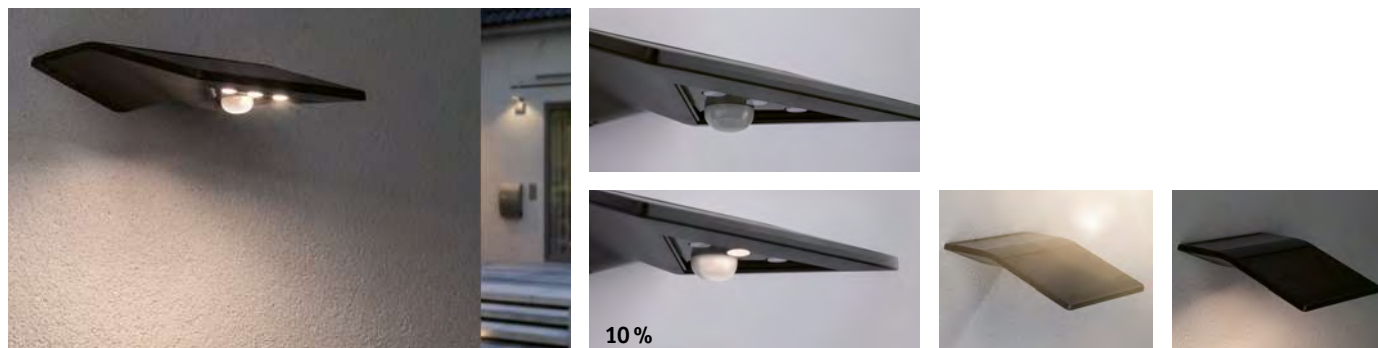
**Solar Yoko**

incl. 1x1,2W  
145 lm, 3.000 K  
1x18650 Akku/3,7V  
⌀57 ⇄160 ⇄190 mm  
EAN 4000870 942451

**942.45**

- ↳ Anthrazit 田 Kunststoff
- ↳ Anthracite 田 Matière plastique
- ↳ Antraciet 田 Kunststof



Sensor  
120°  
3m  
On 100% 10 sec.  
Time ON 10%.

**Solar Yoko Zigbee**

incl. 1x1W  
115 lm, 3.000 K  
1x18650 Akku/3,7V  
⌀57 ⇄160 ⇄190 mm  
EAN 4000870 942789

**942.78**

- ↳ Anthrazit 田 Kunststoff
- ↳ Anthracite 田 Matière plastique
- ↳ Antraciet 田 Kunststof



smart  
controllable  
**zigbee**

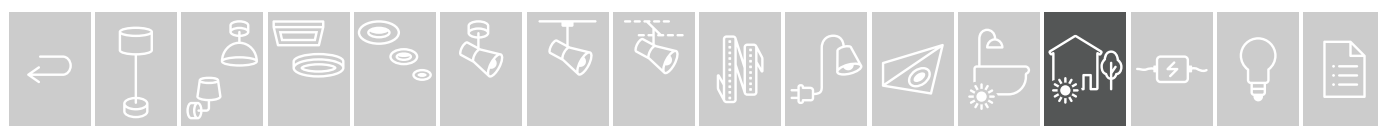

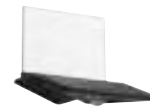
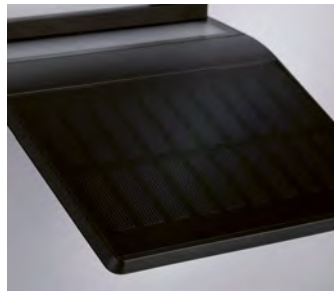

0123456789  
0123456789  
abcd

- ▶ Inkl. Lithium-Ionen Akku, Dämmerungssensor, Nachlichtfunktion und Bewegungsmelder
- ▶ Ladezeit: 8h, Arbeitslicht 150lm: 1,5h, Orientierungslicht 10lm: 15h
- ▶ Selbstklebender Nummern- und Buchstabensatz ist enthalten.
- ▶ Avec batterie lithium ion, détecteur crépusculaire, fonction veilleuse et détecteur de mouvement
- ▶ Temps de charge : 8 h, éclairage de travail 150lm : 1,5 h, balisage 10lm : 15 h
- ▶ Un jeu de numéros et de lettres adhésifs est fourni.
- ▶ Incl. lithium-ion-accu, schemersensor, nachlichtfunctie en bewegingsmelder
- ▶ Oplaadtijd: 8 uur, werklicht 150lm: 1,5 uur, oriëntatielicht 10lm: 15 uur
- ▶ Zelfklevende set nummers en letters wordt meegeleverd.



#### Solar Yoko

incl. 1x1,2W  
145 lm, 3.000 K  
1x18650 Akku/3,7V  
⌀175 ⇄160 ⌀190 mm  
EAN 4000870 942437

**942.43**

- 🌀 Anthrazit 🧺 Kunststoff
- 🌀 Anthracite 🧺 Matière plastique
- 🌀 Antraciet 🧺 Kunststof

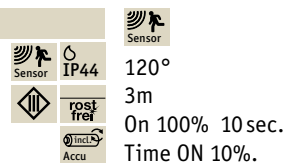



- ▶ Inkl. Lithium-Ionen Akku, Dämmerungssensor, Nachlichtfunktion und Bewegungsmelder
- ▶ Ladezeit: 8h, Arbeitslicht 150lm: 1,5h, Orientierungslicht 10lm: 15h

- ▶ Avec batterie lithium ion, détecteur crépusculaire, fonction veilleuse et détecteur de mouvement
- ▶ Temps de charge : 8 h, éclairage de travail 150lm : 1,5 h, balisage 10lm : 15 h

- ▶ Incl. lithium-ion-accu, schemersensor, nachlichtfunctie en bewegingsmelder
- ▶ Oplaadtijd: 8 uur, werklicht 150lm: 1,5 uur, oriëntatielicht 10lm: 15 uur



### Solar Soley

incl. 1x1,22 W  
150 lm, 3.000 K  
1x18650 Akku/3,7V  
∅100 ⇄104 ↗240 mm  
EAN 4000870 942505



120°

3m

On 100% 10sec.  
Time ON 10%.

- ↳ Anthrazit 

--	--	--	--

 Kunststoff/Metall
- ↳ Anthracite 

--	--	--	--

 Matière plastique/Métal
- ↳ Antraciet 

--	--	--	--

 Kunststof/Metaal



### Solar Soley

incl. 1x1,22 W  
150 lm, 3.000 K  
1x18650 Akku/3,7V  
∅100 ⇄104 ↗240 mm  
EAN 4000870 942512



120°

3m

On 100% 10sec.  
Time ON 10%.

- ↳ Weiß 

--	--	--	--

 Kunststoff/Metall
- ↳ Blanc 

--	--	--	--

 Matière plastique/Métal
- ↳ Wit 

--	--	--	--

 Kunststof/Metaal



### Solar Soley Zigbee

incl. 1x1 W  
115 lm, 3.000 K  
1x18650 Akku/3,7V  
∅100 ⇄104 ↗240 mm  
EAN 4000870 942796



- ↳ Anthrazit 

--	--	--	--

 Kunststoff/Metall
- ↳ Anthracite 

--	--	--	--

 Matière plastique/Métal
- ↳ Antraciet 

--	--	--	--

 Kunststof/Metaal



- ▶ Hausnummernmodul für Wandleuchte Soley
- ▶ Selbstklebender Nummern- und Buchstabensatz ist enthalten.

- ▶ Module de numéros de maison pour applique Soley
- ▶ Un jeu de numéros et de lettres adhésifs est fourni.

- ▶ Huisnummermodule voor wandlamp Soley
- ▶ Zelfklevende set nummers en letters wordt meegeleverd.



### Soley House number

∅134 ⇄120 ↗2 mm  
EAN 4000870 942536



942.53

- ↳ Transparent 

--	--	--	--

 Kunststoff
- ↳ Transparent 

--	--	--	--

 Matière plastique
- ↳ Transparant 

--	--	--	--

 Kunststof

0123456789  
0123456789  
abcd

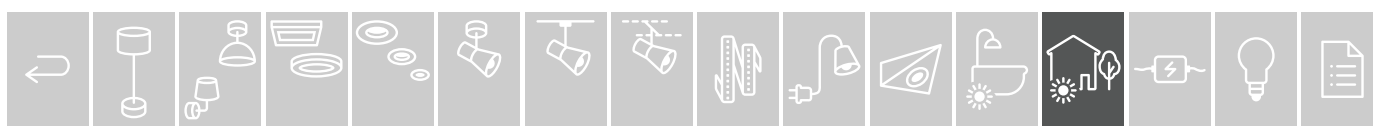



- Sehr lichtstarke Solar-Wandleuchten mit diffusem Licht für gleichmäßige Lichtverteilung und blendfreie Ausleuchtung

- Appliques solaires très puissantes à lumière diffuse pour une diffusion homogène de la lumière et un éclairage non éblouissant

- Zeer lichtsterke solar wandlampen met diffuus licht voor een gelijkmatige lichtverdeling en niet-verblindende uitlichting

**Solar Solweig**

incl. 1x5 W  
600 lm, 3.000 K  
1x18650 Akku/3,7V  
⇅100 ⇄200 ↗130 mm  
EAN 4000870 945056



Sensor

110°

8m

On 100%. ⚙️ Schwarz 🧺 Kunststoff  
Time ON 3%. ⚙️ Noir 🧺 Matière plastique  
⚙️ Zwart 🧺 Kunststof

**Solar Eileen**

incl. 1x5,5 W  
600 lm, 3.000 K  
1x18650 Akku/3,7V  
⇅65 ⇄175 ↗198 mm  
EAN 4000870 945704



Sensor

110°

8m

On 100%. ⚙️ Schwarz 🧺 Kunststoff  
Time ON 3%. ⚙️ Noir 🧺 Matière plastique  
⚙️ Zwart 🧺 Kunststof

**Solar Adya**

incl. 1x2,5 W  
300 lm, 3.000 K  
1x18650 Akku/3,7V  
⇅60 ⇄180 ↗118 mm  
EAN 4000870 945711



Sensor

110°

8m

On 100%. ⚙️ Schwarz 🧺 Kunststoff  
Time ON 3%. ⚙️ Noir 🧺 Matière plastique  
⚙️ Zwart 🧺 Kunststof

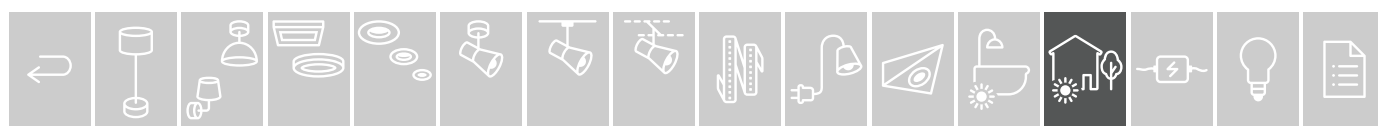



Sensor  
120°  
2m  
Time ON 10sec.

- ▶ Inkl. Lithium-Ionen Akku und Bewegungsmelder
- ▶ Ladezeit: 8h, Arbeitslicht 150lm: 4h

- ▶ Avec batterie lithium ion et détecteur de mouvement
- ▶ Temps de charge : 8 h, éclairage de travail 150lm : 4 h

- ▶ Incl. lithium-ion-accu en bewegingsmelder
- ▶ Oplaaftijd: 8 uur, werklicht 150lm: 4 uur



### Solar Ryse

incl. 1x1,2W  
145 lm, 3.000 K  
1x18650 Akku/3,7V  
⌀41 ⇄154 ↗147 mm  
EAN 4000870 942468

**942.46**

- ↳ Anthrazit Kunststoff
- ↳ Anthracite Matière plastique
- ↳ Antraciet Kunststof



### Solar Ryse

incl. 1x1,2W  
145 lm, 3.000 K  
1x18650 Akku/3,7V  
⌀41 ⇄154 ↗147 mm  
EAN 4000870 942475

**942.47**

- ↳ Weiß Kunststoff
- ↳ Blanc Matière plastique
- ↳ Wit Kunststof



Sensor  
120°  
4m



### Solar Eloise

incl. 1x1 W  
100 lm, 3.000 K  
1x14500/ 3,7V  
ø220 ↗50 mm  
EAN 4000870 942642

**942.64**

- ↳ Anthrazit Kunststoff
- ↳ Anthracite Matière plastique
- ↳ Antraciet Kunststof

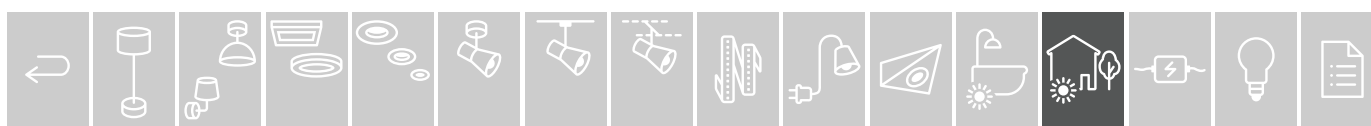



120°  
3 m  
On 100%.  
Time <3Sec.



### Solar Helena

incl. 1x3 W  
300lm, 3.000 K  
1x18650 Akku/3,7V  
ø176 ↗62 mm  
EAN 4000870 942659

**942.65**

↳ Anthrazit Kunststoff  
↳ Anthracite Matière plastique  
↳ Antraciet Kunststof



110°  
8m  
On 100%.  
Time ON 3%.

▶ LED-Technik mit gleichmäßiger, diffuser Lichtverteilung in nostalgischer Laternenoptik

▶ Technologie LED avec une répartition diffuse et homogène de la lumière dans le style nostalgique des lanternes d'antan

▶ LED-techniek met gelijkmatige, diffuse lichtverdeling in nostalgische lantaarnlook



### Solar Marisol

incl. 1x5,5 W  
600lm, 3.000 K  
1x18650 Akku/3,7V  
↕270 ↔150 ↗180 mm  
EAN 4000870 945728

**945.72 new**

↳ Schwarz Kunststoff  
↳ Noir Matière plastique  
↳ Zwart Kunststof

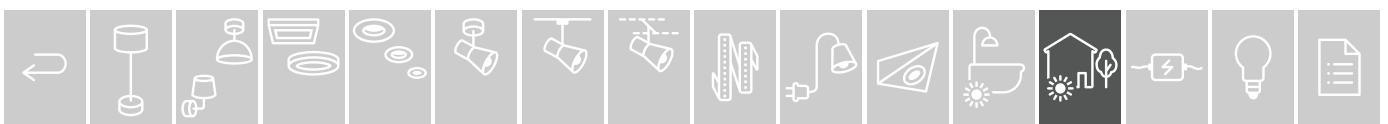

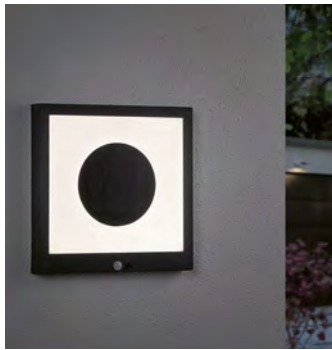

120°

4m

On &lt; 30Lux / Off &gt; 30Lux

Time ON &lt; 20 sec.

- ▶ Solar-Panel-Leuchten mit Bewegungsmelder
- ▶ Vier verschiedene Funktionen einstellbar
- ▶ Luminaires à cellule solaire avec détecteur de mouvement
- ▶ Quatre fonctions différentes configurables
- ▶ Solar paneelarmaturen met bewegingsmelder
- ▶ Vier verschillende functies instelbaar

**Solar Taija**

incl. 1x1,2 W  
120 lm, 3.000 K  
1x18650 Akku/3,7V  
∅300 ↔300 ∇45 mm  
EAN 4000870 942635

**942.63**

- ↳ Anthrazit Metall
- ↳ Anthracite Métal
- ↳ Antraciet Metaal

**Solar Panel Taija**

incl. 1x2 W  
200 lm, 3.000 K  
1x18650 Akku/3,7V  
∅400 ↔400 ∇42 mm  
EAN 4000870 943106

**943.10**

- ↳ Anthrazit Metall
- ↳ Anthracite Métal
- ↳ Antraciet Metaal

**Solar Panel Taija**

incl. 1x1,8 W  
180 lm, 3.000 K  
1x18650 Akku/3,7V  
∅600 ↔300 ∇42 mm  
EAN 4000870 943113

**943.11**

- ↳ Anthrazit Metall
- ↳ Anthracite Métal
- ↳ Antraciet Metaal

0101234  
56756789  
ABCDE**Solar Dayton**

incl. 1x0,05 W  
6 lm, 3.000 K  
1xAA-Akku/1,5V (Mignon)  
4,8 V  
∅175 ↔225 ∇63 mm  
EAN 4000870 953884

**953.88 new**

- ↳ Schwarz Kunststoff
- ↳ Noir Matière plastique
- ↳ Zwart Kunststof







- ▶ Ladezeit bei Sonnenausrichtung 6-8 Stunden, Leuchtdauer 4-6 Std.
- ▶ Inkl. Dämmerungssensor, schaltet erst bei Dunkelheit ein
- ▶ Selbstklebender Nummern- und Buchstabensatz ist enthalten
- ▶ Durée de recharge à la lumière solaire 6-8 heures, durée d'éclairage 4-6 heures
- ▶ Avec détecteur crépusculaire, s'allume seulement dans l'obscurité
- ▶ Un jeu de numéros et de lettres adhésifs est fourni
- ▶ Oplaadtijd via zonne-energie 6-8 uur, gebruikstijd 4-6 uur
- ▶ Incl. schemersensor, schakelt pas in wanneer het donker is
- ▶ Zelfklevende set nummers en letters wordt meegeleverd



#### Solar House Number

incl. 1x0,2 W  
3.000 K  
2xAA-Akku/1,5V (Mignon)  
∅220 ↔230 ∅60 mm  
EAN 4000870 937655

**937.65**

🔗 Edeltahl/Weiß 🏠 Edeltahl/Acryl  
🔗 Acier inoxydable/Blanc  
🏠 Acier inoxydable/Acryl  
🔗 Edeltahl/Wit 🏠 edeltahl/Acryl



90°  
3m  
On < 20Lux 10% / Off > 20Lux  
Time ON < 20sec.

- ▶ Hausnummernleuchte beleuchtet nach oben die Hausnummer und nach unten die Hauswand
- ▶ Le numéro de maison lumineux éclaire en contre-plongée le numéro de la maison et en plongée le mur de la maison
- ▶ De huisnummervelichting verlicht aan de bovenkant het huisnummer en aan de onderkant de huismuur



#### Solar Neda

incl. 1x1 W  
80 lm, 3.000 K  
1x18650 Akku/3,7V  
∅37 ↔163 ∅226 mm  
EAN 4000870 945773

**945.77 new**

🔗 Anthrazit 🏠 Kunststoff  
🔗 Anthracite 🏠 Matière plastique  
🔗 Antraciet 🏠 Kunststof

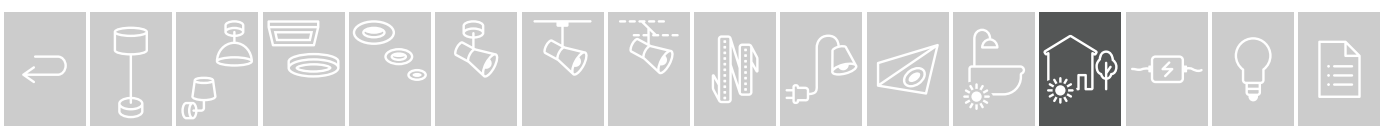

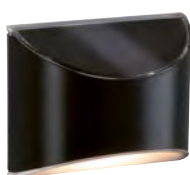

- ▶ Orientierungs- und Wegeleuchten
- ▶ Inkl. Dämmerungssensor, schaltet erst bei Dunkelheit ein
- ▶ Ladezeit: 12h, Betriebsdauer: 8h
- ▶ Éclairage de balisage et d'allées
- ▶ Avec détecteur crépusculaire, s'allume seulement dans l'obscurité
- ▶ Temps de charge : 12 h, durée de fonctionnement : 8 h
- ▶ Oriëntatielicht en wegverlichting
- ▶ Incl. schemersensor, schakelt pas in wanneer het donker is
- ▶ Oplaadtijd: 12 uur, gebruiksduur: 8 uur

**Solar Way Elliot**

incl. 1x0,05 W  
7 lm, 3.000 K  
1xAA-Akku/1,5V (Mignon)  
∅80 ⇔100 ↗53 mm  
EAN 4000870 942338  
**942.33**



↳ Anthrazit ▣ Kunststoff  
↳ Anthracite ▣ Matière plastique  
↳ Antraciet ▣ Kunststof

**Solar Way Dayton**

incl. 1x0,05 W  
4 lm, 3.000 K  
1xAAA-Akku/1,5V (Micro)  
∅80 ⇔100 ↗20 mm  
EAN 4000870 942345  
**942.34**



↳ Anthrazit ▣ Kunststoff  
↳ Anthracite ▣ Matière plastique  
↳ Antraciet ▣ Kunststof

**Solar Way Mimmo**

incl. 1x1,2 W  
20 lm, 6.500 K  
∅63 ⇔90 ↗50 mm  
EAN 4000870 946664  
**946.66 new**



↳ Schwarz ▣ Kunststoff  
↳ Noir ▣ Matière plastique  
↳ Zwart ▣ Kunststof

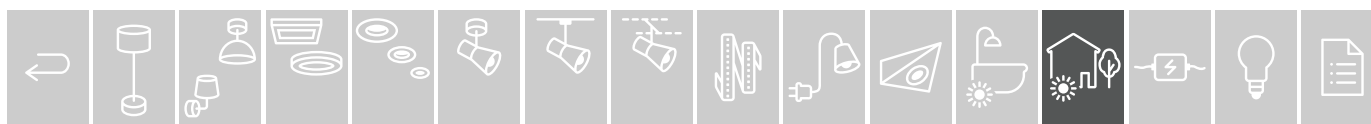

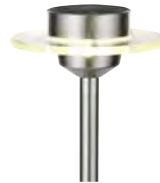

- ▶ Ladezeit bei Sonnenausrichtung 6-8 Stunden, Leuchtdauer 3-5 Std.
- ▶ Durée de recharge à la lumière solaire 6-8 heures, durée d'éclairage 3-5 heures
- ▶ Oplaadtijd via zonne-energie 6-8 uur, gebruikstijd 3-5 uur.



### Solar Ufo

incl. 1x0,2 W  
3.000 K  
2xAAA-Akku/1,5V (Micro)  
±550 ø150 mm  
EAN 4000870 937648

**937.64**

↳ Edelstahl/Klar ▣ Edelstahl/Glas  
↳ Acier inoxydable/Clair ▣ Acier inoxydable/  
Verre ↳ Edelstaal/Helder ▣ edelstaal/Glas



Sensor  
120°  
1,5m  
On 10 sec.

- ▶ Inkl. Lithium-Ionen Akku und Bewegungsmelder
- ▶ Avec batterie lithium ion et détecteur de mouvement
- ▶ Incl. lithium-ion-accu en bewegingsmelder
- ▶ Ladezeit: 8h, Arbeitslicht 150lm: 4h
- ▶ Temps de charge : 8 h, éclairage de travail 150lm : 4 h
- ▶ Oplaadtijd: 8 uur, werklicht 150lm: 4 uur



### Solar Ryse

incl. 1x1,2 W  
145 lm, 3.000 K  
1x18650 Akku/3,7V  
±796 ↔154 ↗194 mm  
EAN 4000870 942499

**942.49**

↳ Anthrazit ▣ Kunststoff/Metall  
↳ Anthracite ▣ Matière plastique/Métal  
↳ Antraciet ▣ Kunststof/Metaal

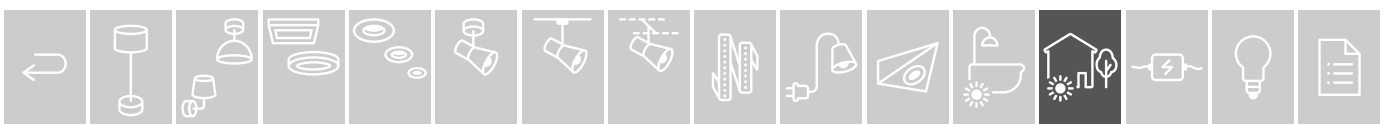



120°  
3m  
On 100% 10sec.  
Time ON 10%.

- ▶ Der Clou: 350° drehbares Solarpanel ermöglicht ideale Ausrichtung für optimale Sonnenenergie-Aufnahme.
- ▶ Inkl. Lithium-Ionen Akku, Dämmerungssensor, Nachlichtfunktion und Bewegungsmelder.
- ▶ Ladezeit: 8h, Arbeitslicht 150lm: 1,5h, Orientierungslicht 10lm: 15h
- ▶ Le meilleur : panneau solaire rotatif à 350° permet une orientation idéale pour absorber parfaitement l'énergie solaire.
- ▶ Avec batterie lithium ion, détecteur crépusculaire, fonction veilleuse et détecteur de mouvement.
- ▶ Temps de charge : 8 h, éclairage de travail 150lm : 1,5 h, balisage 10lm : 15 h
- ▶ De clou: het 350° draaibare zonnepaneel is ideaal te richten voor een optimale opname van zonne-energie.
- ▶ Incl. lithium-ion-accu, schemersensor, nachlichtfunctie en bewegingsmelder.
- ▶ Oplaadtijd: 8 uur, werklucht 150lm: 1,5 uur, oriëntatielicht 10lm: 15 uur

**Solar Ilias**

incl. 1x1,2W  
115 lm, 3.000 K  
1x18650 Akku/3,7V  
∅720 ⇄73 ⇄179 mm  
EAN 4000870 942628

**942.62**

- 🔧 Anthrazit 🧱 Kunststoff
- 🔧 Anthracite 🧱 Matière plastique
- 🔧 Antraciet 🧱 Kunststof



110°  
8m  
On 100%.  
Time ON 3%.

- ▶ LED-Technik mit gleichmäßiger, diffuser Lichtverteilung in nostalgischer Laternenoptik
- ▶ Technologie LED avec une répartition diffuse et homogène de la lumière dans le style nostalgique des lanternes d'antan
- ▶ LED-techniek met gelijkmatige, diffuse lichtverdeling in nostalgische lantaarnlook

**Solar\_Marisol**

incl. 1x5,5W  
600 lm, 3.000 K  
1x18650 Akku/3,7V  
∅400 ⇄150 ⇄150 mm  
EAN 4000870 945735

**945.73 new**

- 🔧 Schwarz 🧱 Kunststoff
- 🔧 Noir 🧱 Matière plastique
- 🔧 Zwart 🧱 Kunststof

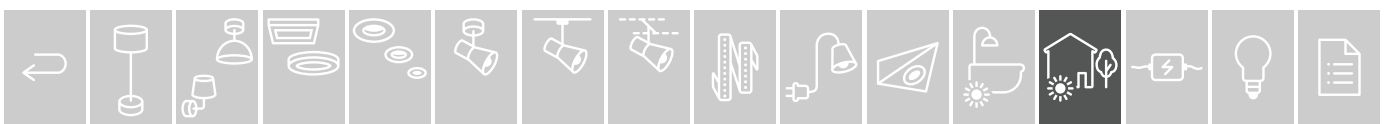



- ▶ Inkl. Lithium-Ionen Akku, Dämmerungssensor, Nachlichtfunktion und Bewegungsmelder.
- ▶ Ladezeit: 8h, Arbeitslicht 150lm: 1,5h, Orientierungslicht 10lm: 15h
- ▶ Avec batterie lithium ion, détecteur crépusculaire, fonction veilleuse et détecteur de mouvement.
- ▶ Temps de charge : 8 h, éclairage de travail 150lm : 1,5 h, balisage 10lm : 15 h
- ▶ Incl. lithium-ion-accu, schemersensor, nachlichtfunctie en bewegingsmelder.
- ▶ Oplaadtijd: 8 uur, werklicht 150lm: 1,5 uur, oriëntatielicht 10lm: 15 uur



### Solar Soley

incl. 1x1,22 W  
150 lm, 3.000 K  
1x18650 Akku/3,7V  
∅848 ⇄100 ↗128 mm  
EAN 4000870 942529

**942.52**

↳ Anthrazit Kunststoff/Metall  
↳ Anthracite Matière plastique/Métal  
↳ Antraciet Kunststof/Metaal



Sensor  
120°  
3m  
On 100% 10 sec.  
Time ON 10%.



### Solar Soley Zigbee

incl. 1x1 W  
115 lm, 3.000 K  
1x18650 Akku/3,7V  
∅848 ⇄100 ↗128 mm  
EAN 4000870 942802

**942.80**

↳ Anthrazit Kunststoff/Metall  
↳ Anthracite Matière plastique/Métal  
↳ Antraciet Kunststof/Metaal



smart  
controllable  
 zigbee

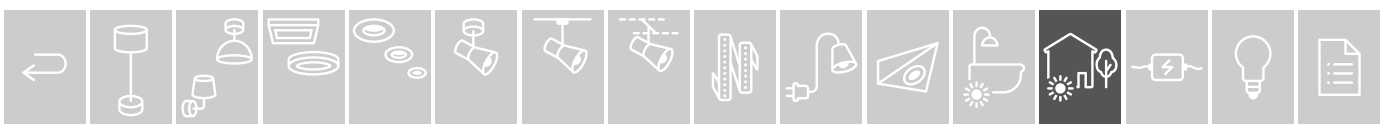

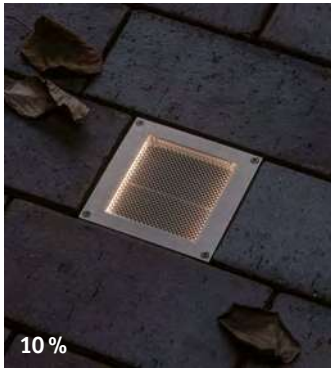

10 %

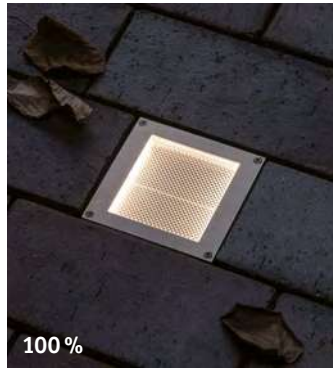

100 %



10 %



100 %



360°  
1m  
On 100% 10 sec.  
Time ON 10%.

- ▶ Boden-EBL mit Orientierungslicht und Bewegungsmelder
- ▶ Die Bodeneinbauleuchte ist dank Schutzart IP67 garantiert wasserdicht, rostfrei und für den Einbau in begehbaren Außenbereichen geeignet - bis zu 500kg belastbar
- ▶ Praktische Helfer Dank cleverer Zusatzfunktionen: Bewegungsmelder, Dämmerungssensor und Orientierungslicht-Funktion
- ▶ Ladezeit: 8h, Arbeitslicht 50lm / 160lm: >1h, Orientierungslicht 5lm: 12h
- ▶ Encastré de sol avec balisage et détecteur de mouvement
- ▶ Grâce à l'indice de protection IP67, cet encastré de sol est étanche et inoxydable et convient de surcroît aux lieux extérieurs praticables - charge supportée jusqu'à 500 kg
- ▶ Auxiliaire pratique grâce à ses fonctions supplémentaires : détecteur de mouvement, détecteur crépusculaire, fonction balisage
- ▶ Temps de charge 8 h, éclairage de travail 50lm / 160lm : >1 h, balisage 5lm : 12 h
- ▶ Grondinbouwlampen met oriëntatieverlichting en bewegingsmelder
- ▶ De grondinbouwlamp is dankzij beschermingsgraad IP67 gegarandeerd waterdicht, roestvast en geschikt voor de inbouw in berijdbare zones buitenshuis - tot 500 kg belastbaar
- ▶ Praktische hulpmiddelen dankzij slimme extra functies: bewegingsmelder, schemersensor en oriëntatielicht-functie
- ▶ Oplaadtijd: 8 uur, werklucht 50lm / 160lm: >1 uur, oriëntatielicht 5lm: 12 uur



**Solar Aron**

incl. 1x0,7W  
50lm, 3.000K  
1x18650 Akku/3,7V  
∅42 ⇔100 ∅100mm  
EAN 4000870 942383

**942.38**

- ☞ Weiß ▣Edelstahl/Kunststoff
- ☞ Blanc ▣Acier inoxydable/Matière plastique
- ☞ Wit ▣edelstaal/Kunststof



**Solar Aron**

incl. 1x1,5W  
160 lm, 3.000 K  
1x18650 Akku/3,7V  
∅42 ⇔200 ∅100mm  
EAN 4000870 942390

**942.39**

- ☞ Weiß ▣Edelstahl/Kunststoff
- ☞ Blanc ▣Acier inoxydable/Matière plastique
- ☞ Wit ▣edelstaal/Kunststof







- ▶ Bodeneinbauleuchten mit diffusem Licht für gleichmäßiges Orientierungslicht vom Boden aus
- ▶ Passend für übliche Pflastersteinmaße
- ▶ Encastrés de sol avec lumière diffuse pour une orientation homogène de la lumière depuis le sol
- ▶ Convient aux dimensions standard des pavés
- ▶ Grondinbouwlampen met diffuus licht voor gelijkmatige oriëntatieverlichting vanaf de grond
- ▶ Geschikt voor standaard klinkers

**Solar Domenic**

incl. 1x0,1W  
8lm, 3.000K  
1xNiMh 1,2V AA  
∅37 ↔80 ↗80 mm  
EAN 4000870 945780

**945.78 new**

- 🔧 Schwarz 📦 Kunststoff
- 🔧 Noir 📦 Matière plastique
- 🔧 Zwart 📦 Kunststof

**Solar Domenic**

incl. 1x0,1W  
8lm, 3.000K  
1x18650 Akku/3,7V  
∅37 ↔200 ↗80 mm  
EAN 4000870 945766

**945.76 new**

- 🔧 Schwarz 📦 Kunststoff
- 🔧 Noir 📦 Matière plastique
- 🔧 Zwart 📦 Kunststof

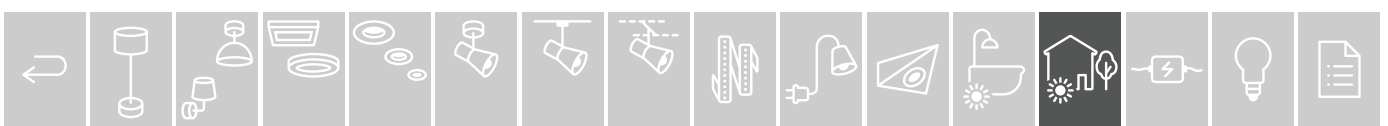





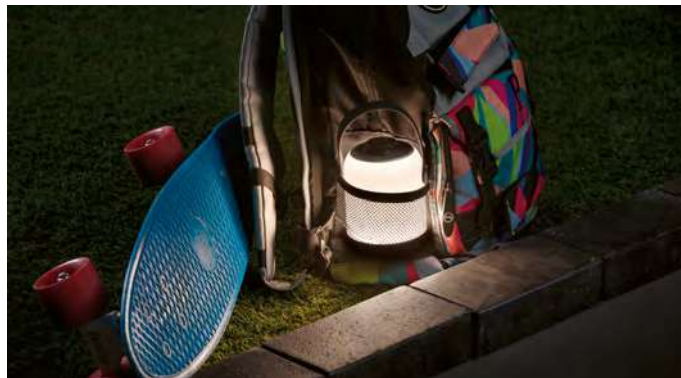

▶ Ladbar über USB mit externem Netzteil oder Powerbank

▶ Rechargeable par USB à l'aide de l'alimentation externe ou de la station de recharge

▶ Opladbaar via USB met extern netdeel of powerbank



**Mobile Accu Lamp Cupulino**

incl. 1x1,3 W  
135 lm, 3.000 K  
1x18650 Akku/3,7V  
DC 5 V  
∅184 ø83 mm  
EAN 4000870 942673

**942.67**

- 🔗 Transparent/Anthrazit
- 🔗 Transparent/Anthracite
- 🔗 Matière plastique
- 🔗 Transparant/Antraciet



**Mobile Accu Tablelamp Clutch**

incl. 1x1,6 W  
172 lm, 3.000 K  
1x18650 Akku/3,7V  
DC 5 V  
∅120 ø85 mm  
EAN 4000870 942109

**942.10**

- 🔗 Grau
- 🔗 Gris
- 🔗 Grijs



**Mobile Akku Worklight 5W IP65**

incl. 1x5 W  
440 lm, 6.500 K  
∠ 80°  
1x18650 Akku/3,7V  
DC 5 V  
∅131 ∅171 ∅39 mm  
EAN 4000870 942871

**942.87**

- 🔗 Schwarz/Rot
- 🔗 Noir/Rouge
- 🔗 Zwart/Rood



**Mobile Akku Worklight 15W IP65**

incl. 1x15 W  
1.200 lm, 6.500 K  
∠ 80°  
1x18650 Akku/3,7V  
DC 5 V  
∅131 ∅171 ∅39 mm  
EAN 4000870 942888

**942.88**

- 🔗 Schwarz/Rot
- 🔗 Noir/Rouge
- 🔗 Zwart/Rood

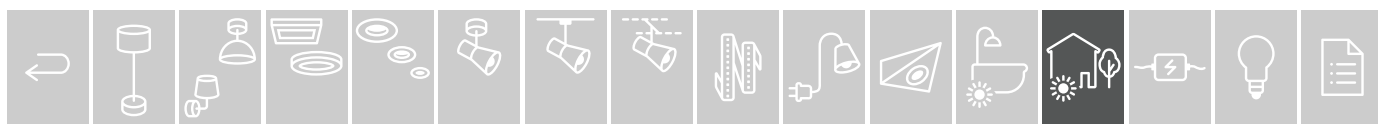



- ▶ Mini USB Anschluss und Kabel zum Laden des Akkus oder zum Betrieb der Leuchte bei leerem Akku mit einem externen Netzteil oder einer Powerbank
- ▶ Avec mini port USB et câble de recharge de batterie ou pour fonctionnement du luminaire sur bloc d'alimentation externe ou station de recharge, en cas de batterie vide
- ▶ Mini USB-aansluiting en kabel voor het opladen van de accu of voor gebruik van de armatuur bij lege accu met een extern netdeel of een powerbank



**Mobile Lampion Chain**

incl. 7x0,02 W  
7x1 lm, 3.000 K  
1x18650 Akku/3,7V  
DC 5 V  
ø73 mm ↔3,6 m  
EAN 4000870 941669

**941.66**

- ↳ Weiß 田 Kunststoff
- ↳ Blanc 田 Matière plastique
- ↳ Wit 田 Kunststof



**Mobile Lampion**

incl. 1x0,2 W  
16 lm, 3.000 K  
1x14500/ 3,7V  
DC 5 V  
∅170 ø140 mm  
EAN 4000870 941690

**941.69**

- ↳ Weiß/Grau 田 Kunststoff
- ↳ Blanc/Gris 田 Matière plastique
- ↳ Wit/Grijs 田 Kunststof



- ▶ LED-Strip für Sonnenschirmbeleuchtung
- ▶ Betrieb mit Powerbank
- ▶ Für indirektes Licht am Sitzplatz im Garten oder auf der Terrasse
- ▶ Selbstklebend
- ▶ Strip LED pour parasols
- ▶ Fonctionnement sur station de recharge
- ▶ Pour une lumière indirecte quand on est assis dans le jardin ou sur la terrasse
- ▶ Autocollant
- ▶ LED-Strip voor parasolverlichting
- ▶ Gebruik met powerbank
- ▶ Voor indirect licht bij het zitten in de tuin of op het terras
- ▶ Zelfklevend



**Mobile Parasol Light**

incl. 4x0,45 W  
4x30 lm, 3.000 K  
DC 5 V  
∅3 mm ↔400 mm ↗5 mm ↔4x0,4 m  
EAN 4000870 942086

**942.08**

- ↳ Schwarz 田 Kunststoff
- ↳ Noir 田 Matière plastique
- ↳ Zwart 田 Kunststof



# Transformers



DE Transformatoren für jedes Projekt  
FR Des transformateurs pour chaque projet  
NL Transformatoren voor elk project

DE Unsere hochwertigen Transformatoren bieten Lösungen für jede Anwendung – Vom Unterputzmodell für Einbauleuchten über Power Supplies für LED-Strips oder Ringkerntrafos für Seilsysteme. Durch Schutzfunktionen wie Überlastschutz, Temperaturwächter oder Kurzschlusschutz ist eine lange Produktlebensdauer und der sichere Betrieb gewährleistet.

FR Nos transformateurs de haute qualité offrent des solutions pour chaque application - des modèles encastrés pour les luminaires encastrés aux alimentations pour les bandes de LED ou aux transformateurs toroïdaux pour les systèmes de câbles. Les fonctions de protection telles que la protection contre les surcharges, les contrôleurs de température ou la protection contre les courts-circuits garantissent une longue durée de vie du produit et un fonctionnement sûr.

NL Onze hoogwaardige transformatoren bieden oplossingen voor elke toepassing - van inbouwmodellen voor inbouwarmaturen tot voedingen voor LED-strips of ringkern-transformatoren voor kabelsystemen. Beschermende functies zoals overbelasting-sbeveiliging, temperatuurbewaking of kortsluitbeveiliging zorgen voor een lange levensduur van het product en een veilige werking.



📖 = 387

DE Clevere Lösungen für wenig Platz  
FR Des solutions intelligentes pour un espace limité  
NL Slimme oplossingen voor beperkte ruimte



📖 = 389

DE Einfach von Halogen auf LED umrüsten  
FR Conversion simple de l'halogène en LED  
NL Eenvoudige conversie van halogeen naar LED beperkte ruimte

📖 = 390



DE Passende Modelle für LED-Strips  
FR Modèles appropriés pour les bandes LED  
NL Geschikte modellen voor LED-strips

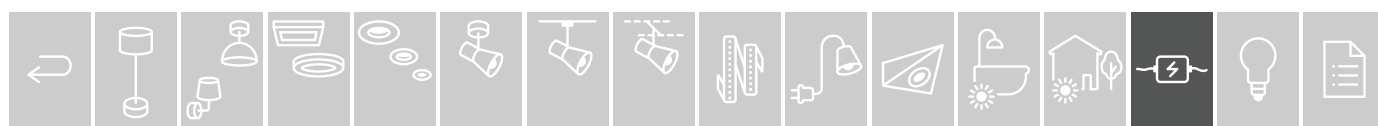

## VDE Disc Transformer 230/12V



- ▶ Disctrafos passen durch kreisrunde Bohrlöcher
- ▶ Dimmbar mit allen Dimmern (Phasen- und -abschnitt)
- ▶ Les transformateurs Disctrafos sont adaptés à la forme circulaire des alésages
- ▶ Possibilité de variation crépusculaire avec tous les gradateurs (découpage début et fin de phase)
- ▶ Disc-trafo's passen door de cirkelvormige boorgaten
- ▶ Dimbaar met alle dimmers (fase aan- en afsnijding)

**230/12V, 70 VA**

max. 20-70 W  
 ⌀23 ø55 mm  
 EAN 4000870 977286  
**977.28**

**230/12V, 105 VA**

max. 35-105 W  
 ⌀25 ø75 mm  
 EAN 4000870 977293  
**977.29**



## VDE Mipro Transformer 230/12V

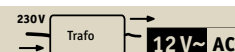

- ▶ Miprotrafos sind auf minimale Abmessungen konzipiert, sie passen in kleinste Montageräume
- ▶ Ideal für Einbauleuchten
- ▶ Einsetzbar bis zu 50° Umgebungstemperatur
- ▶ Dimmbar mit allen Dimmern (Phasen- und -abschnitt)
- ▶ Les transformateurs Miprotrafos aux dimensions réduites sont spécialement conçus pour les espaces de montages étroits
- ▶ Convient aux luminaires encastrés
- ▶ Supporte une température ambiante max. de 50°
- ▶ Possibilité de variation crépusculaire avec tous les gradateurs (découpage début et fin de phase)
- ▶ Miprotrafo's zijn ontworpen voor minimale afmetingen, ze passen in de kleinste montageruimtes
- ▶ Ideaal voor inbouwlampen
- ▶ Te gebruiken tot een omgevingstemperatuur van 50°
- ▶ Dimbaar met alle dimmers (fase aan- en afsnijding)

**230/12V, 70 VA**

max. 20-70 W  
 ⌀23 ⇄36 ⌀127 mm  
 EAN 4000870 977514  
**977.51**

**230/12V, 105 VA**

max. 35-105 W  
 ⌀30 ⇄38 ⌀137 mm  
 EAN 4000870 977538  
**977.53**

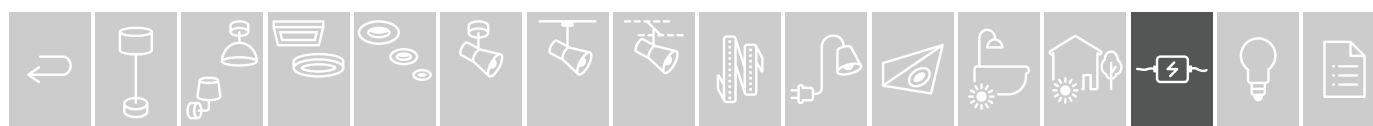

## VDE Flat Transformer 230/12V

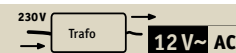

- ▶ Flattrafos brauchen eine Einbauhöhe von nur 24 mm
- ▶ Problemlöser bei gering abgehängten Decken
- ▶ Ideal für Spiegel-, Galerialeuchten und im Möbelbau
- ▶ Dimmbar mit allen Dimmern (Phasen- und -abschnitt)
- ▶ Dimension réduite des transformateurs plats Flattrafos à 24 mm
- ▶ Solution aux faux plafonds étroits
- ▶ Convient parfaitement aux luminaires pour miroirs, Galeria et ameublement
- ▶ Possibilité de variation crépusculaire avec tous les gradateurs (découpage début et fin de phase)
- ▶ Flattrafo's hebben een inbouwhoogte van slechts 24 mm
- ▶ Probleemoplossing voor verlaagde plafonds met te weinig tussenruimte
- ▶ Ideaal voor spiegelverlichting, Galerialampen en voor inbouw in meubels
- ▶ Dimbaar met alle dimmers (fase aan- en afsnijding)

**230/12V, 70 VA**

max. 20-70 W  
 ⚡24 ↔50 ↻147 mm  
 EAN 4000870 977811  
**977.81**

**230/12V, 105 VA**

max. 35-105 W  
 ⚡24 ↔50 ↻147 mm  
 EAN 4000870 977828  
**977.82**



## VDE Profi Transformer 230/12V

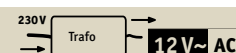

- ▶ Doppelter Primäranschluss für mehrere Trafos in einer Schaltung
- ▶ Mehrere Sekundärklemmpaare
- ▶ Bis 50 °C Umgebungstemperatur
- ▶ NYM-Kabel geeignet
- ▶ Unverlierbare Zugentlastung und Kappe
- ▶ Mittelauslass
- ▶ Dimmbar mit allen Dimmern (Phasen- und -abschnitt)
- ▶ Raccordement primaire double pour plusieurs transformateurs dans un circuit
- ▶ Plusieurs paires de bornes secondaires
- ▶ Supporte une température ambiante max. de 50 °
- ▶ À utiliser avec un câble NYM
- ▶ Décharge de traction et capuchon imperdables
- ▶ Source de courant centrale
- ▶ Possibilité de variation crépusculaire avec tous les gradateurs (découpage début et fin de phase)
- ▶ Dubbele primaire aansluiting voor meerdere trafo's in een schakeling
- ▶ Meerdere secundaire klemmen
- ▶ Tot een omgevingstemperatuur van 50 °
- ▶ Geschikt voor NYM-kabels
- ▶ Geborgde trekentlasting en kap
- ▶ Uitlaat in het midden
- ▶ Dimbaar met alle dimmers (fase aan- en afsnijding)

**230/12V, 105 VA**

max. 35-105 W  
 ⚡27 ↔39 ↻161 mm  
 EAN 4000870 977019  
**977.01**

**230/12V, 150 VA**

max. 50-150 W  
 ⚡40 ↔48 ↻190 mm  
 EAN 4000870 977156  
**977.15**

**230/12V, 250 VA**

max. 100-250 W  
 ⚡44 ↔51 ↻222 mm  
 EAN 4000870 977255  
**977.25**

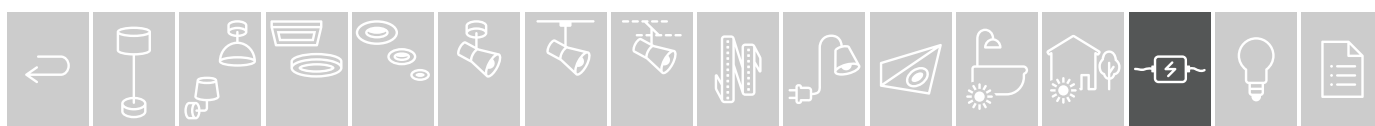

**Halo + LED Trafo 230/12V AC**

- |                                       |  |                                      |
|---------------------------------------|--|--------------------------------------|
| ▶ Für Halogen und LED                 | ▶ Pour halogène et LED                         | ▶ Voor halogeen en LED               |
| ▶ Keine Mindestlast                   | ▶ Aucune charge minimale                       | ▶ Geen minimumlast                   |
| ▶ Dimmbar mit Phasenabschnittsdimmern | ▶ Gradable avec gradateur à découpage de phase | ▶ Dimbaar met faseafsnijdingsdimmern |

**220-240/12V, 50 VA**

max. 0-50 W  
 ⌀28 ⇄44 ⇄127 mm  
 EAN 4000870 977620  
**977.62**

**220-240/12V, 65 VA**

max. 0-65 W  
 ⌀28 ⇄44 ⇄127 mm  
 EAN 4000870 977675  
**977.67**



LED 12V = 396-398

977.62 max. 30W

977.67 max. 40W



Halogen 12V = 435

977.62 max. 50W

977.67 max. 65W

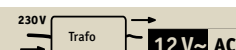
**Toroidal Decorative Transformer 230/12V****230/12V, 80 VA**

max. 80 W  
 ⌀86 ø145 mm  
 EAN 4000870 979327  
**979.32**

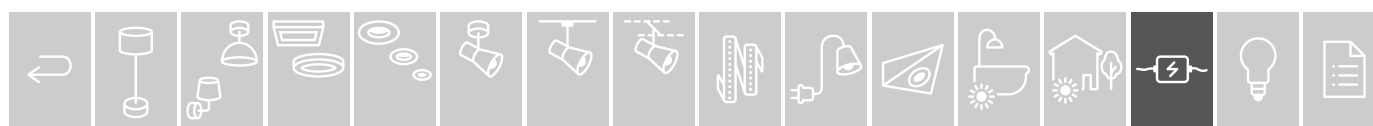

## Universal LED Power Supply 12W 12V DC



- ▶ Ersatz Netzteil für LED Stripes
- ▶ 1 Ampere
- ▶ < 0,5W Standby Verbrauch
- ▶ Inkl. Rundstecker - kann für Standard 12V LED Stripes verwendet werden
- ▶ Bloc d'alimentation de rechange pour Strips LED
- ▶ 1 ampère
- ▶ Consommation en veille < 0,5 W
- ▶ Fourni avec connecteur rond – peut être utilisé pour les Strips LED 12 V standard
- ▶ Vervangend netdeel voor LED-strips
- ▶ 1 ampère
- ▶ < 0,5 W standby verbruik
- ▶ Incl. Ronde connector - kan voor standaard 12 V LED-strips worden gebruikt

**230/12V, 12VA**

max. 12 W  
 ⌀63 ⇄40 ⌀26 mm  
 EAN 4000870 798324  
**798.32**

**230/12V, 36VA**

max. 36 W  
 ⌀101 ⇄51 ⌀31 mm  
 EAN 4000870 798348  
**798.34**



## Power Supply 60W 12V DC

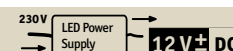

- ▶ Inkl. 1m Primär Zuleitung mit Eurostecker & 2m Sekundärleitung
- ▶ Inkl. Adapterstecker (Power Plug) von 5,5 mm Buchsen-Stecker für RGB
- ▶ Inkl. 4-Pin LED Stripe Adapter - kann für 12V LED Stripes verwendet werden
- ▶ < 0,5W Standby Verbrauch
- ▶ Avec câble primaire 1 m avec connecteur euro & câble secondaire 2 m
- ▶ Fourni avec l'adaptateur (Power Plug) du connecteur femelle de 5,5 mm pour RGB
- ▶ Fourni avec adaptateur pour Strips LED 4 broches – peut être utilisé pour les Strips LED 12 V
- ▶ Consommation en veille < 0,5 W
- ▶ Incl. primaire toevoer van 1 m met eurostekker & secundaire toevoer van 2 m
- ▶ Incl. adapterstekker (Power Plug) van 5,5 mm bus-stekker voor RGB
- ▶ Incl. adapter voor 4-pin LED-strips - kan voor standaard 12 V LED-strips worden gebruikt
- ▶ < 0,5 W standby verbruik

**230/12V, 60VA**

max. 60 W  
 ⌀35 ⇄60 ⌀130 mm  
 EAN 4000870 977637  
**977.63**

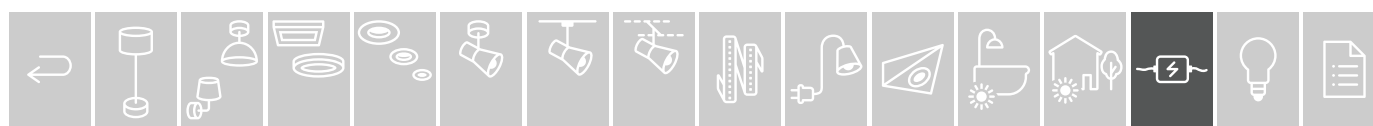



## LED-Driver Disc 350mA 10W max. 35V DC



- ▶ Driver sind speziell für den LED-Betrieb konzipiert
- ▶ 350 mA Konstantstrom
- ▶ Pilotes sont spécialement conçus pour le fonctionnement LED
- ▶ Courant constant 350 mA
- ▶ Drivers zijn speciaal ontworpen voor LED-bedrijf
- ▶ 350 mA constante stroom

**230V, 10VA**

max. 5,5-10 W  
 ⌀24 ⌀52 mm  
 EAN 4000870 977385  
**977.38**

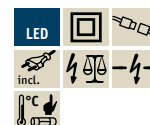

## PIR-Sensor 230V

- ▶ Näherungsschalter für die An-/Aus-Schaltung von LED-Strips und weiterer Produkte
- ▶ Max. 75 W (magnetische Trafos)
- ▶ Max. 60 W (elektronische Last)
- ▶ Max. 250 W (Glühlampen)
- ▶ Zum Anschluss an 230V Kabel
- ▶ Interrupteur de proximité Marche/Arrêt des rubans LED et autres produits
- ▶ Max. 75 W (transformateurs magnétiques)
- ▶ Max. 60 W (charge électronique)
- ▶ Max. 250 W (ampoules à incandescence)
- ▶ Câble de raccordement au réseau 230 V
- ▶ Naderingsschakelaar voor het in-/uitschakelen van de LED-stripes en andere producten
- ▶ Max. 75 W (magnetische trafo's)
- ▶ Max. 60 W (elektronische last)
- ▶ Max. 250 W (gloeilampen)
- ▶ Voor aansluiting op 230 V kabel

**230V**

max. 60 W  
 ⌀19 ⌀17,5 ⇄85 ↗36 mm  
 EAN 4000870 704516  
**704.51**

(mm)

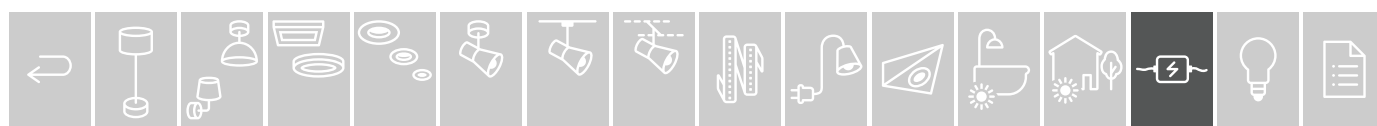
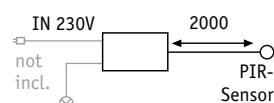
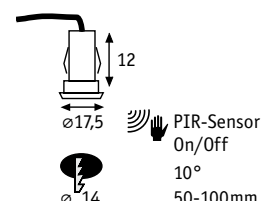

# Lamps

- 397 LED Standard 12V
- 399 LED Standard 230V
- 405 LED Standard Filament 230V
- 412 LED Decorative
- 430 LED Smart Home
- 433 Energy Saver / Tube fluorescent
- 435 Halogen 12V
- 435 Halogen 230V
- 436 Conventional Lamps



DE Goldglaslampen mit graviertem Leuchtzylinder  
 FR Ampoules en verre doré avec cylindre lumineux gravé  
 NL Goudkleurige glazen lampen met gegraveerde lampcilinder

- ▶ 1800 K extra warm white



DE Edle Goldglaslampen  
 FR Ampoules en verre doré élégant  
 NL Edele goudkleurige glazen lampen

- ▶ 2500–2700 K warm white

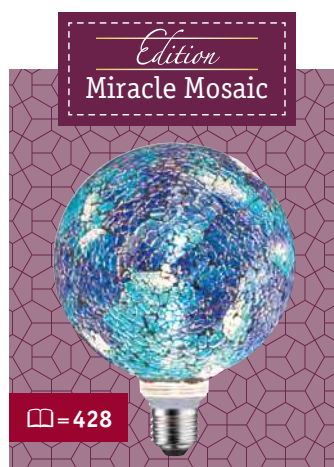

DE Vollglaslampen mit Glasmosaik  
 FR Ampoules en verre plein avec mosaïque de verre  
 NL Glaslampen met glasmozaïek

- ▶ 2700 K warm white
- ▶ Dimmable



DE Dekorative GU5,3 und GU10 Reflektoren- und Filamentlampen in vielen Farben  
 FR Réflecteurs GU5,3 et GU10 décoratifs et ampoules à filament dans de nombreuses couleurs  
 NL Decoratieve GU5,3- en GU10-reflector- en filamentlampen in vele kleuren

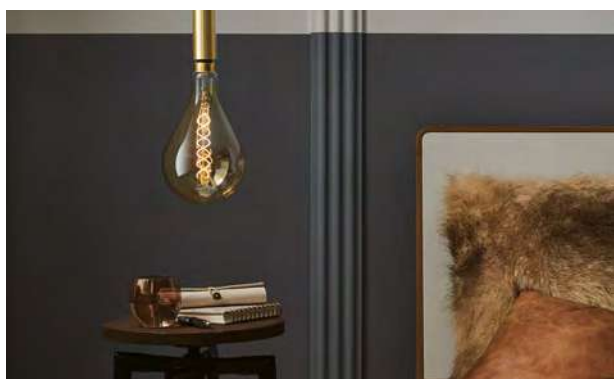

1879 Edition



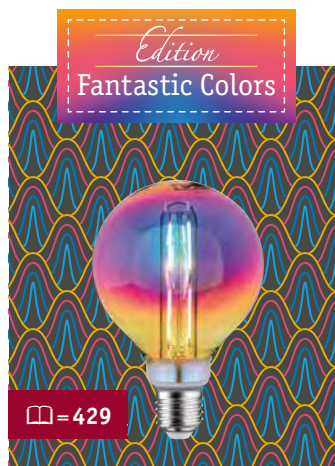

*Edition*  
Fantastic Colors

☞ = 429

DE Spezialeffekt-Glas mit zauberhaftem Regenbogeneffekt  
FR Verre à effet spécial avec un merveilleux effet arc-en-ciel  
NL Speciaal glas met betoverend regenboogeffect

- ▶ 2700 K warm white
- ▶ Dimmable

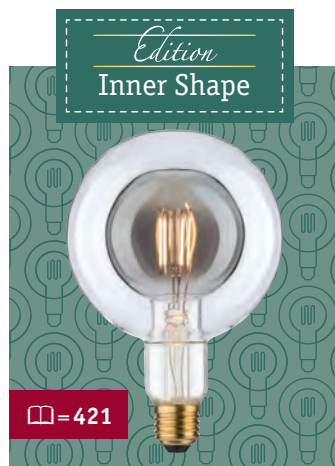

*Edition*  
Inner Shape

☞ = 421

DE Klarglas umhüllt Dekorglas  
FR Verre décoratif recouvert de verre clair  
NL Helder glas omhult decoratief glas

- ▶ 2700 K warm white
- ▶ Dimmable

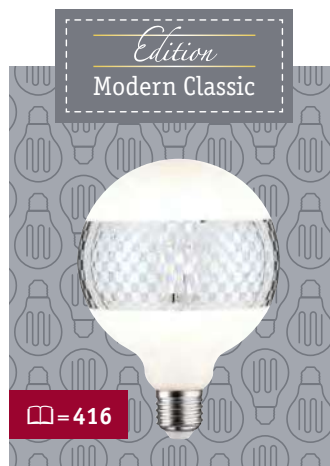

*Edition*  
Modern Classic

☞ = 416

DE Kopf- und Ringverspiegelte Lampen  
FR Ampoules à calotte et anneau réfléchissants  
NL Kop- en ringspiegellampen

- ▶ 2500–2700 K warme white



*Edition*  
Grow Green

☞ = 432

DE Spezielles Farbspektrum für das Wachstum von Pflanzen im Innenbereich  
FR Spectre de couleur spécial pour la croissance des plantes d'intérieur

NL Speciaal kleurenspectrum voor de groei van planten binnenshuis

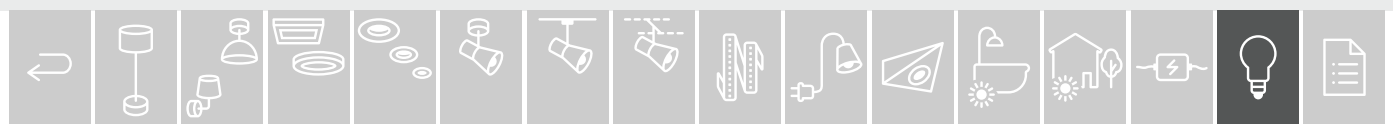



## Finde die richtige Lampe







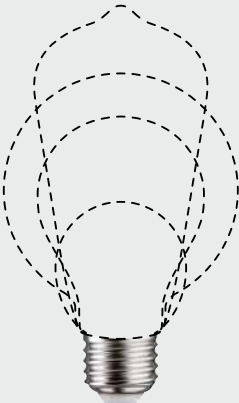

Socket-Übersicht: die passende Lampe für deine Leuchte

## Trouvez l'ampoule adéquate

Aperçu des culots : l'ampoule adaptée à votre luminaire

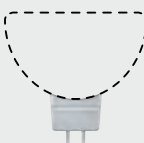
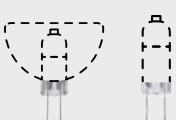
## Vind de juiste lamp

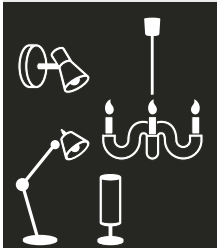
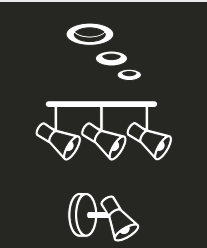
Overzicht fittingen: de juiste lamp voor jouw armatuur

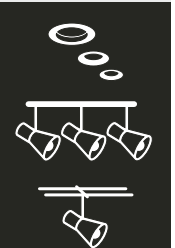
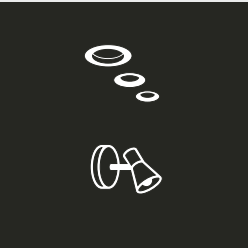
230V				12V	
					
<b>E27</b>	<b>E14</b>	<b>GU10</b>	<b>G9</b>	<b>GU5,3</b>	<b>GU4/G4 GY6,35</b>
					



Lichtfarben als Stimmungsmacher

Températures de couleur pour créer une ambiance

Lichtkleuren als sfeermake



☰ = 441

● extra warm white  
1500–2700 K

● warm white  
2700–3300 K

○ neutral white  
3300–5300 K

● daylight  
≥ 5300 K

So kannst du die Helligkeit ganz einfach vergleichen

Vous pouvez donc facilement comparer la luminosité

Zo kunt u de helderheid gemakkelijk vergelijken

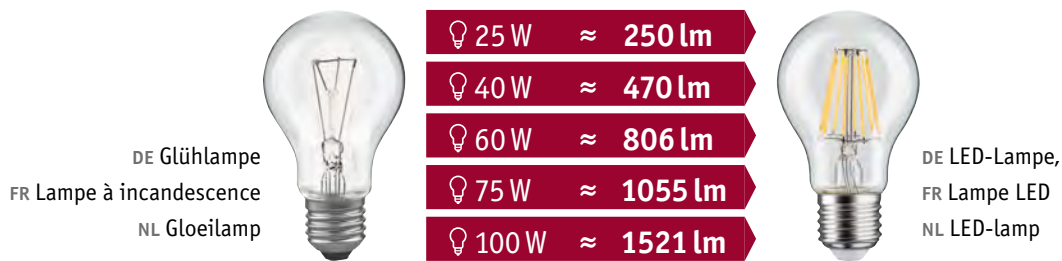

Wusstest du, dass LED-Lampen ...

Mindestens 80% weniger Energie als herkömmliche Glühlampen verbrauchen, mindestens 10-mal so lange halten, sofort hell werden und von warmen bis kühlen Weißtönen sowie RGB-Farbwahl fast alle gewünschten Lichtfarben erzeugen können?

Saviez-vous que les lampes LED ...

Utilisent au moins 80% d'énergie en moins que les lampes à incandescence conventionnelles, durent au moins 10 fois plus longtemps, deviennent immédiatement brillantes et peuvent produire presque toutes les couleurs de lumière souhaitées, des blancs chauds aux blancs froids et à la sélection de couleurs RGB ?

Wist u dat LED-lampen ...

Minstens 80% minder energie verbruiken dan conventionele gloeilampen, minstens 10 keer langer meegaan, onmiddellijk helder worden en bijna elke gewenste lichtkleur kunnen produceren van warme tot koele witte tinten en RGB-kleureselectie?

DE Leistungsaufnahme (Watt)  
FR Consommation électrique (Watt)  
NL Energieverbruik (Watt)

DE Sockel  
FR Culots  
NL Fitting

DE Lichtfarbe  
FR Couleur de la lumière  
NL Licht van kleur

DE Helligkeit  
FR Luminosité  
NL Helderheid



☰ = 440

DE Vergleichswattage  
FR Comparaison des puissances  
NL Vergelijking wattage







## LED Standard 12V

Wei Blanc Wit



	W	⊖	∅ mm	⇅ mm	lm	✂	K	⌚	EAN	✓	
<b>A F</b>	2,5	G4	22	33	250		2.700	15.000	4000870 288115	✓	<b>288.11</b>
	3,5 VA										



	W	⊖	∅ mm	⇅ mm	lm	✂	K	⌚	EAN	✓	
<b>A G</b>	3,2	G4	30	41	270		2.700	15.000	4000870 287750	✓	<b>287.75</b>
	3,2 VA										

Klar Clair Helder



	W	⊖	∅ mm	⇅ mm	lm	✂	K	⌚	EAN	✓	
<b>A F</b>	3	G4	17	47	300		4.000	15.000	4000870 288184	✓	<b>288.18</b>
	4,2 VA										

Klar Clair Helder



	W	⊖	∅ mm	⇅ mm	lm	✂	K	⌚	EAN	✓	
<b>A F</b>	3	G4	17	47	300		2.700	15.000	4000870 288139	✓	<b>288.13</b>
	4,2 VA										
<b>A F</b>	3x3	G4	17	47	300		2.700	15.000	4000870 288146	✓	<b>288.14</b>
	4,2 VA										

Klar Clair Helder



	W	⊖	∅ mm	⇅ mm	lm	✂	K	⌚	EAN	✓	
<b>A G</b>	4	G4	16	55	350		2.700	15.000	4000870 288252	✓	<b>new 288.25</b>
	5,5 VA										

Klar Clair Helder



 **dimmable**

	W	⊖	∅ mm	⇅ mm	lm	✂	K	⌚	EAN	✓	
<b>A F</b>	4	GY6,35	18	50	400		2.700	25.000	4000870 288337	✓	<b>new 288.33</b>
	R, C										

Klar Clair Helder



	W	⊖	∅ mm	⇅ mm	lm	✂	K	⌚	EAN	✓	
<b>A G</b>	3,5	GY6,35	17	47	300		2.700	15.000	4000870 288214	✓	<b>288.21</b>
	4,5 VA										
<b>A G</b>	3x3,5	GY6,35	17	47	300		2.700	15.000	4000870 288221	✓	<b>288.22</b>
	4,5 VA										

Klar Clair Helder



	W	⊖	∅ mm	⇅ mm	lm	✂	K	⌚	EAN	✓	
<b>A F</b>	3	GY6,35	17	47	300		4.000	15.000	4000870 288245	✓	<b>288.24</b>
	4,2 VA										

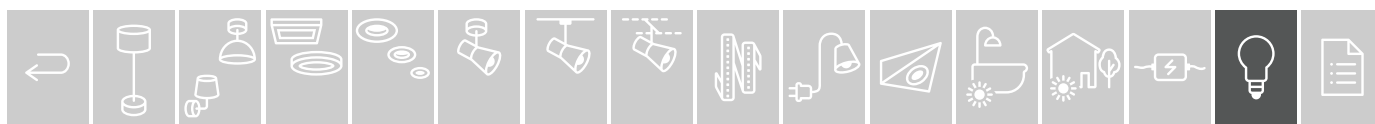



☞ Schwarz matt Noir mat Zwart mat



dimmable

	W	⊖	∅ mm	↑ mm	lm	↘	K	⌚	EAN	✓	
<b>A G</b>	<b>6,5</b>	GU5,3	50	48	445	36	2.700	15.000	4000870 287576	✓	<b>287.57</b>
	6,6 VA										
<b>A G</b>	<b>6,5</b>	GU5,3	50	48	445	38	4.000	15.000	4000870 288726	✓	<b>new 288.72</b>
	7 VA										

☞ Weiß matt Blanc dépoli Wit mat



dimmable

	W	⊖	∅ mm	↑ mm	lm	↘	K	⌚	EAN	✓	
<b>A G</b>	<b>6,5</b>	GU5,3	50	48	445	36	2.700	15.000	4000870 287583	✓	<b>287.58</b>
	6,6 VA										
<b>A G</b>	<b>6,5</b>	GU5,3	50	48	445	38	4.000	15.000	4000870 288733	✓	<b>new 288.73</b>
	7 VA										

☞ Chrom matt Chrome mat Chroom mat



dimmable

	W	⊖	∅ mm	↑ mm	lm	↘	K	⌚	EAN	✓	
<b>A G</b>	<b>6,5</b>	GU5,3	50	48	445	36	2.700	15.000	4000870 287590	✓	<b>287.59</b>
	6,6 VA										
<b>A G</b>	<b>6,5</b>	GU5,3	50	48	445	38	4.000	15.000	4000870 288740	✓	<b>new 288.74</b>
	7 VA										

**Maxiflood**

Strahlt gleichmäßig rundum in alle Richtungen (ideal für farbige Lampenschirme)

**Maxiflood**

Rayonne uniformément dans toutes les directions (idéal pour les abat-jour de couleur)

**Maxiflood**

Straalt gelijkmatig rondom in alle richtingen (optimaal voor gekleurde lampenschermen)

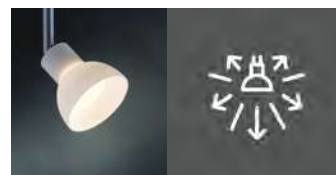

☞ Softopal Soft-opale Softopaal



	W	⊖	∅ mm	↑ mm	lm	↘	K	⌚	EAN	✓	
<b>A G</b>	<b>1,8</b>	GU4	35	33	100		2.700	15.000	4000870 283295	✓	<b>283.29</b>
	2 VA										



Maxiflood

	W	⊖	∅ mm	↑ mm	lm	↘	K	⌚	EAN	✓	
<b>A G</b>	<b>3</b>	GU5,3	51	45	220		2.700	15.000	4000870 283301	✓	<b>283.30</b>
	4 VA										

**Juwel**

Nach vorn strahlt brillantes Licht, nach hinten satinfarben schimmernde Reflexionen.

**Juwel**

Diffusion d'une lumière brillante à l'avant et reflets scintillants aux couleurs satinées à l'arrière

**Juwel**

Naar voren schijnt helder licht, naar achteren worden glinsterende reflecties in satijnkleur gevormd.



☞ Silber Argent Zilver



Juwel

	W	⊖	∅ mm	↑ mm	lm	↘	K	⌚	EAN	✓	
<b>A G</b>	<b>3</b>	GU5,3	50	48	230	38	2.700	15.000	4000870 289105	✓	<b>new 289.10</b>
	4 VA										

☞ Alu Alu Alu



AR 111

	W	⊖	∅ mm	↑ mm	lm	↘	K	⌚	EAN	✓	
<b>A G</b>	<b>8</b>	G53	111	56	500	24	2.700	15.000	4000870 285152	✓	<b>285.15</b>
	10,5 VA										

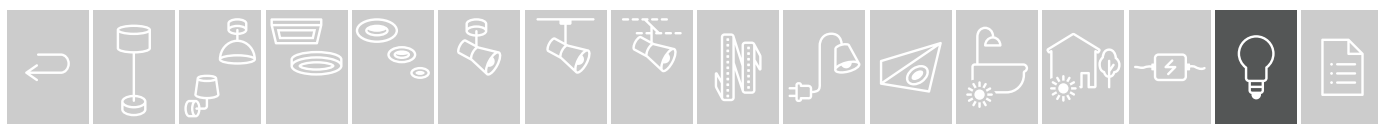







3 step dim

Klar Clair Helder

ATG	W	⊖	∅ mm	⇅ mm	lm	✂	K	⌚	EAN	✓	Price
F	4	G9	18	55	350		2.700	15.000	4000870 287965		287.96

3 step dim



dim to warm

Klar Clair Helder

ATG	W	⊖	∅ mm	⇅ mm	lm	✂	K	⌚	EAN	✓	Price
G	4	G9	18	55	270		2.000 - 3.000	15.000	4000870 288191		288.19



tunable white

Klar Clair Helder

ATG	W	⊖	∅ mm	⇅ mm	lm	✂	K	⌚	EAN	✓	Price
G	4	G9	18	55	300		2.200 - 6.500	15.000	4000870 288207		288.20



Klar Clair Helder

ATG	W	⊖	∅ mm	⇅ mm	lm	✂	K	⌚	EAN	✓	Price
F	5	G9	18	70	470		4.000	15.000	4000870 287996		287.99

ATG	W	⊖	∅ mm	⇅ mm	lm	✂	K	⌚	EAN	✓	Price
F	3x5	G9	18	70	470		4.000	15.000	4000870 288016		288.01



dimmable

ATG	W	⊖	∅ mm	⇅ mm	lm	✂	K	⌚	EAN	✓	Price
F	5	G9	18	70	470		4.000	15.000	4000870 288009		288.00



dimmable

Klar Clair Helder

ATG	W	⊖	∅ mm	⇅ mm	lm	✂	K	⌚	EAN	✓	Price
F	6	G9	18	70	550		2.700	15.000	4000870 288061		288.06



Klar Clair Helder

ATG	W	⊖	∅ mm	⇅ mm	lm	✂	K	⌚	EAN	✓	Price
F	2,5	G9	18	66	250		2.700	15.000	4000870 288092		new 288.09

ATG	W	⊖	∅ mm	⇅ mm	lm	✂	K	⌚	EAN	✓	Price
F	3x2,5	G9	18	66	250		2.700	15.000	4000870 288108		new 288.10



Klar Clair Helder

ATG	W	⊖	∅ mm	⇅ mm	lm	✂	K	⌚	EAN	✓	Price
E	4,5	G9	18	76	550		2.700	15.000	4000870 288344		new 288.34



Klar Clair Helder

ATG	W	⊖	∅ mm	⇅ mm	lm	✂	K	⌚	EAN	✓	Price
F	2,5	G9	17	50	250		2.700	15.000	4000870 288078		new 288.07

ATG	W	⊖	∅ mm	⇅ mm	lm	✂	K	⌚	EAN	✓	Price
F	3x2,5	G9	17	50	250		2.700	15.000	4000870 288085		new 288.08

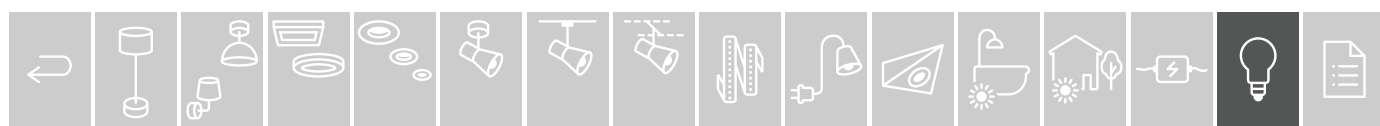

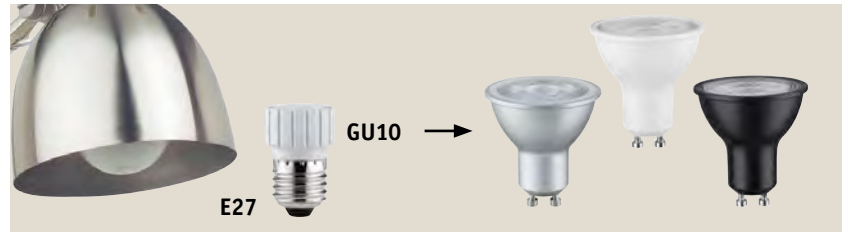

Wei Blanc Wit

W	⊖	∅ mm	⇅ mm	lm	⚡	K	⌚	EAN	Ⓜ	
max. 50	GU10 / E27	35	53					4000870 549292	✓	549.29



Schwarz matt Noir mat Zwart mat



dimmmable

W	⊖	∅ mm	⇅ mm	lm	⚡	K	⌚	EAN	Ⓜ	
7	GU10	51	54	460	36	2.700	15.000	4000870 287514	✓	287.51
7	GU10	51	54	460	36	4.000	15.000	4000870 287545	✓	287.54

Wei matt Blanc d poli Wit mat



dimmmable

W	⊖	∅ mm	⇅ mm	lm	⚡	K	⌚	EAN	Ⓜ	
7	GU10	51	54	460	36	2.700	15.000	4000870 287521	✓	287.52
7	GU10	51	54	460	36	4.000	15.000	4000870 287552	✓	287.55

Chrom matt Chrome mat Chroom mat



dimmmable

W	⊖	∅ mm	⇅ mm	lm	⚡	K	⌚	EAN	Ⓜ	
7	GU10	51	54	460	36	2.700	15.000	4000870 287538	✓	287.53
7	GU10	51	54	460	36	4.000	15.000	4000870 287569	✓	287.56

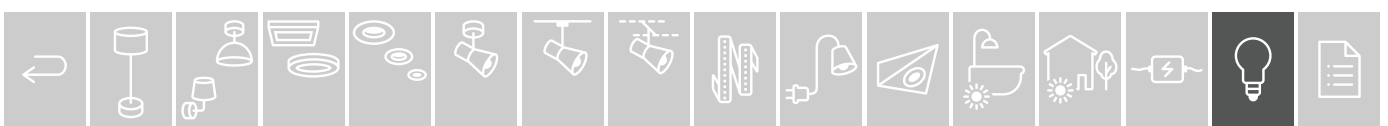



Wei Blanc Wit

W	⊖	∅ mm	⇅ mm	lm	⚡	K	⌚	EAN	✓	Price
<b>6</b>	GU10	50	54	350	36	1.800 - 3.000	15.000	4000870 287354	✓	<b>287.35</b>



Wei Blanc Wit

W	⊖	∅ mm	⇅ mm	lm	⚡	K	⌚	EAN	✓	Price
<b>6,5</b>	GU10	51	56	460	38	2.700	15.000	4000870 285770	✓	<b>285.77</b>



Wei Blanc Wit

W	⊖	∅ mm	⇅ mm	lm	⚡	K	⌚	EAN	✓	Price
<b>5,9</b>	GU10	50	56	470	110	2.700 - 6.500	15.000	4000870 287972	✓	<b>287.97</b>



Wei Blanc Wit

W	⊖	∅ mm	⇅ mm	lm	⚡	K	⌚	EAN	✓	Price
<b>5,5</b>	GU10	50	56	460	110	2.700	15.000	4000870 287989	✓	<b>287.98</b>



Alu Alu Alu

W	⊖	∅ mm	⇅ mm	lm	⚡	K	⌚	EAN	✓	Price
<b>3x4</b>	GU10	51	55	230	36	2.700	15.000	4000870 285817	✓	<b>285.81</b>

W	⊖	∅ mm	⇅ mm	lm	⚡	K	⌚	EAN	✓	Price
<b>3x6,5</b>	GU10	51	54	425	38	2.700	15.000	4000870 284308	✓	<b>284.30</b>



QPAR 111

Alu Alu Alu

W	⊖	∅ mm	⇅ mm	lm	⚡	K	⌚	EAN	✓	Price
<b>4</b>	GU10	111	70	350	24	2.700	15.000	4000870 285145	✓	<b>285.14</b>



Silber Argent Zilver

W	⊖	∅ mm	⇅ mm	lm	⚡	K	⌚	EAN	✓	Price
<b>13,8</b>	E27	122	134	1.000	30	3.000	25.000	4000870 288269	✓	<b>new 288.26</b>





Klar Clair Helder

	W	⊖	∅ mm	⇅ mm	lm	↗	K	⊕	EAN	✓	new
<b>A7E</b>	9	R7s	28	78	1.055		2.700	15.000	4000870 288382	✓	288.38

	W	⊖	∅ mm	⇅ mm	lm	↗	K	⊕	EAN	✓	new
<b>A7E</b>	12	R7s	28	118	1.521		2.700	15.000	4000870 288375	✓	288.37

Klar Clair Helder

	W	⊖	∅ mm	⇅ mm	lm	↗	K	⊕	EAN	✓	new
<b>A7E</b>	9	R7s	28	78	1.055		2.700	15.000	4000870 288368	✓	288.36



dimmable

	W	⊖	∅ mm	⇅ mm	lm	↗	K	⊕	EAN	✓	new
<b>A7E</b>	13	R7s	28	118	1.521		2.700	15.000	4000870 288351	✓	288.35



dimmable



Klar Clair Helder

	W	⊖	∅ mm	⇅ mm	lm	↗	K	⊕	EAN	✓	new
	1	E14	21	60	50		3.000	30.000	4000870 281109	✓	281.10
	1	E14	21	60	50		6.500	30.000	4000870 281116	✓	281.11



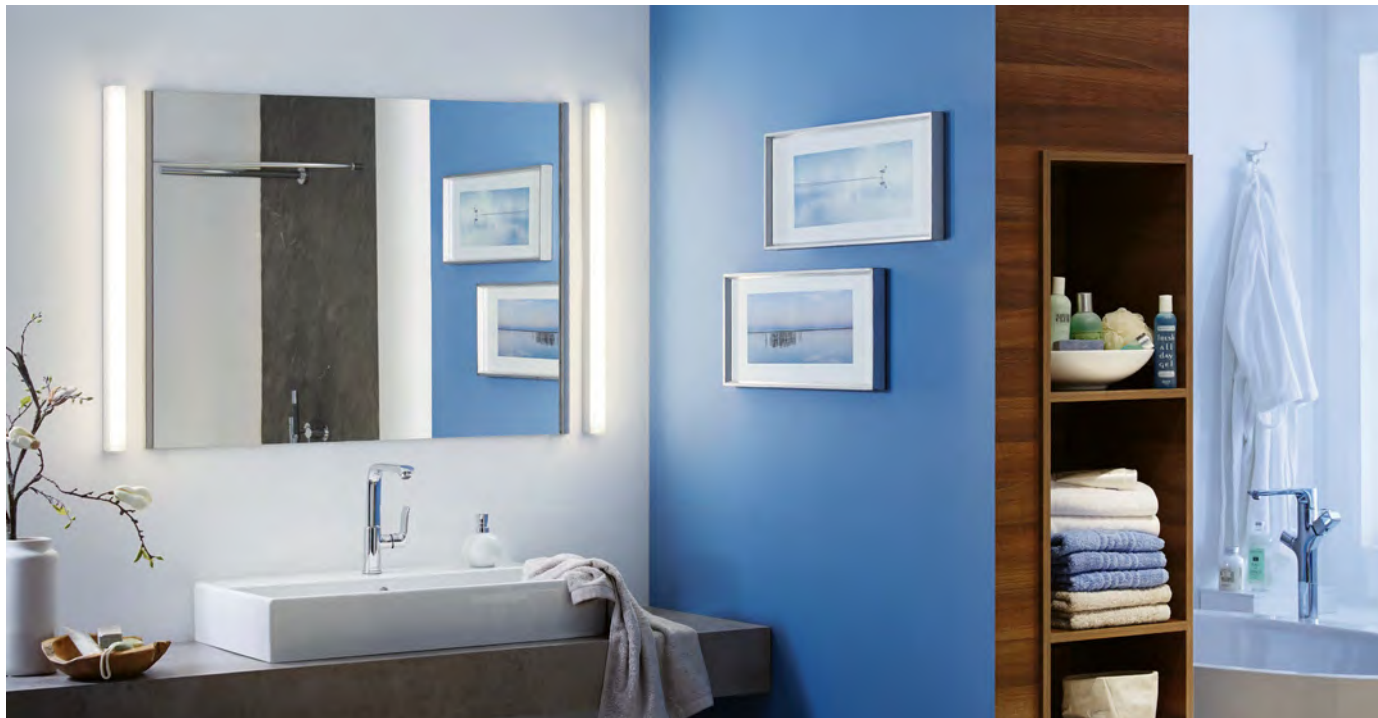

► Nur für Konventionelle  
Vorschaltgeräte

► Uniquement pour  
Ballasts traditionnels

► Alleen voor conventionele  
voorschakelapparaten



Opal Opale Opaal

	W	⊖	∅ mm	⇅ mm	lm	✂	K	⌚	EAN	📦
<b>ATG F</b>	9,5	G13	28	604	850		4.000	15.000	4000870 289020	<b>new 289.02</b>

incl.

	W	⊖	∅ mm	⇅ mm	lm	✂	K	⌚	EAN	📦
<b>ATG F</b>	18	G13	28	1.214	1.800		4.000	15.000	4000870 289037	<b>new 289.03</b>



T8

	W	⊖	∅ mm	⇅ mm	lm	✂	K	⌚	EAN	📦
<b>ATG F</b>	22,5	G13	28	1.514	2.200		4.000	15.000	4000870 289044	<b>new 289.04</b>

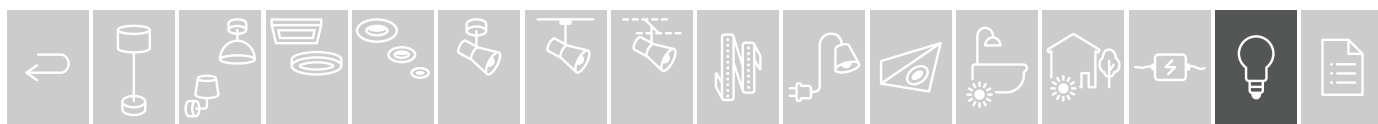







## LED Standard Filament 230 V

## Klar Clair Helder



	W	⚡	∅ mm	⇅ mm	lm	♀	K	⌚	EAN	✓	
 <b>F</b>	2,6	E14	35	98	250		2.700	15.000	4000870 286838	✓	<b>286.83</b>
 <b>F</b>	4,5	E14	35	98	470		2.700	15.000	4000870 286111	✓	<b>286.11</b>
 <b>E</b>	6,5	E14	35	97	806		2.700	20.000	4000870 286432	✓	<b>286.43</b>
	W	⚡	∅ mm	⇅ mm	lm	♀	K	⌚	EAN	✓	
 <b>F</b>	2x2,7	E14	35	97	250		2.700	15.000	4000870 288559	✓	<b>new 288.55</b>
 <b>F</b>	2x4,5	E14	35	98	470		2.700	15.000	4000870 287880	✓	<b>287.88</b>

## Klar Clair Helder



  
dimmable

	W	⚡	∅ mm	⇅ mm	lm	♀	K	⌚	EAN	✓	
 <b>F</b>	4,8	E14	35	98	470		2.700	15.000	4000870 286845	✓	<b>286.84</b>



  
3 step touch dim

	W	⚡	∅ mm	⇅ mm	lm	♀	K	⌚	EAN	✓	
 <b>F</b>	5	E14	35	80	432		2.700	15.000	4000870 287385	✓	<b>287.38</b>



  
3 step dim

	W	⚡	∅ mm	⇅ mm	lm	♀	K	⌚	EAN	✓	
 <b>F</b>	2,7	E14	35	97	250		2.700	15.000	4000870 285725	✓	<b>285.72</b>



  
dim to warm

	W	⚡	∅ mm	⇅ mm	lm	♀	K	⌚	EAN	✓	
 <b>F</b>	5	E14	35	117	470		1.800 - 3.000	15.000	4000870 287774	✓	<b>287.77</b>

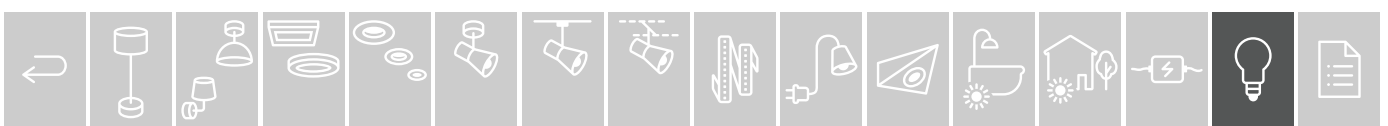



Matt Dépoli Mat

	W	⊖	∅ mm	⇅ mm	lm	✂	K	⊕	EAN	☑	
<b>A</b> <b>G</b>	3	E14	35	98	250		2.700	15.000	4000870 286104	✓	<b>286.10</b>
<b>A</b> <b>F</b>	4,5	E14	35	98	470		2.700	15.000	4000870 286128	✓	<b>286.12</b>
<b>A</b> <b>E</b>	6,5	E14	35	98	806		2.700	15.000	4000870 286456	✓	<b>286.45</b>



	W	⊖	∅ mm	⇅ mm	lm	✂	K	⊕	EAN	☑	
<b>A</b> <b>G</b>	2x3	E14	35	98	250		2.700	15.000	4000870 286364	✓	<b>286.36</b>
<b>A</b> <b>F</b>	2x5	E14	35	98	470		2.700	15.000	4000870 286371	✓	<b>286.37</b>



dimmable

	W	⊖	∅ mm	⇅ mm	lm	✂	K	⊕	EAN	☑	
<b>A</b> <b>F</b>	5	E14	35	98	470		2.700	15.000	4000870 286135	✓	<b>286.13</b>



Klar Clair Helder

dimmable

	W	⊖	∅ mm	⇅ mm	lm	✂	K	⊕	EAN	☑	
<b>A</b> <b>F</b>	2,8	E14	35	120	250		2.700	15.000	4000870 286869	✓	<b>286.86</b>
<b>A</b> <b>F</b>	4,8	E14	35	120	470		2.700	15.000	4000870 286876	✓	<b>286.87</b>



Satin Satiné Satijn

dimmable

	W	⊖	∅ mm	⇅ mm	lm	✂	K	⊕	EAN	☑	
<b>A</b> <b>F</b>	2,6	E14	35	120	250		2.700	15.000	4000870 286852	✓	<b>286.85</b>

	W	⊖	∅ mm	⇅ mm	lm	✂	K	⊕	EAN	☑	
<b>A</b> <b>F</b>	4,8	E14	35	120	470		2.700	15.000	4000870 286883	✓	<b>286.88</b>



dimmable

Matt/Weiß Dépoli/Blanc Mat/Wit

	W	⊖	∅ mm	⇅ mm	lm	✂	K	⊕	EAN	☑	
<b>A</b> <b>F</b>	5	E14	35	98	470		4.000	15.000	4000870 287279	✓	<b>287.27</b>



dimmable

Matt Dépoli Mat

	W	⊖	∅ mm	⇅ mm	lm	✂	K	⊕	EAN	☑	
<b>A</b> <b>F</b>	5	E14	35	98	470		6.500	15.000	4000870 287606	✓	<b>287.60</b>

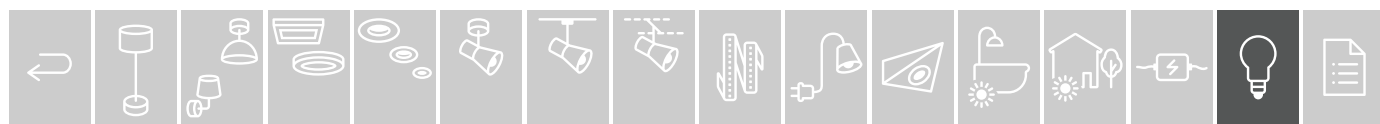



## Klar Clair Helder



	W	⊖	∅ mm	⇅ mm	lm	✂	K	⌚	EAN	✓	
<b>A T G</b> F	2,6	E14	45	78	250		2.700	15.000	4000870 286890	✓	286.89
<b>A T G</b> F	5	E14	45	78	470		2.700	15.000	4000870 286302	✓	286.30
<b>A T G</b> E	6,5	E14	45	85	806		2.700	20.000	4000870 286500	✓	286.50



	W	⊖	∅ mm	⇅ mm	lm	✂	K	⌚	EAN	✓	
<b>A T G</b> F	2x2,7	E14	45	81	250		2.700	15.000	4000870 288573	✓	new 288.57

## Klar Clair Helder



dimmable

	W	⊖	∅ mm	⇅ mm	lm	✂	K	⌚	EAN	✓	
<b>A T G</b> F	4,8	E14	45	78	470		2.700	15.000	4000870 286906	✓	286.90

R, C



3 step touch dim

	W	⊖	∅ mm	⇅ mm	lm	✂	K	⌚	EAN	✓	
<b>A T G</b> F	5	E14	45	97	432		2.700	15.000	4000870 287392	✓	287.39

3 step touch dim



3 step dim

	W	⊖	∅ mm	⇅ mm	lm	✂	K	⌚	EAN	✓	
<b>A T G</b> F	2,7	E14	45	80	250		2.700	15.000	4000870 285732	✓	285.73

3 step dim



dim to warm

	W	⊖	∅ mm	⇅ mm	lm	✂	K	⌚	EAN	✓	
<b>A T G</b> F	5	E14	45	99	470		1.800 - 3.000	15.000	4000870 287781	✓	287.78

R, L, C

## Klar Clair Helder



	W	⊖	∅ mm	⇅ mm	lm	✂	K	⌚	EAN	✓	
<b>A T G</b> F	2,6	E27	45	72	250		2.700	15.000	4000870 286913	✓	286.91
<b>A T G</b> F	5	E27	45	72	470		2.700	15.000	4000870 286333	✓	286.33
<b>A T G</b> E	6,5	E27	45	78	806		2.700	20.000	4000870 286548	✓	286.54



	W	⊖	∅ mm	⇅ mm	lm	✂	K	⌚	EAN	✓	
<b>A T G</b> F	2x5	E27	45	72	470		2.700	15.000	4000870 286401	✓	286.40



dimmable

	W	⊖	∅ mm	⇅ mm	lm	✂	K	⌚	EAN	✓	
<b>A T G</b> F	4,8	E27	45	72	470		2.700	15.000	4000870 286920	✓	286.92
<b>A T G</b> E	6,5	E27	45	78	800		2.700	20.000	4000870 286555	✓	286.55

R, C



Matt Dépoli Mat



	W	⊖	∅ mm	⇅ mm	lm	✂	K	⊕	EAN	✓	
<b>A G</b> <b>G</b>	3	E14	45	78	250		2.700	15.000	4000870 286296	✓	<b>286.29</b>
<b>A G</b> <b>F</b>	5	E14	45	78	470		2.700	15.000	4000870 286319	✓	<b>286.31</b>
<b>A G</b> <b>E</b>	6,5	E14	45	80	806		2.700	15.000	4000870 286524	✓	<b>286.52</b>



	W	⊖	∅ mm	⇅ mm	lm	✂	K	⊕	EAN	✓	
<b>A G</b> <b>G</b>	2x3	E14	45	78	250		2.700	15.000	4000870 286388	✓	<b>286.38</b>
<b>A G</b> <b>F</b>	2x4,5	E14	45	78	470		2.700	15.000	4000870 287897	✓	<b>287.89</b>



dimmable

	W	⊖	∅ mm	⇅ mm	lm	✂	K	⊕	EAN	✓	
<b>A G</b> <b>F</b>	5	E14	45	78	470		2.700	15.000	4000870 286326	✓	<b>286.32</b>



dimmable

Matt Dépoli Mat

	W	⊖	∅ mm	⇅ mm	lm	✂	K	⊕	EAN	✓	
<b>A G</b> <b>F</b>	5	E14	45	78	470		4.000	15.000	4000870 287286	✓	<b>287.28</b>



dimmable

Matt Dépoli Mat

	W	⊖	∅ mm	⇅ mm	lm	✂	K	⊕	EAN	✓	
<b>A G</b> <b>F</b>	5	E14	45	78	470		6.500	15.000	4000870 287613	✓	<b>287.61</b>



Matt Dépoli Mat

	W	⊖	∅ mm	⇅ mm	lm	✂	K	⊕	EAN	✓	
<b>A G</b> <b>F</b>	5	E27	45	75	470		2.700	15.000	4000870 286340	✓	<b>286.34</b>
<b>A G</b> <b>E</b>	6,5	E27	45	85	806		2.700	15.000	4000870 286562	✓	<b>286.56</b>



	W	⊖	∅ mm	⇅ mm	lm	✂	K	⊕	EAN	✓	
<b>A G</b> <b>F</b>	2x5	E27	45	78	470		2.700	15.000	4000870 286395	✓	<b>286.39</b>



dimmable

	W	⊖	∅ mm	⇅ mm	lm	✂	K	⊕	EAN	✓	
<b>A G</b> <b>F</b>	5	E27	45	72	470		2.700	15.000	4000870 286357	✓	<b>286.35</b>
<b>A G</b> <b>E</b>	6,5	E27	45	78	800		2.700	20.000	4000870 286579	✓	<b>286.57</b>



dimmable

Klar Clair Helder

	W	⊖	∅ mm	⇅ mm	lm	✂	K	⊕	EAN	✓	
<b>A G</b> <b>F</b>	2,8	E14	25	82	250		2.700	15.000	4000870 286944	✓	<b>286.94</b>
<b>A G</b> <b>F</b>	4,8	E14	25	82	470		2.700	15.000	4000870 286937	✓	<b>286.93</b>

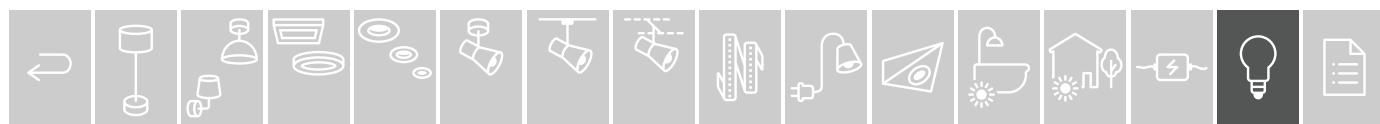

## Klar Clair Helder



	W	⊖	∅ mm	⇅ mm	lm	♀	K	⌚	EAN	✓	
<b>A T G</b> <b>G</b>	3	E27	60	106	250		2.700	15.000	4000870 286142	✓	<b>286.14</b>
<b>A T G</b> <b>F</b>	4,3	E27	60	106	470		2.700	15.000	4000870 286951	✓	<b>286.95</b>
<b>A T G</b> <b>E</b>	7	E27	60	106	806		2.700	15.000	4000870 286968	✓	<b>286.96</b>
<b>A T G</b> <b>E</b>	9	E27	60	106	1.055		2.700	15.000	4000870 286197	✓	<b>286.19</b>
<b>A T G</b> <b>E</b>	11,5	E27	67	110	1.521		2.700	15.000	4000870 286975	✓	<b>286.97</b>



	W	⊖	∅ mm	⇅ mm	lm	♀	K	⌚	EAN	✓	
<b>A T G</b> <b>F</b>	2x5	E27	60	108	470		2.700	15.000	4000870 288566	✓	<b>new 288.56</b>
<b>A T G</b> <b>E</b>	2x7	E27	60	106	806		2.700	15.000	4000870 286418	✓	<b>286.41</b>



 dimmable

	W	⊖	∅ mm	⇅ mm	lm	♀	K	⌚	EAN	✓	
<b>A T G</b> <b>F</b>	5	E27	60	106	470		2.700	15.000	4000870 286166	✓	<b>286.16</b>
<b>A T G</b> <b>F</b>	7,5	E27	60	106	806		2.700	15.000	4000870 286982	✓	<b>286.98</b>
<b>A T G</b> <b>E</b>	9	E27	60	106	1.055		2.700	15.000	4000870 286203	✓	<b>286.20</b>
<b>A T G</b> <b>E</b>	12,5	E27	70	126	1,521		2.700	20.000	4000870 286470	✓	<b>286.47</b>



 3 step dim

## Klar Clair Helder

	W	⊖	∅ mm	⇅ mm	lm	♀	K	⌚	EAN	✓	
<b>A T G</b> <b>F</b>	5	E27	60	104	470		2.700	15.000	4000870 285701	✓	<b>285.70</b>
<b>A T G</b> <b>F</b>	8	E27	60	104	806		2.700	15.000	4000870 285718	✓	<b>285.71</b>



 dimmable

## Klar Clair Helder

	W	⊖	∅ mm	⇅ mm	lm	♀	K	⌚	EAN	✓	
<b>A T G</b> <b>E</b>	15	E27	70	135	2.000		2.700	15.000	4000870 288177	✓	<b>new 288.17</b>



 dim to warm

## Klar Clair Helder

	W	⊖	∅ mm	⇅ mm	lm	♀	K	⌚	EAN	✓	
<b>A T G</b> <b>E</b>	7	E27	60	105	806		1.800 - 3.000	15.000	4000870 287767	✓	<b>287.76</b>



Matt Dépoli Mat



	W	⊖	∅ mm	⇅ mm	lm	♀	K	⌚	EAN	☑	
<b>A</b> <b>G</b>	3	E27	60	106	250		2.700	15.000	4000870 286159	☑	<b>286.15</b>
<b>A</b> <b>F</b>	5	E27	60	106	470		2.700	15.000	4000870 286173	☑	<b>286.17</b>
<b>A</b> <b>E</b>	7	E27	60	106	806		2.700	15.000	4000870 286180	☑	<b>286.18</b>
<b>A</b> <b>E</b>	9	E27	60	106	1.055		2.700	15.000	4000870 286210	☑	<b>286.21</b>

	W	⊖	∅ mm	⇅ mm	lm	♀	K	⌚	EAN	☑	
<b>A</b> <b>E</b>	2x7	E27	60	106	806		2.700	15.000	4000870 286425	☑	<b>286.42</b>

Matt Dépoli Mat



	W	⊖	∅ mm	⇅ mm	lm	♀	K	⌚	EAN	☑	
<b>A</b> <b>F</b>	5,1	E27	60	106	470		2.700	15.000	4000870 286999	☑	<b>286.99</b>
<b>A</b> <b>F</b>	7,5	E27	60	106	806		2.700	15.000	4000870 287002	☑	<b>287.00</b>
<b>A</b> <b>E</b>	9	E27	60	106	1.055		2.700	15.000	4000870 286227	☑	<b>286.22</b>

Matt Dépoli Mat



	W	⊖	∅ mm	⇅ mm	lm	♀	K	⌚	EAN	☑	
<b>A</b> <b>F</b>	7,5	E27	60	106	806		4.000	15.000	4000870 287293	☑	<b>287.29</b>
<b>A</b> <b>E</b>	9	E27	60	106	1.055		4.000	15.000	4000870 288153	☑	<b>288.15</b>

Matt Dépoli Mat



	W	⊖	∅ mm	⇅ mm	lm	♀	K	⌚	EAN	☑	
<b>A</b> <b>F</b>	7,5	E27	60	106	806		6.500	15.000	4000870 287620	☑	<b>287.62</b>
<b>A</b> <b>E</b>	9	E27	60	106	1.055		6.500	15.000	4000870 288160	☑	<b>288.16</b>

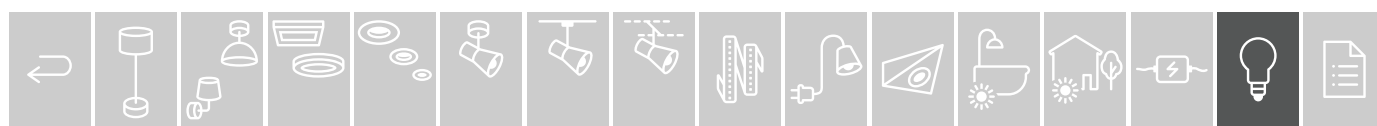



Klar Clair Helder



	W	⊖	ø mm	⇅ mm	lm	♀	K	⌚	EAN	☑	R, C
<b>A</b> <b>F</b>	7,5	E27	64	140	806		2.700	15.000	4000870 287033	✓	<b>287.03</b>



Klar Clair Helder



	W	⊖	ø mm	⇅ mm	lm	♀	K	⌚	EAN	☑	R, L, C
<b>A</b> <b>E</b>	7	E27	95	140	806		1.800 - 3.000	15.000	4000870 287798	✓	<b>287.79</b>



Opal Opale Opaal



	W	⊖	ø mm	⇅ mm	lm	♀	K	⌚	EAN	☑	R, C
<b>A</b> <b>G</b>	5,6	E27	80	120	470		2.700	15.000	4000870 286234	✓	<b>286.23</b>
<b>A</b> <b>F</b>	7,5	E27	80	118	806		2.700	15.000	4000870 287019	✓	<b>287.01</b>



	W	⊖	ø mm	⇅ mm	lm	♀	K	⌚	EAN	☑	R, C
<b>A</b> <b>G</b>	5,6	E27	95	138	470		2.700	15.000	4000870 286241	✓	<b>286.24</b>
<b>A</b> <b>F</b>	7,5	E27	95	140	806		2.700	15.000	4000870 287026	✓	<b>287.02</b>
<b>A</b> <b>E</b>	9	E27	95	138	1.055		2.700	15.000	4000870 286258	✓	<b>286.25</b>



	W	⊖	ø mm	⇅ mm	lm	♀	K	⌚	EAN	☑	R, C
<b>A</b> <b>G</b>	5,6	E27	125	173	470		2.700	15.000	4000870 286265	✓	<b>286.26</b>
<b>A</b> <b>E</b>	7	E27	125	173	806		2.700	15.000	4000870 286272	✓	<b>286.27</b>
<b>A</b> <b>E</b>	9	E27	125	173	1.055		2.700	15.000	4000870 286289	✓	<b>286.28</b>





LED 1879 Edition

Gold Doré Goud



W	⚡	∅ mm	⇅ mm	lm	♀	K	⌚	EAN	☑	
2	E14	35	97	160		1.700	15.000	4000870 285244	☑	285.24

W	⚡	∅ mm	⇅ mm	lm	♀	K	⌚	EAN	☑	
2	E14	45	78	160		1.700	15.000	4000870 285251	☑	285.25

W	⚡	∅ mm	⇅ mm	lm	♀	K	⌚	EAN	☑	
6	E27	60	104	470		1.700	15.000	4000870 285220	☑	285.22

W	⚡	∅ mm	⇅ mm	lm	♀	K	⌚	EAN	☑	
2	E14	25	80	145		1.700	15.000	4000870 285268	☑	285.26

W	⚡	∅ mm	⇅ mm	lm	♀	K	⌚	EAN	☑	
8,5	E27	30	300	806		2.500	15.000	4000870 288313	☑	new 288.31

W	⚡	∅ mm	⇅ mm	lm	♀	K	⌚	EAN	☑	
2,7	E27	64	145	150		1.800	15.000	4000870 284063	☑	284.06

W	⚡	∅ mm	⇅ mm	lm	♀	K	⌚	EAN	☑	
4,4	E27	64	145	250		1.700	15.000	4000870 284070	☑	284.07

W	⚡	∅ mm	⇅ mm	lm	♀	K	⌚	EAN	☑	
6	E27	64	145	480		1.700	15.000	4000870 285237	☑	285.23

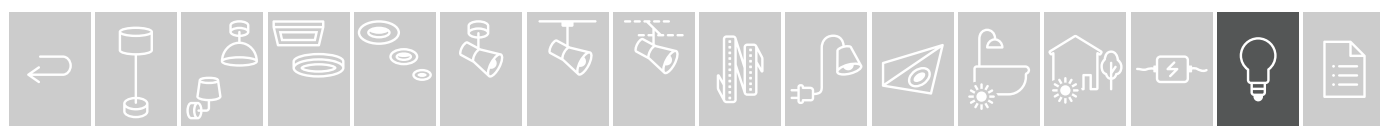



Gold Doré Goud

W	⚡	∅ mm	⇅ mm	lm	✂	K	⌚	EAN	📦	
2,7	E27	95	138	170		1.800	15.000	4000870 283998	✓	283.99
6,5	E27	95	138	400		1.700	15.000	4000870 284001	✓	284.00



  
dimmable

Gold Doré Goud

W	⚡	∅ mm	⇅ mm	lm	✂	K	⌚	EAN	📦	
6	E27	95	138	450		1.700	15.000	4000870 285213	✓	285.21 



Gold Doré Goud

W	⚡	∅ mm	⇅ mm	lm	✂	K	⌚	EAN	📦	
2,7	E27	125	175	170		1.700	15.000	4000870 284018	✓	284.01
4,4	E27	125	175	250		1.700	15.000	4000870 284025	✓	284.02
6,5	E27	125	175	420		1.700	15.000	4000870 284032	✓	284.03



Gold Doré Goud

W	⚡	∅ mm	⇅ mm	lm	✂	K	⌚	EAN	📦	
4	E27	125	175	230		1.800	15.000	4000870 288696		new 288.69

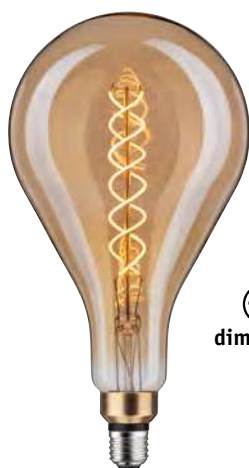

  
dimmable

Gold Doré Goud

W	⚡	∅ mm	⇅ mm	lm	✂	K	⌚	EAN	📦	
7	E27	160	300	400		1.800	15.000	4000870 288672		new 288.67 



  
dimmable

Gold Doré Goud

W	⚡	∅ mm	⇅ mm	lm	✂	K	⌚	EAN	📦	
7	E27	200	300	400		1.800	15.000	4000870 288689		new 288.68 

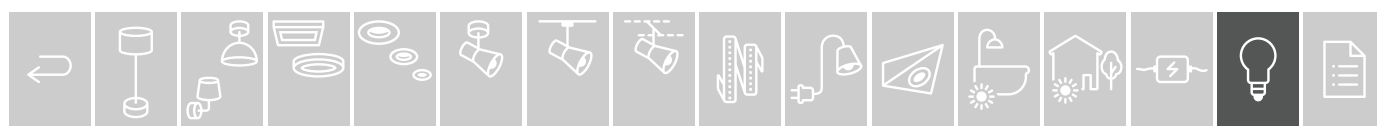



LED 1879 Edition

☞ Rauchglas Verre fumé Rookglas



 dimmable

W	⚡	∅ mm	⇅ mm	lm	✂	K	⌚	EAN	☑	R, C
4	E14	35	98	145		1.800	15.000	4000870 288627	✓	new 288.62



 dimmable

W	⚡	∅ mm	⇅ mm	lm	✂	K	⌚	EAN	☑	R, C
4	E14	45	78	170		1.800	15.000	4000870 288634	✓	new 288.63



 dimmable

W	⚡	∅ mm	⇅ mm	lm	✂	K	⌚	EAN	☑	R, C
7,5	E27	60	106	350		1.800	15.000	4000870 288610	✓	new 288.61



 dimmable

W	⚡	∅ mm	⇅ mm	lm	✂	K	⌚	EAN	☑	R, C
4	E14	25	82	130		1.800	15.000	4000870 288665	✓	new 288.66

 dimmable



W	⚡	∅ mm	⇅ mm	lm	✂	K	⌚	EAN	☑	R, C
8,8	E27	30	300	806		2.700	15.000	4000870 288320	✓	new 288.32



 dimmable

W	⚡	∅ mm	⇅ mm	lm	✂	K	⌚	EAN	☑	R, C
7,5	E27	64	140	320		1.800	15.000	4000870 288641	✓	new 288.64









 dimmable

 Rauchglas Verre fumé Rookglas

W	⚡	∅ mm	⇅ mm	lm	✂	K	⌚	EAN	📦	
8,0	E27	95	140	360		1.800	15.000	4000870 288658	✓	new <b>288.65</b>



 dimmable

 Rauchglas Verre fumé Rookglas

W	⚡	∅ mm	⇅ mm	lm	✂	K	⌚	EAN	📦	
4	E27	125	175	130		1.800	15.000	4000870 288603		new <b>288.60</b>



 dimmable

 Rauchglas Verre fumé Rookglas

W	⚡	∅ mm	⇅ mm	lm	✂	K	⌚	EAN	📦	
7	E27	160	300	200		1.800	15.000	4000870 288580		new <b>288.58</b>



 dimmable

 Rauchglas Verre fumé Rookglas

W	⚡	∅ mm	⇅ mm	lm	✂	K	⌚	EAN	📦	
7	E27	200	300	200		1.800	15.000	4000870 288597		new <b>288.59</b>



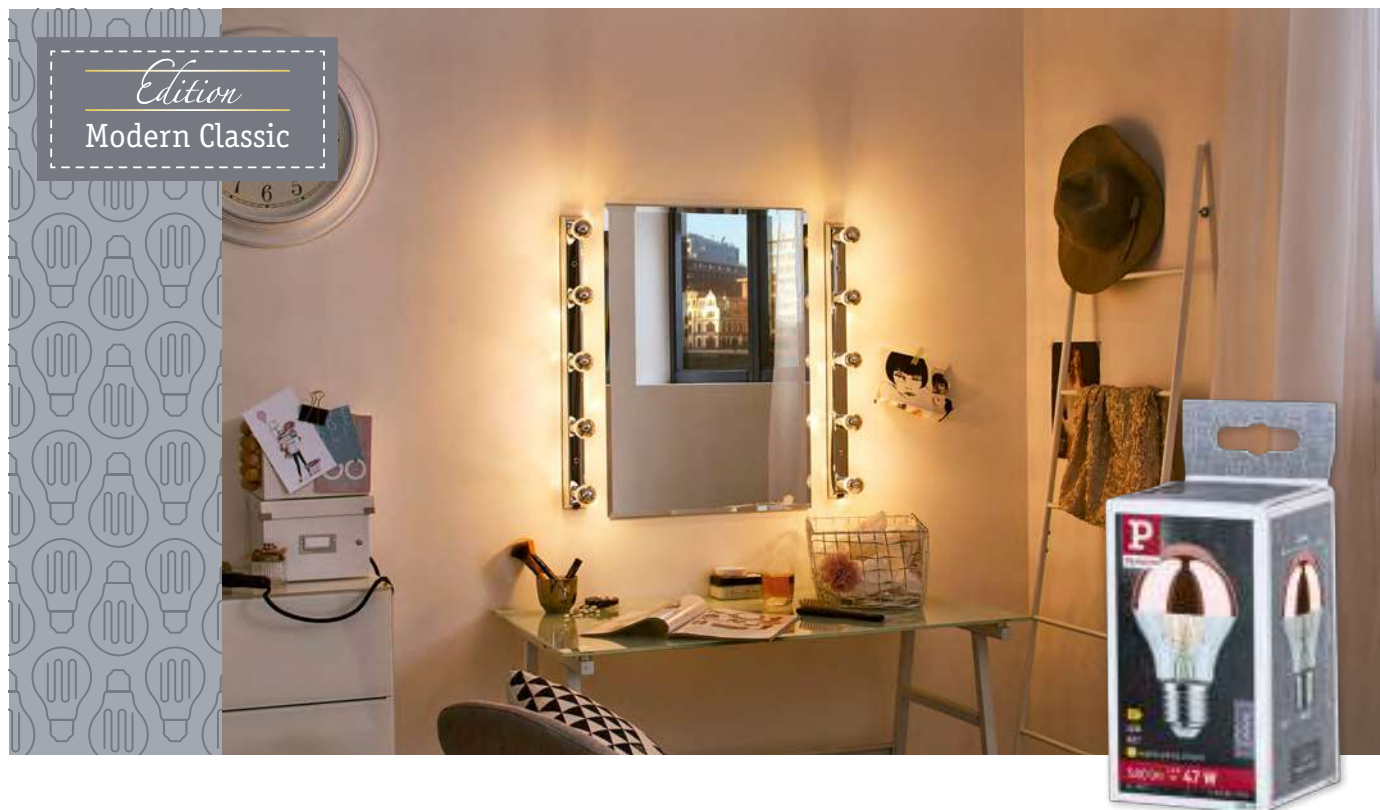

*Edition*  
Modern Classic

LED Decorative

🔗 Kopfspiegel Silber Calotte argentée Kopspegel zilver



W	⚡	∅ mm	↑ mm	lm	⚡	K	⌚	EAN	✓	
<b>2,6</b>	E14	45	78	220		2.700	15.000	4000870 286630	✓	<b>286.63</b>

🔗 Kopfspiegel Silber Calotte argentée Kopspegel zilver



dimmable

W	⚡	∅ mm	↑ mm	lm	⚡	K	⌚	EAN	✓	
<b>4,8</b>	E14	45	78	440		2.700	15.000	4000870 286678	✓	<b>286.67</b>

🔗 Kopfspiegel Kupfer Calotte réflectrice en cuivre Kopspegel koper



W	⚡	∅ mm	↑ mm	lm	⚡	K	⌚	EAN	✓	
<b>2,6</b>	E14	45	78	220		2.700	15.000	4000870 286654	✓	<b>286.65</b>

🔗 Kopfspiegel Silber Calotte argentée Kopspegel zilver



W	⚡	∅ mm	↑ mm	lm	⚡	K	⌚	EAN	✓	
<b>2,6</b>	E27	45	72	220		2.700	15.000	4000870 286647	✓	<b>286.64</b>
<b>4,8</b>	E27	45	72	360		2.700	15.000	4000870 286685	✓	<b>286.68</b>

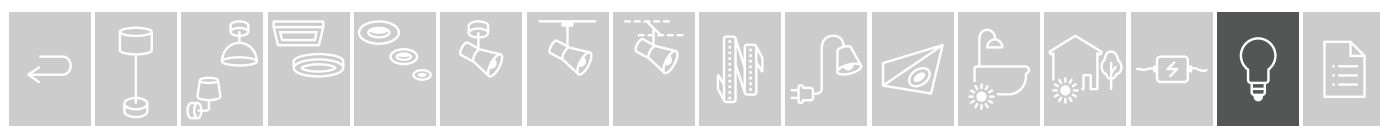



☞ Kopfspiegel Silber Calotte argentée Kopspegel zilver

	W	⚡	∅ mm	⇅ mm	lm	✂	K	⌚	EAN	☑	
<b>A</b> <b>E</b>	4,8	E27	60	106	580		2.700	15.000	4000870 286692	✓	<b>286.69</b>
<b>A</b> <b>F</b>	6,5	E27	60	106	600		2.700	15.000	4000870 286708	✓	<b>286.70</b>



☞ Kopfspiegel Kupfer Calotte réfléchrice en cuivre Kopspegel koper

	W	⚡	∅ mm	⇅ mm	lm	✂	K	⌚	EAN	☑	
<b>A</b> <b>F</b>	6,5	E27	60	106	600		2.700	15.000	4000870 286715	✓	<b>286.71</b>



☞ Kopfspiegel Silber Calotte argentée Kopspegel zilver

	W	⚡	∅ mm	⇅ mm	lm	✂	K	⌚	EAN	☑	
<b>A</b> <b>E</b>	4,8	E27	95	138	580		2.700	15.000	4000870 286722	✓	<b>286.72</b>



 dimmable

☞ Kopfspiegel Silber Calotte argentée Kopspegel zilver

	W	⚡	∅ mm	⇅ mm	lm	✂	K	⌚	EAN	☑	
<b>A</b> <b>F</b>	6,5	E27	95	138	600		2.700	15.000	4000870 286739	✓	<b>286.73</b>

 R.C.



☞ Kopfspiegel Kupfer Calotte réfléchrice en cuivre Kopspegel koper

	W	⚡	∅ mm	⇅ mm	lm	✂	K	⌚	EAN	☑	
<b>A</b> <b>F</b>	6,5	E27	95	138	600		2.700	15.000	4000870 286746	✓	<b>286.74</b>

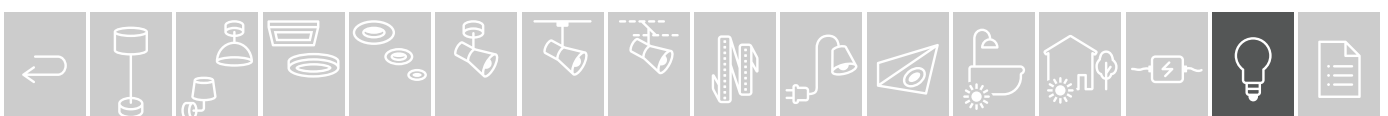



Kopfspiegel Gold Calotte dorée Kopfspiegel goud

dimmable

AGF	W	⊖	∅ mm	⇅ mm	lm	⚡	K	⌚	EAN	✓	R, C
F	6,5	E27	95	138	600		2.700	15.000	4000870 286753	✓	286.75



Kopfspiegel Schwarz matt Calotte réfléchrice en noir mat Kopfspiegel zwart mat

dimmable

AGF	W	⊖	∅ mm	⇅ mm	lm	⚡	K	⌚	EAN	✓	R, C
F	6,5	E27	95	138	600		2.700	15.000	4000870 286760	✓	286.76



Kopfspiegel Schwarzchrom Calotte réfléchrice en chrome noir Kopfspiegel black chrom

dimmable

AGF	W	⊖	∅ mm	⇅ mm	lm	⚡	K	⌚	EAN	✓	R, C
F	6,5	E27	95	138	600		2.700	15.000	4000870 286777	✓	286.77



Kopfspiegel Gold Calotte dorée Kopfspiegel goud

dimmable

AGF	W	⊖	∅ mm	⇅ mm	lm	⚡	K	⌚	EAN	✓	R, C
F	6,5	E27	125	174	600		2.700	15.000	4000870 286784	✓	286.78

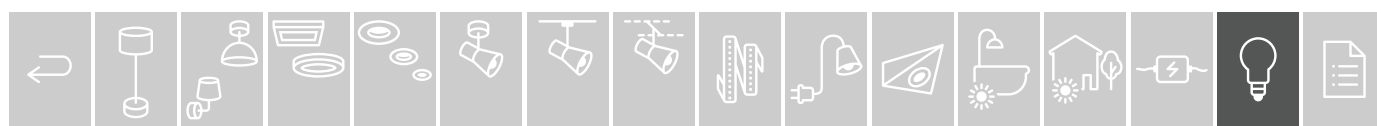



🔗 Kopfspiegel Schwarz matt Calotte réfléchrice en noir mat Kopspiegel zwart mat

dimmable

W	⚡	∅ mm	⇅ mm	Lm	⚡	K	⌚	EAN	📦	R, C
6,5	E27	125	174	600		2.700	15.000	4000870 286791	✓	286.79



🔗 Kopfspiegel Schwarzchrom Calotte réfléchrice en chrome noir Kopspiegel black chrom

dimmable

W	⚡	∅ mm	⇅ mm	Lm	⚡	K	⌚	EAN	📦	R, C
6,5	E27	125	174	600		2.700	15.000	4000870 286807	✓	286.80



🔗 Ringspiegel Silber Anneau réfléchissant argentée Ringspiegel zilver

dimmable

W	⚡	∅ mm	⇅ mm	Lm	⚡	K	⌚	EAN	📦	R, C
6,5	E27	125	174	640		2.700	15.000	4000870 286814	✓	286.81



🔗 Ringspiegel Schwarz matt Anneau réfléchissant en noir mat Ringspiegel zwart mat

dimmable

W	⚡	∅ mm	⇅ mm	Lm	⚡	K	⌚	EAN	📦	R, C
6,5	E27	125	174	640		2.700	15.000	4000870 286821	✓	286.82

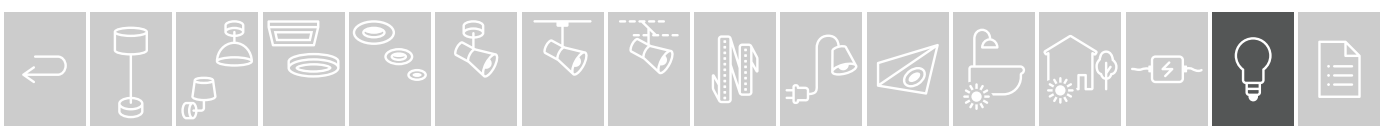



 dimmable

 Ringspiegel gold Anneau réfléchissant doré Ringspiegel goud

W	⊖	∅ mm	⇅ mm	Lm	⚡	K	⌚	EAN	✓	R, C
 4,5	E27	125	170	420		2.500	15.000	4000870 287705	✓	<b>287.70</b>



 dimmable

 Ringspiegel Silber Anneau réfléchissant argentée Ringspiegel zilver

W	⊖	∅ mm	⇅ mm	Lm	⚡	K	⌚	EAN	✓	R, C
 4,5	E27	125	170	420		2.600	15.000	4000870 287422	✓	<b>287.42</b>



 dimmable

 Ringspiegel schwarz Anneau réfléchissant noir Ringspiegel zwart

W	⊖	∅ mm	⇅ mm	Lm	⚡	K	⌚	EAN	✓	R, C
 4,5	E27	125	170	340		2.600	15.000	4000870 287439	✓	<b>287.43</b>



 dimmable

 Ringspiegel weiß Anneau réfléchissant blanc Ringspiegel wit

W	⊖	∅ mm	⇅ mm	Lm	⚡	K	⌚	EAN	✓	R, C
 4,5	E27	125	170	470		2.600	15.000	4000870 287446	✓	<b>287.44</b>

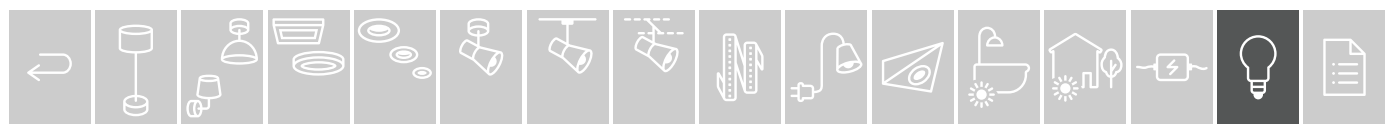



Matt Dépoli Mat

	W	⊖	∅ mm	⇅ mm	lm	✂	K	⌚	EAN	☑	R, C
<b>A G E</b>	4	E27	95	150	450		2.700	15.000	4000870 287682	✓	<b>287.68</b>

Matt Dépoli Mat

	W	⊖	∅ mm	⇅ mm	lm	✂	K	⌚	EAN	☑	R, C
<b>A G F</b>	4	E27	125	187	400		2.700	15.000	4000870 287644	✓	<b>287.64</b>



Gold Doré Goud

	W	⊖	∅ mm	⇅ mm	lm	✂	K	⌚	EAN	☑	R, C
<b>A G F</b>	4	E27	95	150	400		2.700	15.000	4000870 287699	✓	<b>287.69</b>

Gold Doré Goud

	W	⊖	∅ mm	⇅ mm	lm	✂	K	⌚	EAN	☑	R, C
<b>A G F</b>	4	E27	125	187	400		2.700	15.000	4000870 287651	✓	<b>287.65</b>



Rauchglas Verre fumé Rookglas

	W	⊖	∅ mm	⇅ mm	lm	✂	K	⌚	EAN	☑	R, C
<b>A G R</b>	4	E27	95	150	270		2.700	15.000	4000870 287668	✓	<b>287.66</b>

Rauchglas Verre fumé Rookglas

	W	⊖	∅ mm	⇅ mm	lm	✂	K	⌚	EAN	☑	R, C
<b>A G R</b>	4	E27	125	187	300		2.700	15.000	4000870 287637	✓	<b>287.63</b>





**Inner Glow**

Inner Glow – Vollkommen blendfreie Goldglas-Lampen mit innerem LeuchtKolben bringen extra warme Lichtakzente in jeden Wohnraum. Erhältlich in drei Bauformen mit zwei unterschiedlichen Lasergravur-Mustern.

**Inner Glow**

Inner Glow – les lampes en verre doré absolument anti-éblouissement avec ampoule intérieure procurent dans chaque séjour des touches lumineuses très chaleureuses. Disponibles en trois formes avec deux motifs de gravure laser différents.

**Inner Glow**

Inner Glow – niet verblindende, goudkleurige glazen lampen met lichtkolf aan de binnenzijde zorgen voor extra warme lichtaccenten in elke woonruimte. Verkrijgbaar in drie designs met twee verschillende lasergegraveerde patronen.



Gold Doré Goud



W	⚡	∅ mm	⇅ mm	Lm	✂	K	⌚	EAN	✓	
4	E27	64	145	200		1.800	15.000	4000870 285985	✓	<b>285.98</b>

Gold Doré Goud



W	⚡	∅ mm	⇅ mm	Lm	✂	K	⌚	EAN	✓	
4	E27	64	145	200		1.800	15.000	4000870 285992	✓	<b>285.99</b>







dimmable

Gold Doré Goud



W	⊖	∅ mm	⇅ mm	lm	✂	K	⌚	EAN	☑	new
3,6	E27	64	142	120		1.800	15.000	4000870 288290	✓	288.29



dimmable

Gold Doré Goud



W	⊖	∅ mm	⇅ mm	lm	✂	K	⌚	EAN	☑	new
3,6	E27	64	142	120		1.800	15.000	4000870 288306	✓	288.30



Gold Doré Goud



W	⊖	∅ mm	⇅ mm	lm	✂	K	⌚	EAN	☑	
4	E27	75	165	200		1.800	15.000	4000870 286005	✓	286.00

Gold Doré Goud



W	⊖	∅ mm	⇅ mm	lm	✂	K	⌚	EAN	☑	
4	E27	75	165	200		1.800	15.000	4000870 286012	✓	286.01



dimmable

Gold Doré Goud



W	⊖	∅ mm	⇅ mm	lm	✂	K	⌚	EAN	☑	new
3,6	E27	75	162	120		1.800	15.000	4000870 288276	✓	288.27

Gold Doré Goud



W	⊖	∅ mm	⇅ mm	lm	✂	K	⌚	EAN	☑	new
3,6	E27	75	162	120		1.800	15.000	4000870 288283	✓	288.28



Gold Doré Goud



W	⊖	∅ mm	⇅ mm	lm	✂	K	⌚	EAN	☑	
4	E27	95	145	200		1.800	15.000	4000870 286029	✓	286.02

Gold Doré Goud



W	⊖	∅ mm	⇅ mm	lm	✂	K	⌚	EAN	☑	
4	E27	95	145	200		1.800	15.000	4000870 286036	✓	286.03





Wei/Silber Blanc/Argent Wit/Zilver

	W	⊖	∅ mm	⇅ mm	lm	⚡	K	⌚	EAN	✓	new
<b>A G</b>	<b>4,9</b>	GU5,3	100	58	440		3.000	15.000	4000870 288023	✓	<b>288.02</b>
	7 VA										



Wei Blanc Wit

	W	⊖	∅ mm	⇅ mm	lm	⚡	K	⌚	EAN	✓	new
<b>A G</b>	<b>4,9</b>	GU5,3	100	58	440		3.000	15.000	4000870 288030	✓	<b>288.03</b>
	7 VA										



Schwarz/Gold Noir/Dor Zwart/Goud

	W	⊖	∅ mm	⇅ mm	lm	⚡	K	⌚	EAN	✓	new
<b>A G</b>	<b>4,9</b>	GU5,3	100	58	170		1.900	15.000	4000870 288047	✓	<b>288.04</b>
	7 VA										



Schwarz/Wei Noir/Blanc Zwart/Wit

	W	⊖	∅ mm	⇅ mm	lm	⚡	K	⌚	EAN	✓	new
<b>A G</b>	<b>4,9</b>	GU5,3	100	58	440		3.000	15.000	4000870 288054	✓	<b>288.05</b>
	7 VA										



3 step dim

Silber/Wei Argent/Blanc Zilver/Wit

	W	⊖	∅ mm	⇅ mm	lm	⚡	K	⌚	EAN	✓	new
<b>A G</b>	<b>4,9</b>	GU10	100	66	360		3.000	15.000	4000870 287927	✓	<b>287.92</b>

3 step dim



3 step dim

Wei Blanc Wit

	W	⊖	∅ mm	⇅ mm	lm	⚡	K	⌚	EAN	✓	new
<b>A G</b>	<b>4,9</b>	GU10	100	66	360		3.000	15.000	4000870 287934	✓	<b>287.93</b>

3 step dim



3 step dim

Schwarz/Gold Noir/Dor Zwart/Goud

	W	⊖	∅ mm	⇅ mm	lm	⚡	K	⌚	EAN	✓	new
<b>A G</b>	<b>4,9</b>	GU10	100	66	170	55	1.900	15.000	4000870 287941	✓	<b>287.94</b>

3 step dim



3 step dim

Schwarz/Wei Noir/Blanc Zwart/Wit

	W	⊖	∅ mm	⇅ mm	lm	⚡	K	⌚	EAN	✓	new
<b>A G</b>	<b>4,9</b>	GU10	100	66	360		3.000	15.000	4000870 287958	✓	<b>287.95</b>

3 step dim



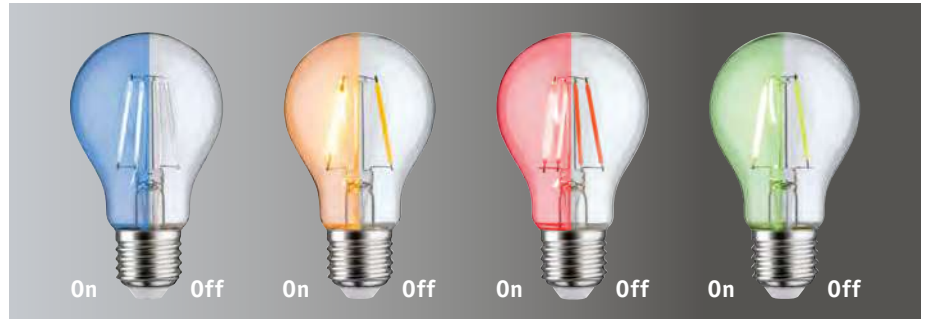

☞ Klar Clair Helder

W	⚡	∅ mm	⇅ mm	lm	⚡	K	⌚	EAN	☑	DECO
2,2	E27	60	106	40		1.000	15.000	4000870 287217	✓	287.21



☞ Klar Clair Helder

W	⚡	∅ mm	⇅ mm	lm	⚡	K	⌚	EAN	☑	DECO
1,3	E27	60	106	40		1.000	15.000	4000870 287231	✓	287.23



☞ Klar Clair Helder

W	⚡	∅ mm	⇅ mm	lm	⚡	K	⌚	EAN	☑	DECO
1,1	E27	60	106	170		4.900	15.000	4000870 287248	✓	287.24



☞ Klar Clair Helder

W	⚡	∅ mm	⇅ mm	lm	⚡	K	⌚	EAN	☑	DECO
1,1	E27	60	106	100		2.000	15.000	4000870 287224	✓	287.22





*Edition*  
Vintage



Gold Doré Goud

	W	⊖	∅ mm	⇅ mm	lm	✂	K	⌚	EAN	☑	
<b>AG F</b>	2,6	E14	35	98	260		2.500	15.000	4000870 287040	✓	<b>287.04</b>



 dimmable

	W	⊖	∅ mm	⇅ mm	lm	✂	K	⌚	EAN	☑	
<b>AG F</b>	4,7	E14	35	98	430		2.500	15.000	4000870 287057	✓	<b>287.05</b>





Klar Clair Helder

	W	⊖	∅ mm	⇅ mm	lm	✂	K	⌚	EAN	☑	
<b>AG F</b>	2,6	E14	35	98	280		2.700	15.000	4000870 287064	✓	<b>287.06</b>



 dimmable

	W	⊖	∅ mm	⇅ mm	lm	✂	K	⌚	EAN	☑	
<b>AG F</b>	4,7	E14	35	98	450		2.700	15.000	4000870 287071	✓	<b>287.07</b>





Gold Doré Goud

	W	⊖	∅ mm	⇅ mm	lm	✂	K	⌚	EAN	☑	
<b>AG F</b>	2,6	E14	35	98	260		2.500	15.000	4000870 287088	✓	<b>287.08</b>



 dimmable

	W	⊖	∅ mm	⇅ mm	lm	✂	K	⌚	EAN	☑	
<b>AG F</b>	4,7	E14	35	98	430		2.500	15.000	4000870 287095	✓	<b>287.09</b>



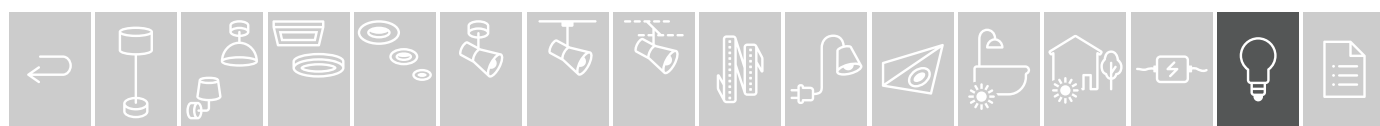



Gold Doré Goud

ATG	F	W	⊖	∅ mm	⇅ mm	lm	✂	K	⊕	EAN	✓	
		2,6	E14	45	78	260		2.500	15.000	4000870 287118	✓	287.11



dimmable

ATG	F	W	⊖	∅ mm	⇅ mm	lm	✂	K	⊕	EAN	✓	
		4,7	E14	45	78	430		2.500	15.000	4000870 287125	✓	287.12

R, C



Gold Doré Goud

ATG	F	W	⊖	∅ mm	⇅ mm	lm	✂	K	⊕	EAN	✓	
		2,6	E27	45	72	260		2.500	15.000	4000870 287101	✓	287.10



dimmable

ATG	F	W	⊖	∅ mm	⇅ mm	lm	✂	K	⊕	EAN	✓	
		4,7	E27	45	72	430		2.500	15.000	4000870 287132	✓	287.13

R, C



Gold Doré Goud

ATG	F	W	⊖	∅ mm	⇅ mm	lm	✂	K	⊕	EAN	✓	
		4,7	E27	60	106	500		2.500	15.000	4000870 287149	✓	287.14

ATG	F	W	⊖	∅ mm	⇅ mm	lm	✂	K	⊕	EAN	✓	
		6,5	E27	60	106	680		2.500	15.000	4000870 287156	✓	287.15



Gold Doré Goud

ATG	F	W	⊖	∅ mm	⇅ mm	lm	✂	K	⊕	EAN	✓	
		6,5	E27	95	138	680		2.500	15.000	4000870 287163	✓	287.16



Gold Doré Goud

ATG	F	W	⊖	∅ mm	⇅ mm	lm	✂	K	⊕	EAN	✓	
		6,5	E27	64	140	680		2.500	15.000	4000870 287170	✓	287.17





Edition  
Miracle Mosaic

LED lamp  
inside 5W  
E14  
2700K  
470lm  
E27

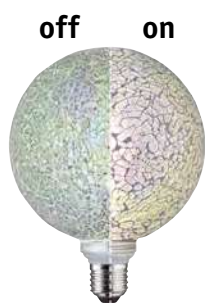

Weiß Blanc Wit



W	⚡	∅ mm	⇅ mm	lm	♀	K	⌚	EAN	Ⓜ	R.C.
5	E27	130	170	470		2.700	15.000	4000870 287453	✓	287.45



Schwarz Noir Zwart



W	⚡	∅ mm	⇅ mm	lm	♀	K	⌚	EAN	Ⓜ	R.C.
5	E27	130	170	470		2.700	15.000	4000870 287460	✓	287.46

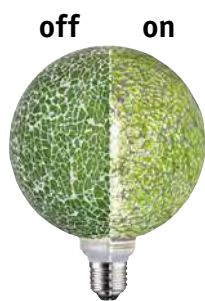

Grün Vert Groen



W	⚡	∅ mm	⇅ mm	lm	♀	K	⌚	EAN	Ⓜ	R.C.
5	E27	130	170	470		2.700	15.000	4000870 287477	✓	287.47



Blau Bleu Blauw



W	⚡	∅ mm	⇅ mm	lm	♀	K	⌚	EAN	Ⓜ	R.C.
5	E27	130	170	470		2.700	15.000	4000870 287507	✓	287.50

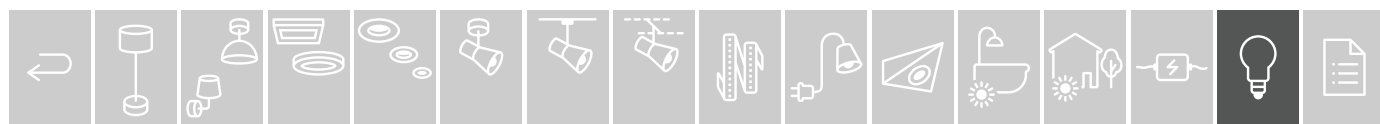



LED Smart Home

Vollglas Filament Lampen

ampoules en verre à filament

glazen filament lampen

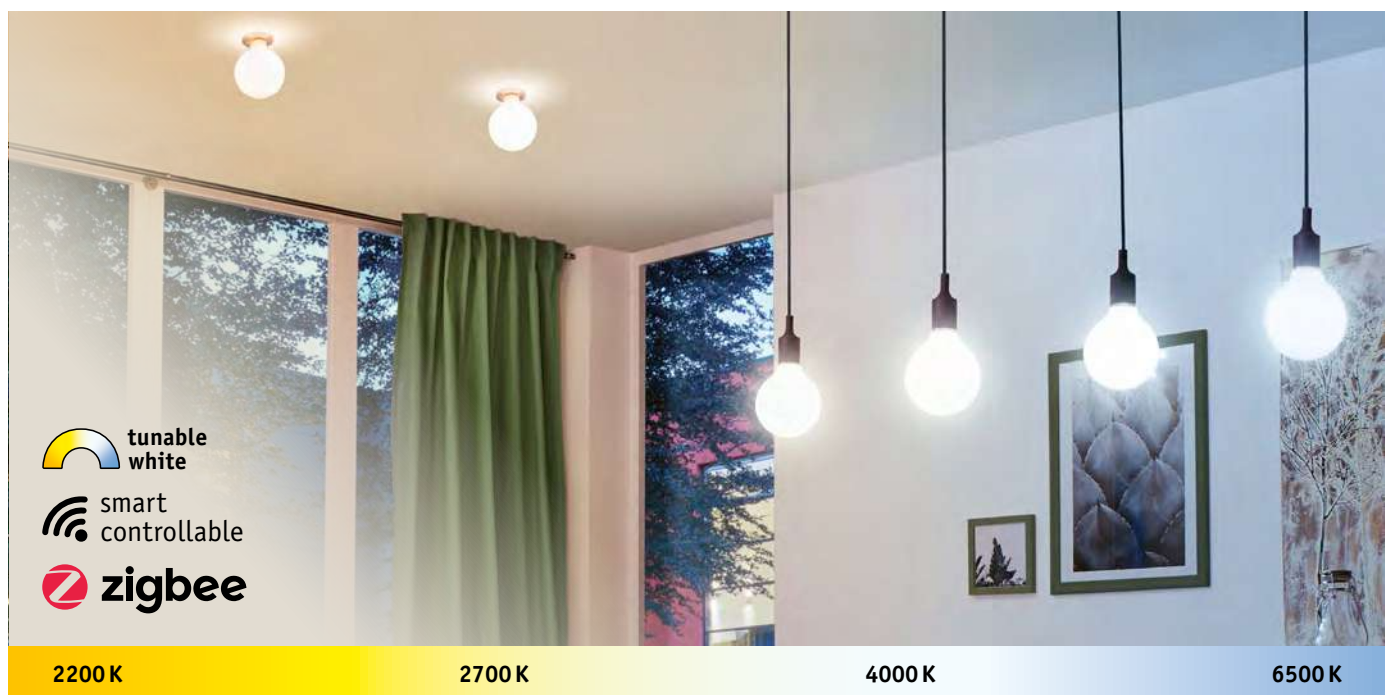

tunable white  
smart controllable  
zigbee

2200 K

2700 K

4000 K

6500 K



tunable white

Matt Dépoli Mat

	W	⊖	∅ mm	⇅ mm	lm	✂	K	⌚	EAN	📶	📶	📶
<b>A</b> <b>F</b>	4,7	E27	60	105	470		2.200 - 6.500	15.000	4000870 503911	📶	📶	📶
<b>A</b> <b>E</b>	7	E27	60	105	806		2.200 - 6.500	15.000	4000870 503928	📶	📶	📶



tunable white

Klar Clair Helder

	W	⊖	∅ mm	⇅ mm	lm	✂	K	⌚	EAN	📶	📶	📶
<b>A</b> <b>F</b>	4,7	E27	60	105	470		2.200 - 6.500	15.000	4000870 503935	📶	📶	📶
<b>A</b> <b>E</b>	7	E27	60	105	806		2.200 - 6.500	15.000	4000870 503942	📶	📶	📶



tunable white

Klar Clair Helder

	W	⊖	∅ mm	⇅ mm	lm	✂	K	⌚	EAN	📶	📶	📶
<b>A</b> <b>E</b>	7	E27	64	140	806		2.200 - 6.500	15.000	4000870 503959	📶	📶	📶



tunable white

Opal Opale Opaal

	W	⊖	∅ mm	⇅ mm	lm	✂	K	⌚	EAN	📶	📶	📶
<b>A</b> <b>E</b>	7	E27	95	134	806		2.200 - 6.500	15.000	4000870 503966	📶	📶	📶

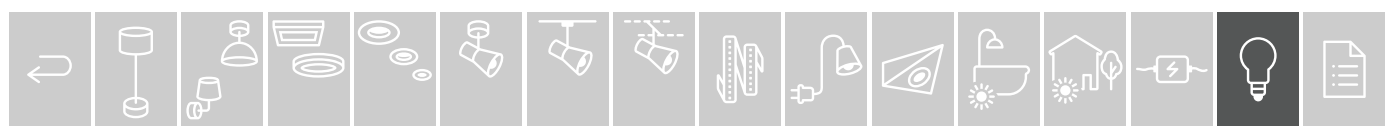



## LED Smart Home

Kunststoff

Matière plastique

Kunststof



dimmable

Matt Dépoli Mat

AG	F	W	⊖	∅ mm	⇅ mm	lm	✂	K	⌚	EAN	✓	
		9	E27	60	118	820		2.700	15.000	4000870 501221		501.22



tunable white

Matt Dépoli Mat

AG	F	W	⊖	∅ mm	⇅ mm	lm	✂	K	⌚	EAN	✓	
		9	E27	60	118	820		2.700 - 6.500	15.000	4000870 501238		501.23



RGBW

Matt Dépoli Mat

AG	F	W	⊖	∅ mm	⇅ mm	lm	✂	K	⌚	EAN	✓	
		9,3	E27	60	118	806		2.700 - 6.500	15.000	4000870 501245		501.24



dimmable

Matt Dépoli Mat

AG	G	W	⊖	∅ mm	⇅ mm	lm	✂	K	⌚	EAN	✓	
		5	E14	38	105	400		2.700	15.000	4000870 501252		501.25



tunable white

Matt Dépoli Mat

AG	G	W	⊖	∅ mm	⇅ mm	lm	✂	K	⌚	EAN	✓	
		5	E14	38	105	400		2.700 - 6.500	15.000	4000870 501269		501.26



RGBW

Matt Dépoli Mat

AG	G	W	⊖	∅ mm	⇅ mm	lm	✂	K	⌚	EAN	✓	
		6,3	E14	38	105	470		2.700 - 6.500	15.000	4000870 501276		501.27



dimmable

Matt Dépoli Mat

AG	G	W	⊖	∅ mm	⇅ mm	lm	✂	K	⌚	EAN	✓	
		5	GU10	50	54	330	36	2.700	15.000	4000870 501283		501.28



tunable white

Matt Dépoli Mat

AG	G	W	⊖	∅ mm	⇅ mm	lm	✂	K	⌚	EAN	✓	
		5	GU10	50	54	330	36	2.700 - 6.500	15.000	4000870 501290		501.29



RGBW

Matt Dépoli Mat

AG	G	W	⊖	∅ mm	⇅ mm	lm	✂	K	⌚	EAN	✓	
		5,5	GU10	50	54	350	36	2.700 - 6.500	15.000	4000870 501306		501.30

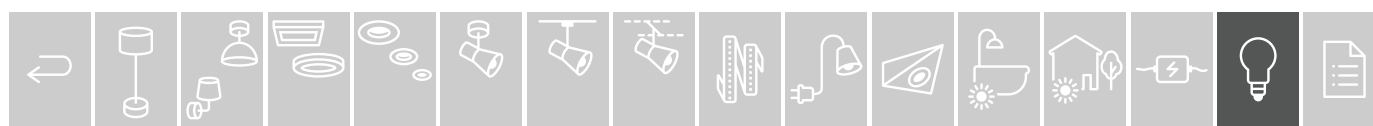

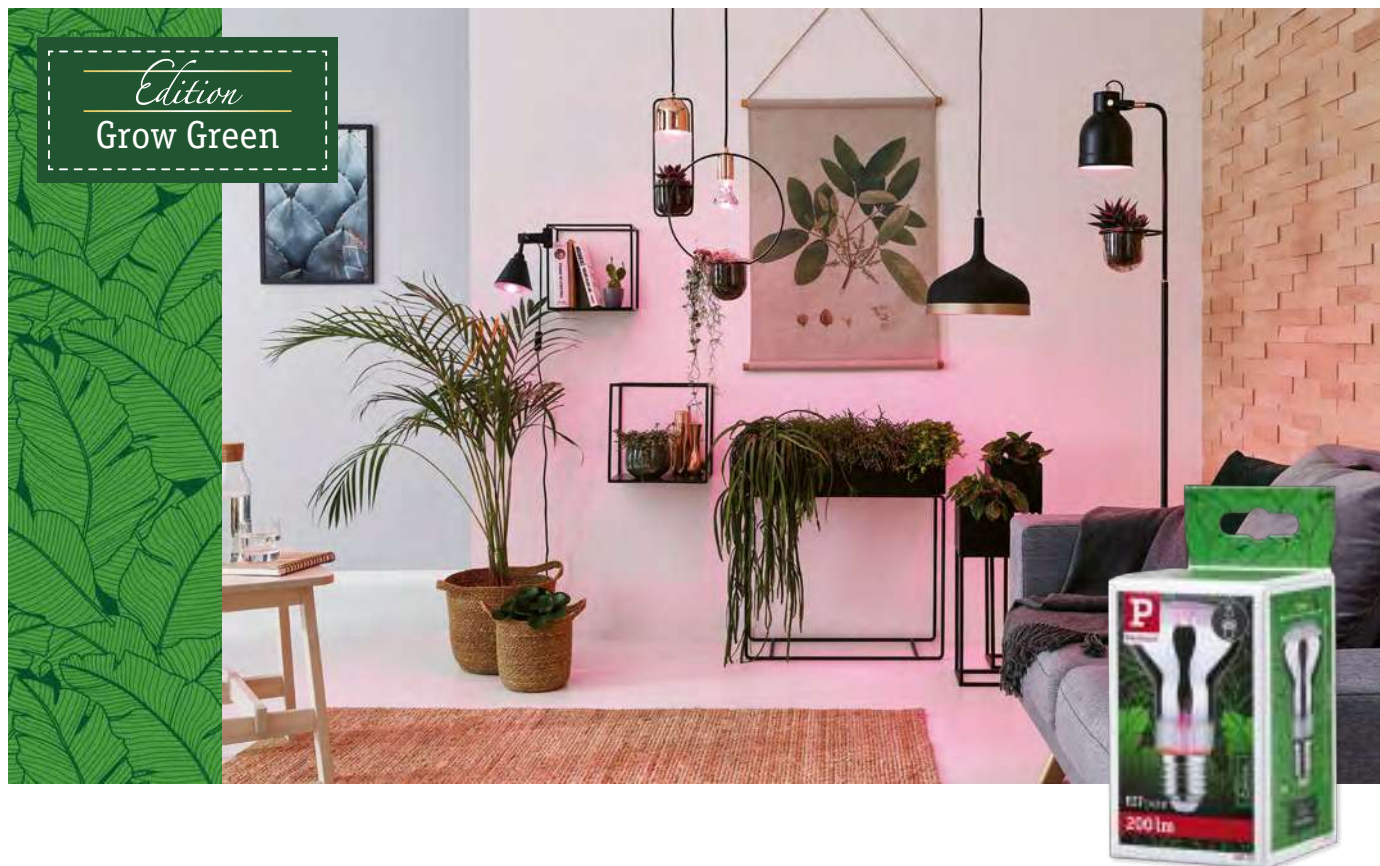

Wachstumslicht Pousse-planté Groeilicht



W	⊖	∅ mm	⇅ mm	lm	⚡	K	⊕	EAN	☑	DECO
3,5	GU10	50	54	65	115	1.100	15.000	4000870 287361	✓	287.36



R50

W	⊖	∅ mm	⇅ mm	lm	⚡	K	⊕	EAN	☑	DECO
4	E14	50	85	100	64	1.300	15.000	4000870 287347	✓	287.34



R63

W	⊖	∅ mm	⇅ mm	lm	⚡	K	⊕	EAN	☑	DECO
6,5	E27	63	105	200	106	1.300	15.000	4000870 287323	✓	287.32



R80

W	⊖	∅ mm	⇅ mm	lm	⚡	K	⊕	EAN	☑	DECO
6,5	E27	80	116	200	60	1.300	15.000	4000870 287330	✓	287.33



PAR38

W	⊖	∅ mm	⇅ mm	lm	⚡	K	⊕	EAN	☑	DECO
6,5	E27	120	148	200	115	1.300	15.000	4000870 287378	✓	287.37

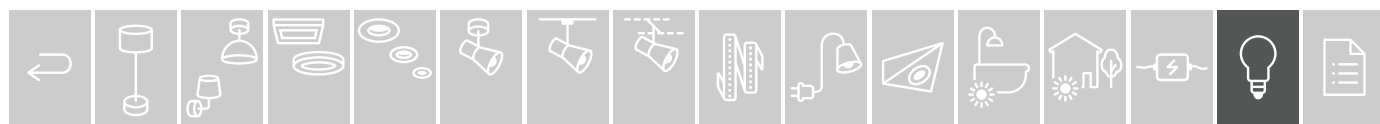

## Energy Saver / Tube fluorescent



Opal Opale Opaal



T5

	W	⚡	∅ mm	⚡ mm	lm	color	K	⌚	EAN	☑	
	22	2GX13	16	223	1.850	827	2.700	12.000	4000870 884485	✓	<b>884.48</b>
	55	2GX13	16	298	4.200	827	2.700	12.000	4000870 884461	✓	<b>884.46</b>



T5

Opal Opale Opaal



	W	⚡	∅ mm	⚡ mm	lm	color	K	⌚	EAN	☑	
	8	G5	16	301	480	830	3.000	5.000	4000870 885086	✓	<b>885.08</b>
	13	G5	16	530	950	830	3.000	5.000	4000870 885130	✓	<b>885.13</b>

	W	⚡	∅ mm	⚡ mm	lm /360°	color	K	⌚	EAN	☑	
	8	G5	16	301	440	840	4.000	5.000	4000870 885604	✓	<b>885.60</b>
	13	G5	16	530	950	840	4.000	5.000	4000870 885611	✓	<b>885.61</b>
	14	G5	16	560	1.205	840	4.000	10.000	4000870 885635	✓	<b>885.63</b>
	21	G5	16	864	1.890	840	4.000	10.000	4000870 885628	✓	<b>885.62</b>





T8

Opal Opale Opaal

	W	⚡	∅ mm	⊕ mm	lm	color	K	⌚	EAN	☑	
	15	G13	26	451	963	827	2.700	8.000	4000870 885154	✓	<b>885.15</b>
	18	G13	26	604	1,350	827	2.700	8.000	4000870 885215	✓	<b>885.21</b>
	30	G13	26	910	2,400	827	2.700	8.000	4000870 885451	✓	<b>885.45</b>
	36	G13	26	1.214	3,348	827	2.700	8.000	4000870 885499	✓	<b>885.49</b>
	58	G13	26	1.515	5,220	827	2.700	8.000	4000870 885536	✓	<b>885.53</b>

	W	⚡	∅ mm	⊕ mm	lm	color	K	⌚	EAN	☑	
	18	G13	26	604	1,350	840	4.000	8.000	4000870 885413	✓	<b>885.41</b>
	36	G13	26	1.214	3,348	840	4.000	8.000	4000870 885505	✓	<b>885.50</b>
	58	G13	26	1.515	5,167	840	4.000	8.000	4000870 885543	✓	<b>885.54</b>

	W	⚡	∅ mm	⊕ mm	lm	color	K	⌚	EAN	☑	
	18	G13	26	604	1,215	865	6.500	8.000	4000870 885192	✓	<b>885.19</b>
	36	G13	26	1.214	3,013	865	6.500	8.000	4000870 885369	✓	<b>885.36</b>
	58	G13	26	1.515	4,698	865	6.500	8.000	4000870 885581	✓	<b>885.58</b>

Weiß Kunststoff  
 Blanc Matière plastique  
 Wit Kunststof



**Starter Universal**

max. 4-65 W  
 ⊕39 ∅20 mm  
 EAN 4000870 884843  
**884.84**



**Starter Tandem/Duo**

max. 2x4-22 W  
 ⊕39 ∅20 mm  
 EAN 4000870 884249  
**884.24**

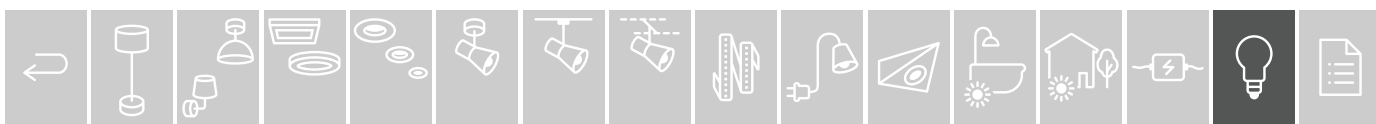





*Conventional Lamps*

Klar Clair Helder



W	⊖	∅ mm	⇅ mm	lm	✂	K	⊕	EAN	📦	
7	E14	25	60	43		2.300	1.000	4000870 800157		<b>800.15</b>

Rot Rouge Rood



W	⊖	∅ mm	⇅ mm	lm	✂	K	⊕	EAN	📦	
15	E14	25	60	26			1.000	4000870 800119		<b>800.11</b>

Gelb Jaune Geel



W	⊖	∅ mm	⇅ mm	lm	✂	K	⊕	EAN	📦	
15	E14	25	60	83			1.000	4000870 800126		<b>800.12</b>

Imatt Dépoli Mat



W	⊖	∅ mm	⇅ mm	lm	✂	K	⊕	EAN	📦	
8	E27	45	70	40		2.300	1.000	4000870 128084		<b>128.08</b>



W	⊖	∅ mm	⇅ mm	lm	✂	K	⊕	EAN	📦	
8	E14	45	78	40		2.300	1.000	4000870 127087		<b>127.08</b>

Imatt Dépoli Mat



W	⊖	∅ mm	⇅ mm	lm	✂	K	⊕	EAN	📦	
8	E27	35	95	40		2.300	1.000	4000870 444085		<b>444.08</b>



W	⊖	∅ mm	⇅ mm	lm	✂	K	⊕	EAN	📦	
8	E14	35	97	40		2.300	1.000	4000870 449080		<b>449.08</b>

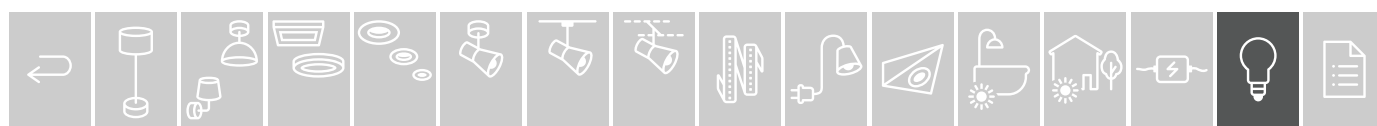



🔗 Klar Clair Helder



W	⚡	∅ mm	⇅ mm	lm	↗	K	⌚	EAN	📦
3	E27	35	95	1			1.000	4000870 531006	531.00

W	⚡	∅ mm	⇅ mm	lm	↗	K	⌚	EAN	📦
3	E14	35	97	1			1.000	4000870 530009	530.00

W	⚡	∅ mm	⇅ mm	lm	↗	K	⌚	EAN	📦
3	E14	35	130	1			1.000	4000870 530030	530.03



🔗 Schwarzlicht Lumière noire Blacklight



W	⚡	∅ mm	⇅ mm	lm	↗	K	⌚	EAN	📦
75	E27	55	95				1.000	4000870 590706	590.70

- |  |   |   |
|--|---|---|
| <ul style="list-style-type: none"> <li>▶ Infrarot</li> <li>▶ Nicht für medizinische Anwendungen.</li> <li>▶ Betrieb nur in Leuchten mit Schutzglas zulässig.</li> <li>▶ Nicht für Allgemeinbeleuchtung, nur für Spezialanwendung!</li> </ul> | <ul style="list-style-type: none"> <li>▶ Infrarouge</li> <li>▶ Ne convient pas aux applications médicales.</li> <li>▶ Fonctionnement autorisé uniquement dans les luminaires avec verre de protection.</li> <li>▶ Ne convient pas à l'éclairage des pièces de vie, uniquement pour applications spécifiques!</li> </ul> | <ul style="list-style-type: none"> <li>▶ Infrarood</li> <li>▶ Niet voor medische toepassingen.</li> <li>▶ Gebruik alleen in armaturen met beveiligingsglas toegestaan.</li> <li>▶ Niet voor algemene verlichting, alleen voor speciale toepassingen!</li> </ul> |
|--|---|---|



R80 Infrared

R95 Infrared

🔗 Rot Rouge Rood



W	⚡	∅ mm	⇅ mm	lm	↗	K	⌚	EAN	📦
60	E27	80	115	26	80	1.500	1.000	4000870 829776	829.77

W	⚡	∅ mm	⇅ mm	lm	↗	K	⌚	EAN	📦
100	E27	95	134	64	80	1.500	1.000	4000870 829660	829.66

🔗 300° Klar 300° Clair 300° Helder



W	⚡	∅ mm	⇅ mm	lm	↗	K	⌚	EAN	📦
15	E14	22	50	85		2.300	1.000	4000870 820100	820.10

25	E14	25	55	125		2.200	1.000	4000870 820117	820.11
----	-----	----	----	-----	--	-------	-------	----------------	--------



### Wie hell ist die Lampe?

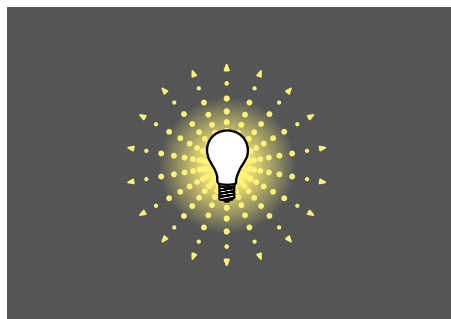

#### Helligkeit bei Rundumstrahlern

Die Maßeinheit Lumen (lm) gibt mit dem Lichtstrom die gesamte Lichtmenge an, die eine rundumstrahlende Lampe abgibt.

### Quelle est la clarté de l'ampoule ?

#### Luminosité d'un éclairage diffus

Le Lumen (lm) est l'unité de mesure du flux lumineux émanant d'une lampe éclairant à 360°.

### Hoe sterk is de lamp?

#### Helderheid bij rondomspots

De eenheid lumen (lm) geeft met de lichtstroom de totale lichthoeveelheid aan die een stralende lamp afgeeft.

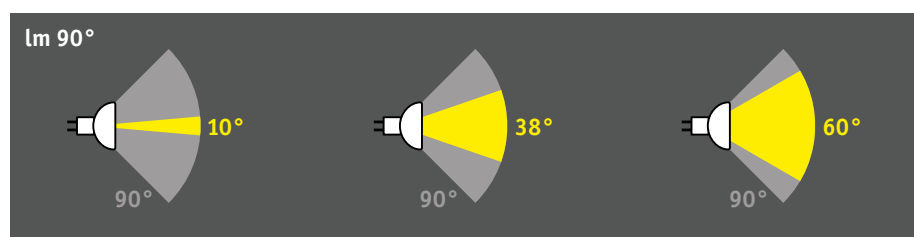

#### Helligkeit bei Reflektorlampen

Alle Reflektorlampen mit einem Ausstrahlwinkel bis max. 90° sind mit Lichtstrom im 90°-Winkel ausgezeichnet und sind somit vergleichbar. Es wird die Helligkeit innerhalb des 90°-Winkels gemessen, auch wenn der tatsächliche Ausstrahlwinkel kleiner ist.

Alle Reflektorlampen mit einem Ausstrahlwinkel von 91° bis max. 120° sind mit dem Wert Lichtstrom im 120°-Winkel ausgezeichnet. Diese Leuchtmittel sind nicht für Akzentbeleuchtung geeignet.

Alle Leuchtmittel mit einem größeren Ausstrahlwinkel als 120° gelten als „nicht gerichtetes Licht“ und werden mit dem Wert Lichtstrom (Lumen, lm) ausgezeichnet, der in den kompletten 360° um das Leuchtmittel herum ermittelt wird.

Die verschiedenen Maßeinheiten Lumen (lm), Lumen im 90°-Winkel (lm90°) und Lumen im 120°-Winkel (lm120°) sind nicht miteinander vergleichbar.

#### Luminosité d'un réflecteur

Tous les réflecteurs avec un faisceau lumineux de max. 90° se voient attribuer un flux lumineux mesuré dans un angle de 90° permettant ainsi la comparaison entre les produits. La mesure de la luminosité est réalisée dans un angle de 90°, même si le faisceau effectif du produit est inférieur.

Tous les réflecteurs avec un faisceau lumineux compris entre 91° et 120° se voient attribuer un flux lumineux mesuré dans un angle de 120°. Ces sources lumineuses ne sont pas adaptées pour un éclairage d'accentuation.

Tous les réflecteurs avec un faisceau lumineux supérieur 120° sont considérés comme un éclairage non-directionnel et se voient attribuer un flux lumineux (Lumen, lm) mesuré dans un angle de 360° autour de la source.

Les différentes unités de mesures Lumen (lm), Lumen dans un angle de 90° (lm90°) et Lumen dans un angle de 120° (lm120°) ne sont pas comparables entre elles.

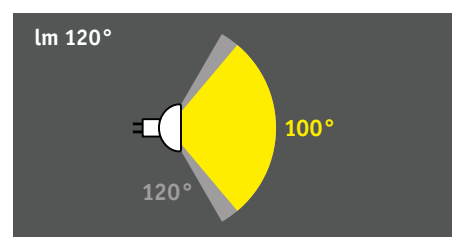

#### Helderheid bij reflectorlampen

Alle reflectorlampen met een uitstraalhoek tot max. 90° zijn gekenmerkt met lichtstroom in 90°-hoek en dus vergelijkbaar. Gemeten wordt de helderheid binnen de 90°-hoek, ook als de werkelijke uitstraalhoek kleiner is.

Alle reflectorlampen met een uitstraalhoek van 91° tot max. 120° zijn gekenmerkt met lichtstroom in 120°-hoek. Deze lampen zijn niet geschikt voor accentverlichting.

Alle lampen met een grotere uitstraalhoek dan 120° gelden als „niet-gericht licht“ en worden met de waarde lichtstroom (lumen, lm) gekenmerkt die in de complete 360° rond de lamp wordt bepaald.

De verschillende maateenheden lumen (lm), lumen in 90°-hoek (lm90°) en lumen in 120°-hoek (lm120°) kunnen niet met elkaar worden vergeleken.

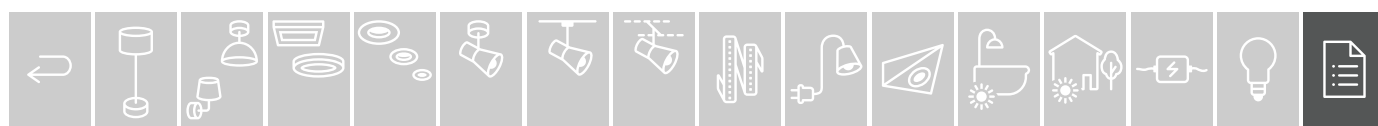







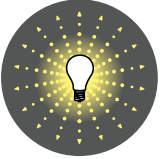

Lumenvergleich

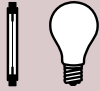
Comparaison des lumens

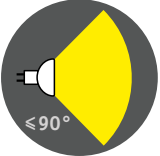
Lumenvergelijking

	Lichttechnik Technologie d'éclairage Lichttechnik	(Glüh-) Lampe Watt Ampoule (à incandescence) Watt (Gloeilamp watt)	LED Helligkeit in Lumen Luminosité LED en lumens LED-helderheid in lumen
<p>Rundumstrahler Omnidirectionnels Rondomstralers</p> 	<p>Glühlampe Klassik Ampoule à incandescence classique Gloeilamp klassiek</p> <p><b>E14, E27, GU10</b></p> 	15 W	140 lm
		25 W	250 lm
		40 W	470 lm
		60 W	806 lm
		75 W	1055 lm
		100 W	1521 lm
	<p>Halogen 230V</p> <p><b>G9, E27, R7s</b></p> 	25 W	250 lm
		40 W	470 lm
		60 W	806 lm
	<p>Halogen 12V</p>  <p><b>G4, GY6,35</b></p>	5 W	45 lm
		10 W	90 lm
		20 W	190 lm
		35 W	390 lm
		50 W	630 lm
	<p>Reflektorlampen Lampes à réflecteur Reflectorlampen</p> 	<p>Halogen 230V</p>  <p><b>E14, E27, GU10</b></p>	25 W
35 W			200 lm
50 W			300 lm
<p>Halogen 12V</p>  <p><b>GU4, GU5,3</b></p>		10 W	80 lm / 90 lm (GU4 / GU5,3)
		20 W	160 lm / 180 lm (GU4 / GU5,3)
		35 W	300 lm
		50 W	540 lm

LED statt Halogen – Austausch bei Hochvolt-Lampen (230 V):

1. Wählen Sie die gewünschte Bauform!
2. Suchen Sie Ihre Fassung aus!
3. Soll die Lampe dimmbar sein?
4. Wählen Sie die gewünschte Helligkeit (Watt/Lumen). Berücksichtigen Sie bitte hierbei die Mindestlast bei Trafos.
5. Welche Lichtfarbe soll die Lampe haben?

LED contre halogène – Substitution en cas d'ampoules haute tension (230 V) :

1. Choisissez le modèle souhaité
2. Trouvez le bon culot
3. La lampe doit-elle être gradable ?
4. Choisissez la luminosité souhaitée (watt/lumen). Veuillez bien tenir compte dans ce cas de la charge minimale des transformateurs.
5. Quelle température de couleur devrait avoir la lampe ?

LED in plaats van halogeen – vervanging van hoogspanningslampen (230 V):

1. Kies de gewenste bouwvorm!
2. Zoek uw fitting uit!
3. Moet de lamp dimbaar zijn?
4. Kies de gewenste helderheid (Watt/Lumen). Houd hierbij rekening met de minimumlast bij trafo's.
5. Welke lichtkleur moet de lamp hebben?

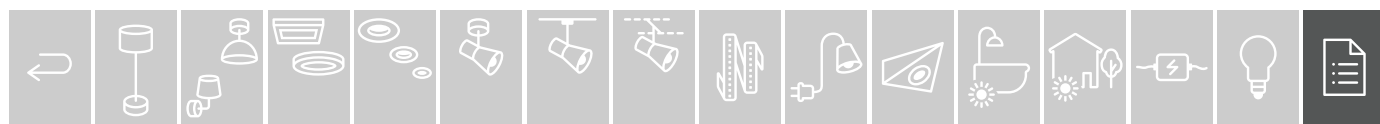



**Dimmable**  
Stufenloses Dimmen ohne  
Änderung der Lichtfarbe.\*

**Dimmable**  
Intensité variable en continu  
sans changement de la  
couleur de feu.\*

**Dimmable**  
Traploos dimmen zonder  
verandering van de  
lichtkleur.\*



**Dim to warm**  
Vom hellen Warmweiß  
zum gedimmten Goldlicht:  
Stufenloses Dimmen bei  
gleichzeitiger Veränderung  
der Farbtemperatur.\*

**Dim to warm**  
Du blanc chaud clair à la  
lumière dorée gradée : Vari-  
ation d'intensité en continu  
avec changement simultané  
de la température de couleur  
en K.\*

**Dim to warm**  
Van helder warmwit tot  
gedimd goudlicht: traploos  
dimmen bij gelijktijdige  
verandering van de  
kleurtemperatuur.\*

\*Für die Auswahl des Dimmers  
beachten Sie bitte unsere Hinweise  
zu den Artikeln auf unserer Website  
unter [www.paulmann.com](http://www.paulmann.com)

\*Pour la sélection du variateur,  
veuillez tenir compte des articles  
présentés sur notre site web [www.paulmann.com](http://www.paulmann.com)

\*Let bij het selecteren van de dimmer  
op de aanwijzingen bij de artikelen  
op onze website [www.paulmann.com](http://www.paulmann.com).

Dimmen über  
konventionellen  
Wandschalter ohne  
separaten Dimmer

Varié l'intensité par  
des commutateurs  
muraux sans variateur  
séparé

Dimmen via  
conventionele  
wandschakelaar zonder  
aparte dimmer



**3 Step dim**  
In 3 Stufen dimmen durch  
mehrmaliges Betätigen  
des vorhandenen  
handelsüblichen  
Lichtschalters.

**3 Step dim**  
Varié l'intensité sur  
3 niveaux par actionnement  
multiple de l'interrupteur  
ordinaire déjà présent.

**3 Step dim**  
In 3 standen dimmen door  
meerdere keren te drukken  
op de bestaande, standaard  
lichtschakelaar.



**Easydim**  
Kurzes Aus-Ein-Schalten  
mit dem vorhandenen  
handelsüblichen  
Lichtschalter startet und  
stoppt den stufenlosen  
Dimmvorgang.

**Easydim**  
Une commutation courte  
actionne et éteint le  
processus de variation de  
l'intensité en continu avec  
l'interrupteur classique  
existant.

**Easydim**  
Kort uit- en inschakelen met  
de bestaande, standaard  
lichtschakelaar start en stopt  
het traploze dimproces.



**3 Step dim to warm**  
Vom hellen Warmweiß zum  
gedimmten Goldlicht: In  
drei Stufen dimmen und  
gleichzeitig Farbtemperatur  
verändern durch mehrmaliges  
Betätigen des vorhandenen  
handelsüblichen  
Lichtschalters.

**3 Step dim to warm**  
Du blanc chaud clair à la  
lumière dorée gradée : Varié  
l'intensité sur trois niveaux  
et changer en même temps  
la température de couleur  
en K par un actionnement  
multiple de l'interrupteur  
ordinaire à disposition.

**3 Step dim to warm**  
Van helder warmwit tot  
gedimd goudlicht: in  
drie stappen dimmen  
en tegelijkertijd de  
kleurtemperatuur veranderen  
door meerdere keren op  
de bestaande, standaard  
lichtschakelaar te drukken.

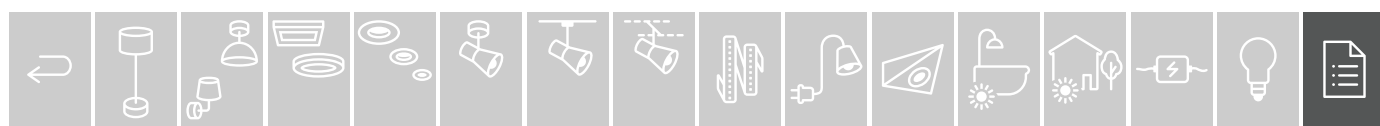

Gewünschte Lichtfarbe?

Température de couleur souhaitée ?

Gewenste lichtkleur?



**extra warm white**  
1500–2700 K



**Extra warmweißes Licht** oder Goldlicht ist rötliche, wirkt wie Kerzenlicht und ist extrem gemütlich!

**L'éclairage blanc chaud extra** ou la lumière dorée est rougeâtre, fait l'effet d'un éclairage à la bougie et s'avère des plus agréables !

**Extra warmwit licht** of goudlicht is roodachtig, heeft het effect van kaarslicht en is bijzonder gezellig!



**warm white**  
2700–3300 K



**Warmweißes Licht** ähnelt dem natürlichen Licht während eines Sonnenuntergangs und hat eine entspannende Wirkung auf uns.

**L'éclairage blanc chaud** ressemble à la lumière naturelle du coucher du soleil et nous apaise.

**Warmwit licht** lijkt op natuurlijk licht tijdens een zonsondergang en heeft een ontspannend effect op ons.



**neutral white**  
3300–5300 K



**Neutralweißes Licht** sorgt für eine „sachliche“ Beleuchtung, gut geeignet in der Küche oder auch im Bad.

**L'éclairage blanc neutre** veille à un éclairage « fonctionnel » qui convient bien dans la cuisine ou la salle de bain.

**Neutraal wit licht** zorgt voor een 'zakelijke' verlichting en is uitstekend geschikt voor in de keuken of badkamer.



**daylight**  
≥ 5300 K



**Tageslichtweißes Licht** entspricht dem Tageslicht während der Mittagszeit. Licht mit höherem Blauanteil wirkt aktivierend und fördert die Konzentration. Ideal zur Beleuchtung von Arbeitsbereichen

**L'éclairage blanc lumière du jour** correspond à la lumière du jour aux heures du déjeuner. La lumière à forte proportion de bleu a un effet activant et favorise la concentration. Idéal pour l'éclairage et les espaces de travail

**Daglichtwit licht** komt overeen met het daglicht tijdens de middag. Licht met een hoger blauwgehalte heeft een activerend effect en bevordert de concentratie. Ideaal voor de verlichting van werkplekken



**Tunable White:** Stufenlose Auswahl der weißen Lichtfarbe und Helligkeit im Bereich von Warmweiß bis Tageslichtweiß.

**Tunable White :** Sélection continue de la couleur de feu blanche et de la luminosité dans les tons blanc chaud à blanc lumière du jour.

**Tunable White:** Traploze keuze van de witte lichtkleur (van warmwit tot daglichtwit) en de helderheid.



**White switch:** Auswahl von drei Weißtönen (Warmweiß, Neutralweiß oder Tageslichtweiß) durch mehrmaliges Betätigen des vorhandenen handelsüblichen Lichtschalters.

**White switch :** Sélection entre trois tonalités de blanc (blanc chaud, blanc neutre ou blanc lumière du jour) par actionnement multiple de l'interrupteur habituel à disposition.

**White switch:** Keuze uit drie tinten wit (warmwit, neutraal wit of daglichtwit), door meerdere keren te drukken op de bestaande standaard lichtschakelaar.

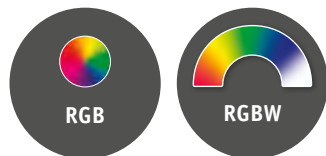

**RGB:** Stufenlose Auswahl aus 16 Mio. Farbtönen,

**RGB :** Sélection continue parmi 16 millions de couleurs.

**RGB:** Traploze keuze uit 16 miljoen kleurnuances,

**RGBW:** zusätzlich mit echtem Warmweiß, stufenlos dimmbar.

**RGBW :** avec en plus blanc chaud authentique, gradable en continu.

**RGBW:** met extra echt warmwit, traploos dimbaar.



**RGB Rainbow:** Dynamische Lichteffecte in Regenbogen-Farben

**RGB Rainbow :** effets lumineux dynamiques dans les couleurs de l'arc-en-ciel

**RGB Rainbow:** Dynamische lichteffecten in regenboogkleuren





### Trafo für LED: die Universallösung

Sollten die neuen LED-Lampen nicht die Mindestlast des Trafos erreichen, empfehlen wir einen neuen elektronischen Trafo, der die Leistung von 0-40 Watt (bei LED) aufnimmt. Art-Nr. 977.67

### Transformateur pour LED : la solution universelle

Si les nouvelles lampes LED n'atteignent pas la charge minimale du transformateur, nous vous en recommandons un nouveau, électronique qui accepte une charge variant de 0 à 40W (dans le cas de LED). N° d'article 977.67

### Trafo voor LED: de universele oplossing

Als de nieuwe LED-lampen de minimumlast van de trafo niet dienen te bereiken, dan adviseren wij een nieuwe elektronische trafo te gebruiken, die het vermogen van 0-40 W (bij LED) opneemt. Art-nr. 977.67



### Dimmerkennzeichnung

Leuchten, die ohne Leuchtmittel und gegebenenfalls ohne Vorschaltgerät ausgeliefert werden, sind deklariert mit z.B. „max. 40W“. Sind diese Leuchten dimmbar, sind sie deklariert mit

Die Dimmbarkeit ist jedoch abhängig von der Art der verwendeten Leuchtmittel und gegebenenfalls des Vorschaltgeräts. Hier finden Sie weiterführende Informationen: [www.paulmann.com/productdata](http://www.paulmann.com/productdata)

In einer Installation muss der richtige Dimmer zur richtigen Lampe bzw. Leuchte passen.

Die Kennzeichen (**R, L, C, LED...**) oder deren Kombinationen definieren Dimmer, Trafos und Lampen.

Für die richtige Auswahl des Dimmers müssen die entsprechenden Kennzeichen auf dem Dimmer, Trafo oder der Lampe übereinstimmen.

Für LED Produkte benötigen Sie einen LED Dimmer der entweder mit dem PhasenANSchnitt- Prinzip



oder PhasenABSchnitt-Prinzip



arbeitet.  
(Kennzeichen **LED, HV-LED, LEDi**)

### Identification variateur

Les luminaires livrés sans ampoules et éventuellement sans ballast portent une mention comme par ex. « max. 40W ». Si ces luminaires sont gradables, ils portent la mention

La variation d'intensité dépend toutefois du type d'ampoules utilisées et, le cas échéant, du ballast. Pour davantage d'informations, rendez-vous à la page [www.paulmann.com/productdata](http://www.paulmann.com/productdata)

Dans une installation, il est important d'adapter le bon variateur à la bonne ou aux bonnes ampoules.

Les désignations (**R, L, C, LED...**) ou leur combinaison définissent les variateurs, les transformateurs et les ampoules.

Pour choisir le bon variateur, les désignations correspondantes sur le variateur, le transformateur et sur l'ampoule doivent correspondre.

Les produits LED requièrent un variateur LED d'intensité fonctionnant sur le principe de découpage de début de phase



ou de découpage de fin de phase



(Désignations **LED, HV-LED, LEDi**)

### Dimmer kenmerking

Armaturen, die zonder verlichtingsmiddel en eventueel zonder voorschakelapparaat geleverd worden, zijn aangeduid met bv. „max. 40W“. Indien deze armaturen dimbaar zijn, worden ze aangeduid met

De dimbaarheid is echter afhankelijk van het gebruikte verlichtingsmiddel en eventueel van het voorschakelapparaat Meer informatie vindt u hier: [www.paulmann.com/productdata](http://www.paulmann.com/productdata)

In een installatie moet de juiste dimmer bij de juiste lamp of armatuur passen.

De merktekens (**R, L, C, LED...**) of combinaties daarvan definiëren dimmer, trafo's en lampen.

Voor de juiste keuze van de dimmer moeten de betreffende merktekens op dimmer, trafo of lamp overeenkomen.

Voor LED-producten hebt u een LED-dimmer nodig die ofwel met het faseaansnijdingsprincipe



of het faseafsnijdingsprincipe



werkt.  
(merktekens **LED, HV-LED, LEDi**)







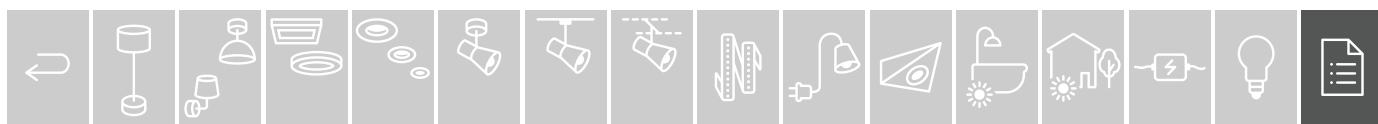
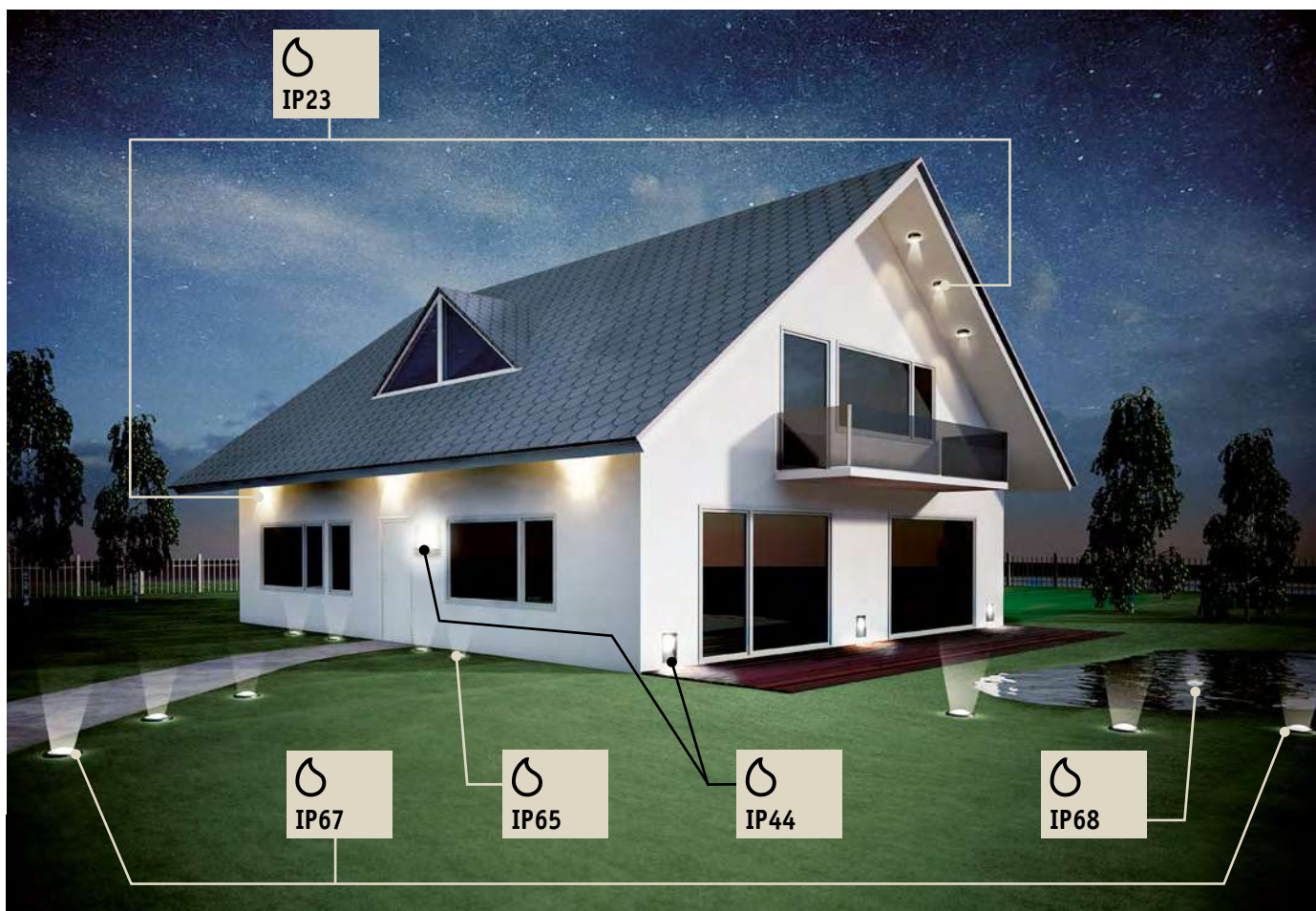

Schutzbereiche

Parties protégées

Beschermde zones



 IP68	Wasserdicht bei dauerhaftem Untertauchen (* und 12V/24 V Schutzkleinspannung)	Protection contre l'immersion permanente (* et 12 V/24 V très basse tension de sécurité)	Waterdicht bij permanente onderdompeling (* en 12 V/24 V beveiliging lage spanning)
 IP67	Wasserdicht bei zeitweiligem Untertauchen (* und 12V/24 V Schutzkleinspannung)	Étanche à l'immersion temporaire (* et 12 V/24 V très basse tension de sécurité)	Waterdicht bij tijdelijke onderdompeling (* en 12 V/24 V beveiliging lage spanning)
 IP65	Strahlwassergeschützt bei direktem Wasserstrahl (* und 12V/24 V Schutzkleinspannung)	Protection contre les jets d'eau directs (* et 12 V/24 V très basse tension de sécurité)	Beschermtd tegen rechtstreekse waterstralen (* en 12 V/24 V beveiliging lage spanning)
 IP44	Spritzwassergeschützt	Protection contre les projections d'eau	Spatwaterdicht
 IP23	Sprühwassergeschützt	Protection contre les aspersion d'eau	Regenwaterdicht
 IP...	Die IP Schutzart ist nur bei Deckenmontage gültig.	Classes de protection IP pour tous les appareils électriques.	IP-beveiligingsklassen voor alle elektrische bedrijfsmiddelen.

**Räume mit elektrischen Anlagen nach DIN VDE 0100 T.701 (Bereiche gelten bis Raumhöhe 2,25 m)**

In der Decke dürfen nur Leuchten eingebaut werden, die durch eine festangebrachte Glasscheibe abgedeckt sind oder der Betrieb mit Schutzkleinspannung erfolgt.

Die Sicherheitsstromquelle muss außerhalb der markierten Bereiche angeordnet sein und es muss ein Schutz gegen direktes Berühren stromdurchflossener Teile vorhanden sein. Kabel und Leitungen bis 5 cm unter Putz: nur senkrechte Verlegung und Kabeleinführung in die Rückseite der Leuchte.

**Länder außerhalb Deutschlands:** Die exakt einzuhaltenden Maße sowie die Einschätzung der Bereiche muss gemäß nationaler Installationsvorschriften von einer örtlichen Elektrofachkraft vorgenommen werden.

**Pièces contenant des installations électriques conformes à la norme DIN VDE 0100 T.701 (zones valables pour hauteur de plafond 2,25 m)**

Dans le plafond, les éclairages ne doivent être encastrés que s'ils sont recouverts par une vitre en verre bien fixée ou si le fonctionnement s'effectue avec une très basse tension de sécurité.

La source de courant de sécurité doit se trouver en dehors des zones marquées et il doit y avoir une protection contre le contact direct des parties traversées par le courant. Câbles et fils encastrés jusqu'à 5 cm de profondeur : uniquement pose verticale et passage de câbles dans le dos de la lampe.

**Pays autres que l'Allemagne :** Les dimensions à respecter et l'évaluation des zones doivent être réalisées par un électricien local dans le respect des normes d'installation nationales.

**Ruimtes met elektrische installaties conform DIN VDE 0100 T.701 (bereiken gelden tot ruimtehoogte 2,25 m)**

In het plafond mogen alleen lampen worden ingebouwd die door vast aangebracht glas zijn afgedekt of met beveiligde lage spanning worden gebruikt.

De veiligheidsstrombron moet buiten de gekenmerkte bereiken zijn gemonteerd en er moet een beveiliging tegen direct aanraken van stroom-geleidende delen voorhanden zijn. Kabels en leidingen tot 5 cm ingebouwd: alleen verticale montage en kabelinvoer in de achterzijde van de lamp.

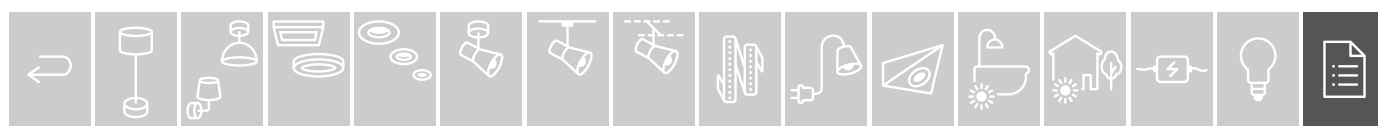

**Landen buiten Duitsland:** Een lokale elektricien dient de exact na te leven maten te bepalen en de bereiken in te schatten volgens de nationale installatierichtlijnen.

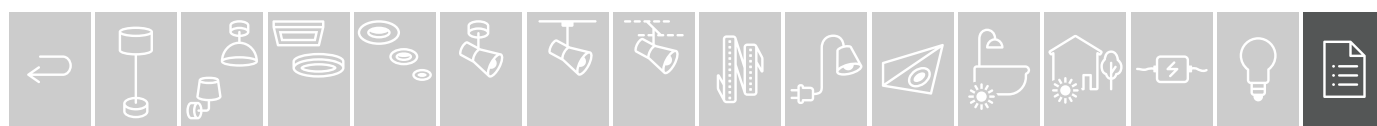

	☐		☐
AR 111 . . . . .	398	Blacklight . . . . .	437
Aari . . . . .	59	Bodeminbouwlampen . . . . .	.325, 327–328, 331–332, 334, 358–360, 381
Abhängung. . . . .	178, 210	Bodeneinbauleuchten. . . . .	.325, 327–328, 331–332, 334, 358–360, 381
Abia . . . . .	86	Calla. . . . .	.108–109
Ace. . . . .	298	Calotte . . . . .	.416–419
Adaptateur. . . . .	142	Cameo. . . . .	293
Adapter E27-GU10 . . . . .	.401, 435	Cardan . . . . .	.189, 205
Adapter. . . . .	142	Choose . . . . .	107
Agena . . . . .	285	Circlips . . . . .	143
Aldan . . . . .	47	Clear. . . . .	203
Alimentation électrique . . . . .	.180, 211	Clever Connect . . . . .	.284, 289
Ampoule infrarouge . . . . .	437	Coin . . . . .	96–97, 101–102, 107, 117–118
Anneau . . . . .	419	Colmar . . . . .	207
Ardora. . . . .	62	Colorflex . . . . .	264
Argun . . . . .	63	Comet . . . . .	207
Atria. . . . .	82	Connecteur . . . . .	179, 286–287
Aufbauleuchte . . . . .	.291–293	Corduo . . . . .	201
Aviar. . . . .	87	Cosylight. . . . .	437
Backofen . . . . .	437	Couvercle encastré. . . . .	142
Badkamerlamp . . . . .	.71, 304–319	Cover . . . . .	345
Badleuchte. . . . .	.71, 304–319	Cup . . . . .	191
Bakoven . . . . .	437	Cymbal . . . . .	121
Base . . . . .	91, 111	Câble de tension . . . . .	210
Basic system. . . . .	201	Delta Profil . . . . .	255
Basic . . . . .	208	Dilja . . . . .	.24
Beam Fifty . . . . .	.278–279	Disc . . . . .	197
Beam Sixty. . . . .	.278–279	Distributeur . . . . .	342
Beam Thirty . . . . .	.278–279	Douille GZ10 pour ampoules GU/GZ10 . . . . .	.401, 435
Belaja . . . . .	51	Douille . . . . .	143







			
Duo Profil . . . . .	253	Hausnummer . . . . .	375
Edge . . . . .	140	Huisnummer . . . . .	375
Edla . . . . .	27	Iben . . . . .	27
Einbautopf . . . . .	142	Inbouwpot . . . . .	142
Einspeisung . . . . .	180, 211	Infrarood . . . . .	437
Elia . . . . .	27	Infraroodlamp . . . . .	437
Encastrés sol . . . . .	325, 327–328, 331–332, 334, 358–360, 381	Infrarot . . . . .	437
Erdspieß . . . . .	330, 377	Infrarotlampe . . . . .	437
Esben . . . . .	25	Infrarouge . . . . .	437
Fassung . . . . .	143	Innershape . . . . .	421
Filament . . . . .	405–411, 425	Jiggle . . . . .	302
Finja . . . . .	273	Juwel . . . . .	398
Fitting . . . . .	143	Kabelblok . . . . .	211
FixedLED . . . . .	110	Kit de traction . . . . .	210
Flackerkerze . . . . .	437	Klemmspot . . . . .	272
Flakkerkaars . . . . .	437	Klemspot . . . . .	272
Flamme scintillante . . . . .	437	Klipp Klapp . . . . .	296
FlexLED . . . . .	245	Koelkast . . . . .	403
Floor Profil 1m . . . . .	256	Kogellampen . . . . .	408
Four . . . . .	437	Kopfspiegel . . . . .	416–419
Frame . . . . .	145	Kopfspiegel . . . . .	416–419
Frigo . . . . .	403	Kura . . . . .	24
Galeria . . . . .	287	Kühlschrank . . . . .	403
Garden Spot . . . . .	363	Lampes en forme de goutte . . . . .	408
Gesa . . . . .	273	Leaf . . . . .	290
Globe . . . . .	293	Leeslamp . . . . .	287
Grondpen . . . . .	330, 377	Leonis . . . . .	280
Gutta . . . . .	54	Leseleuchte . . . . .	287
Halo+ . . . . .	435	Liao . . . . .	62

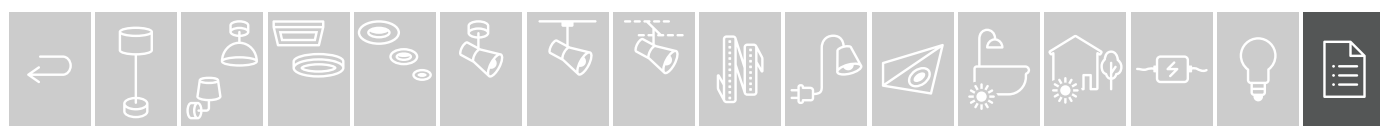

	☐		☐
Linja . . . . .	25	Pia . . . . .	58
Liseuse . . . . .	287	Pinja . . . . .	59
Luminaire de salle de bains . . . . .	71, 304 –319	Piquet à planter . . . . .	330, 377
Luminaire en saillie . . . . .	291–293	Plantengroei . . . . .	432
Luminaire de miroir . . . . .	287, 289	Plattern . . . . .	292
Lumière noire . . . . .	437	Plaza . . . . .	270
Lunar . . . . .	85	Pousse-plantes . . . . .	432
Mac II . . . . .	205	Profiel . . . . .	259–261, 263
Mac . . . . .	195–196	Profil . . . . .	259–261, 263
Mari . . . . .	64	Profilé . . . . .	259–261, 263
MaxLED . . . . .	217–221, 224, 226, 228	Promo Panel . . . . .	133
Maxiflood . . . . .	398	QPAR 111 . . . . .	402
Meli . . . . .	148	Rail . . . . .	178
Menja . . . . .	25	Rainbow . . . . .	61
Mobil Strip . . . . .	267	Ramos . . . . .	52
Nachtlicht . . . . .	271	Renvoi d'angle . . . . .	210
Narve . . . . .	26	Ringspiegel . . . . .	419
Noora . . . . .	58	Rotate . . . . .	302–303
Nova . . . . .	93–96, 98, 100, 104, 118	Runa . . . . .	18
Numéro de maison . . . . .	375	Sabik . . . . .	53, 284
Ombuiger . . . . .	210	Sabot contact . . . . .	211
Opbouwlamp . . . . .	291–293	Schiene . . . . .	178
Ophanging . . . . .	178, 210	Schwarzlicht . . . . .	437
Outdoor . . . . .	326, 329–332, 338–340, 353–355, 357, 361	Seilklotz . . . . .	211
PIR-Sensor . . . . .	237	Set Cone . . . . .	193
Panel . . . . .	75–77, 136–137	Set Mac II . . . . .	204–205
Park+Light . . . . .	348	Set Sheela . . . . .	206
Pendelleuchten . . . . .	29	SimpLED . . . . .	247–249
Pflanzenwachstum . . . . .	432	Simplo . . . . .	288







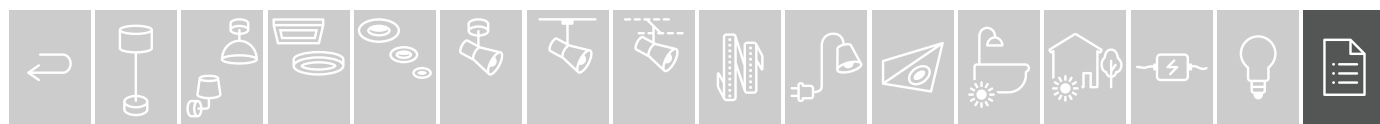

			
SmartHome Downlights . . . . .	103	Trafo . . . . .	225, 389–390
SmartHome Function . . . . .	218, 229, 243–244	Transformateur . . . . .	225, 389–390
SmartHome Living room . . . . .	49, 79	TriX . . . . .	299
SmartHome Outdoor . . . . .	343	Tropfenlampen . . . . .	408
SmartHome Rail Systems . . . . .	183	Tube Profil . . . . .	262
SmartHome Wire Systems . . . . .	186	Tube . . . . .	291, 356
SmartHome . . . . .	10–13	URail . . . . .	172, 174–175, 177–181, 183
SmartLight . . . . .	303	USB-Strips . . . . .	266–267
SnapLED . . . . .	301	Umlenker . . . . .	210
Span-montageset . . . . .	210	Vala . . . . .	25
Spankabel . . . . .	210	Vane . . . . .	291
Spann-Montageset . . . . .	210	VariLine . . . . .	178
Spannseil . . . . .	210	Veerring . . . . .	143
Spice Salt . . . . .	206	Veilleuse . . . . .	271
Spiegellamp . . . . .	287, 289	Verbinder . . . . .	179, 286–287
Spiegelleuchte . . . . .	287, 289	Verbinding . . . . .	179, 286–287
Spot Cone . . . . .	193	Verdeler . . . . .	342
Spot Mac II . . . . .	204	Verloopstuk E27 - GU10 . . . . .	401, 435
Spot à pince . . . . .	272	Verteiler . . . . .	342
Sprengring . . . . .	143	Verve . . . . .	293
Square Profil . . . . .	258	Voeding . . . . .	180, 211
Stage . . . . .	204	WaterLED . . . . .	251
Starter . . . . .	434	Whirl . . . . .	123, 293
Suon . . . . .	122	YourLED ECO . . . . .	230
Support tubes . . . . .	178, 210	YourLED . . . . .	230–231, 233–235, 237–241
Taija . . . . .	374	Zed LED . . . . .	270
Teja . . . . .	149	Zyli . . . . .	290
Tessa . . . . .	57	easyClick2 . . . . .	116
Togo . . . . .	207		



	☐	☐	☐	☐	☐	☐	☐	☐	☐	☐	
<u>127.08</u>	<u>436</u>	<u>284.01</u>	<u>413</u>	<u>286.03</u>	<u>423</u>	<u>286.42</u>	<u>410</u>	<u>286.87</u>	<u>406</u>	<u>287.23</u>	<u>425</u>
<u>128.08</u>	<u>436</u>	<u>284.02</u>	<u>413</u>	<u>286.10</u>	<u>406</u>	<u>286.43</u>	<u>405</u>	<u>286.88</u>	<u>406</u>	<u>287.24</u>	<u>425</u>
<u>178.03</u>	<u>210</u>	<u>284.03</u>	<u>413</u>	<u>286.11</u>	<u>405</u>	<u>286.45</u>	<u>406</u>	<u>286.89</u>	<u>407</u>	<u>287.27</u>	<u>406</u>
<u>178.06</u>	<u>210</u>	<u>284.06</u>	<u>412</u>	<u>286.12</u>	<u>406</u>	<u>286.47</u>	<u>409</u>	<u>286.90</u>	<u>407</u>	<u>287.28</u>	<u>408</u>
<u>178.24</u>	<u>210</u>	<u>284.07</u>	<u>412</u>	<u>286.13</u>	<u>406</u>	<u>286.50</u>	<u>407</u>	<u>286.91</u>	<u>407</u>	<u>287.29</u>	<u>410</u>
<u>178.34</u>	<u>210</u>	<u>284.26</u>	<u>399</u>	<u>286.14</u>	<u>409</u>	<u>286.52</u>	<u>408</u>	<u>286.92</u>	<u>407</u>	<u>287.32</u>	<u>432</u>
<u>179.43</u>	<u>113</u>	<u>284.27</u>	<u>399</u>	<u>286.15</u>	<u>410</u>	<u>286.54</u>	<u>407</u>	<u>286.93</u>	<u>408</u>	<u>287.33</u>	<u>432</u>
<u>179.45</u>	<u>113</u>	<u>284.30</u>	<u>402</u>	<u>286.16</u>	<u>409</u>	<u>286.55</u>	<u>407</u>	<u>286.94</u>	<u>408</u>	<u>287.34</u>	<u>432</u>
<u>179.46</u>	<u>113</u>	<u>284.44</u>	<u>399</u>	<u>286.17</u>	<u>410</u>	<u>286.56</u>	<u>408</u>	<u>286.95</u>	<u>409</u>	<u>287.35</u>	<u>402</u>
<u>179.51</u>	<u>114</u>	<u>285.14</u>	<u>402</u>	<u>286.18</u>	<u>410</u>	<u>286.57</u>	<u>408</u>	<u>286.96</u>	<u>409</u>	<u>287.36</u>	<u>432</u>
<u>179.53</u>	<u>114</u>	<u>285.15</u>	<u>398</u>	<u>286.19</u>	<u>409</u>	<u>286.63</u>	<u>416</u>	<u>286.97</u>	<u>409</u>	<u>287.37</u>	<u>432</u>
<u>179.54</u>	<u>114</u>	<u>285.21</u>	<u>413</u>	<u>286.20</u>	<u>409</u>	<u>286.64</u>	<u>416</u>	<u>286.98</u>	<u>409</u>	<u>287.38</u>	<u>405</u>
<u>179.55</u>	<u>114</u>	<u>285.22</u>	<u>412</u>	<u>286.21</u>	<u>410</u>	<u>286.65</u>	<u>416</u>	<u>286.99</u>	<u>410</u>	<u>287.39</u>	<u>407</u>
<u>180.00</u>	<u>352</u>	<u>285.23</u>	<u>412</u>	<u>286.22</u>	<u>410</u>	<u>286.67</u>	<u>416</u>	<u>287.00</u>	<u>410</u>	<u>287.42</u>	<u>420</u>
<u>180.01</u>	<u>352</u>	<u>285.24</u>	<u>412</u>	<u>286.23</u>	<u>411</u>	<u>286.68</u>	<u>416</u>	<u>287.01</u>	<u>411</u>	<u>287.43</u>	<u>420</u>
<u>180.02</u>	<u>353</u>	<u>285.25</u>	<u>412</u>	<u>286.24</u>	<u>411</u>	<u>286.69</u>	<u>417</u>	<u>287.02</u>	<u>411</u>	<u>287.44</u>	<u>420</u>
<u>180.03</u>	<u>353</u>	<u>285.26</u>	<u>412</u>	<u>286.25</u>	<u>411</u>	<u>286.70</u>	<u>417</u>	<u>287.03</u>	<u>411</u>	<u>287.45</u>	<u>428</u>
<u>180.10</u>	<u>344</u>	<u>285.37</u>	<u>399</u>	<u>286.26</u>	<u>411</u>	<u>286.71</u>	<u>417</u>	<u>287.04</u>	<u>426</u>	<u>287.46</u>	<u>428</u>
<u>180.11</u>	<u>344</u>	<u>285.38</u>	<u>399</u>	<u>286.27</u>	<u>411</u>	<u>286.72</u>	<u>417</u>	<u>287.05</u>	<u>426</u>	<u>287.47</u>	<u>428</u>
<u>180.12</u>	<u>343</u>	<u>285.70</u>	<u>409</u>	<u>286.28</u>	<u>411</u>	<u>286.73</u>	<u>417</u>	<u>287.06</u>	<u>426</u>	<u>287.50</u>	<u>428</u>
<u>216</u>	<u>143</u>	<u>285.71</u>	<u>409</u>	<u>286.29</u>	<u>408</u>	<u>286.74</u>	<u>417</u>	<u>287.07</u>	<u>426</u>	<u>287.51</u>	<u>401</u>
<u>217</u>	<u>143</u>	<u>285.72</u>	<u>405</u>	<u>286.30</u>	<u>407</u>	<u>286.75</u>	<u>418</u>	<u>287.08</u>	<u>426</u>	<u>287.52</u>	<u>401</u>
<u>218.9</u>	<u>143</u>	<u>285.73</u>	<u>407</u>	<u>286.31</u>	<u>408</u>	<u>286.76</u>	<u>418</u>	<u>287.09</u>	<u>426</u>	<u>287.53</u>	<u>401</u>
<u>232</u>	<u>364</u>	<u>285.77</u>	<u>402</u>	<u>286.32</u>	<u>408</u>	<u>286.77</u>	<u>418</u>	<u>287.10</u>	<u>427</u>	<u>287.54</u>	<u>401</u>
<u>233</u>	<u>143</u>	<u>285.78</u>	<u>399</u>	<u>286.33</u>	<u>407</u>	<u>286.78</u>	<u>418</u>	<u>287.11</u>	<u>427</u>	<u>287.55</u>	<u>401</u>
<u>236</u>	<u>142</u>	<u>285.79</u>	<u>399</u>	<u>286.34</u>	<u>408</u>	<u>286.79</u>	<u>419</u>	<u>287.12</u>	<u>427</u>	<u>287.56</u>	<u>401</u>
<u>237</u>	<u>364</u>	<u>285.80</u>	<u>399</u>	<u>286.35</u>	<u>408</u>	<u>286.80</u>	<u>419</u>	<u>287.13</u>	<u>427</u>	<u>287.57</u>	<u>398</u>
<u>281.10</u>	<u>403</u>	<u>285.81</u>	<u>402</u>	<u>286.36</u>	<u>406</u>	<u>286.81</u>	<u>419</u>	<u>287.14</u>	<u>427</u>	<u>287.58</u>	<u>398</u>
<u>281.11</u>	<u>403</u>	<u>285.98</u>	<u>422</u>	<u>286.37</u>	<u>406</u>	<u>286.82</u>	<u>419</u>	<u>287.15</u>	<u>427</u>	<u>287.59</u>	<u>398</u>
<u>283.29</u>	<u>398</u>	<u>285.99</u>	<u>422</u>	<u>286.38</u>	<u>408</u>	<u>286.83</u>	<u>405</u>	<u>287.16</u>	<u>427</u>	<u>287.60</u>	<u>406</u>
<u>283.30</u>	<u>398</u>	<u>286.00</u>	<u>423</u>	<u>286.39</u>	<u>408</u>	<u>286.84</u>	<u>405</u>	<u>287.17</u>	<u>427</u>	<u>287.61</u>	<u>408</u>
<u>283.99</u>	<u>413</u>	<u>286.01</u>	<u>423</u>	<u>286.40</u>	<u>407</u>	<u>286.85</u>	<u>406</u>	<u>287.21</u>	<u>425</u>	<u>287.62</u>	<u>410</u>
<u>284.00</u>	<u>413</u>	<u>286.02</u>	<u>423</u>	<u>286.41</u>	<u>409</u>	<u>286.86</u>	<u>406</u>	<u>287.22</u>	<u>425</u>	<u>287.63</u>	<u>421</u>







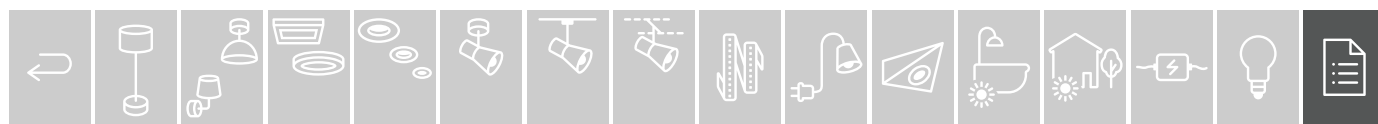



											
<u>667.54</u>	<u>146</u>	<u>702.62</u>	<u>255</u>	<u>704.41</u>	<u>257</u>	<u>705.44</u>	<u>61</u>	<u>705.94</u>	<u>231</u>	<u>706.50</u>	<u>85</u>
<u>667.55</u>	<u>147</u>	<u>702.63</u>	<u>255</u>	<u>704.42</u>	<u>257</u>	<u>705.45</u>	<u>61</u>	<u>705.99</u>	<u>240</u>	<u>706.51</u>	<u>85</u>
<u>667.56</u>	<u>147</u>	<u>702.64</u>	<u>255</u>	<u>704.51</u>	<u>391</u>	<u>705.46</u>	<u>61</u>	<u>706.04</u>	<u>218</u>	<u>706.52</u>	<u>85</u>
<u>667.57</u>	<u>147</u>	<u>702.65</u>	<u>255</u>	<u>704.51</u>	<u>237</u>	<u>705.47</u>	<u>61</u>	<u>706.05</u>	<u>218</u>	<u>706.53</u>	<u>85</u>
<u>667.58</u>	<u>147</u>	<u>702.66</u>	<u>255</u>	<u>704.51</u>	<u>391</u>	<u>705.48</u>	<u>219</u>	<u>706.06</u>	<u>300</u>	<u>706.54</u>	<u>85</u>
<u>667.59</u>	<u>148</u>	<u>702.67</u>	<u>253</u>	<u>704.51</u>	<u>237</u>	<u>705.49</u>	<u>219</u>	<u>706.12</u>	<u>300</u>	<u>706.55</u>	<u>85</u>
<u>667.60</u>	<u>148</u>	<u>702.68</u>	<u>253</u>	<u>704.53</u>	<u>253</u>	<u>705.50</u>	<u>219</u>	<u>706.13</u>	<u>300</u>	<u>706.56</u>	<u>85</u>
<u>667.61</u>	<u>148</u>	<u>702.69</u>	<u>253</u>	<u>704.55</u>	<u>266</u>	<u>705.51</u>	<u>219</u>	<u>706.14</u>	<u>300</u>	<u>706.63</u>	<u>219</u>
<u>667.62</u>	<u>148</u>	<u>702.70</u>	<u>253</u>	<u>704.56</u>	<u>266</u>	<u>705.57</u>	<u>264</u>	<u>706.15</u>	<u>224</u>	<u>706.64</u>	<u>219</u>
<u>667.63</u>	<u>146</u>	<u>702.72</u>	<u>253</u>	<u>704.58</u>	<u>230</u>	<u>705.58</u>	<u>264</u>	<u>706.16</u>	<u>224</u>	<u>706.65</u>	<u>219</u>
<u>667.64</u>	<u>146</u>	<u>702.74</u>	<u>253</u>	<u>704.59</u>	<u>230</u>	<u>705.59</u>	<u>262</u>	<u>706.17</u>	<u>224</u>	<u>706.66</u>	<u>219</u>
<u>667.65</u>	<u>146</u>	<u>702.75</u>	<u>253</u>	<u>704.60</u>	<u>230</u>	<u>705.60</u>	<u>262</u>	<u>706.18</u>	<u>224</u>	<u>706.67</u>	<u>219</u>
<u>701.74</u>	<u>153</u>	<u>702.82</u>	<u>240</u>	<u>704.61</u>	<u>235</u>	<u>705.61</u>	<u>264</u>	<u>706.19</u>	<u>228</u>	<u>706.68</u>	<u>219</u>
<u>701.99</u>	<u>236</u>	<u>703.17</u>	<u>231</u>	<u>704.63</u>	<u>309</u>	<u>705.62</u>	<u>264</u>	<u>706.23</u>	<u>219</u>	<u>706.69</u>	<u>221</u>
<u>702.00</u>	<u>236</u>	<u>703.18</u>	<u>231</u>	<u>704.64</u>	<u>309</u>	<u>705.63</u>	<u>264</u>	<u>706.24</u>	<u>219</u>	<u>706.70</u>	<u>221</u>
<u>702.01</u>	<u>236</u>	<u>703.19</u>	<u>231</u>	<u>704.68</u>	<u>313</u>	<u>705.64</u>	<u>264</u>	<u>706.27</u>	<u>219</u>	<u>706.71</u>	<u>221</u>
<u>702.02</u>	<u>234</u>	<u>703.20</u>	<u>231</u>	<u>704.70</u>	<u>311</u>	<u>705.68</u>	<u>221</u>	<u>706.28</u>	<u>219</u>	<u>706.72</u>	<u>221</u>
<u>702.03</u>	<u>240</u>	<u>703.21</u>	<u>231</u>	<u>704.80</u>	<u>246</u>	<u>705.69</u>	<u>221</u>	<u>706.30</u>	<u>219</u>	<u>706.75</u>	<u>221</u>
<u>702.04</u>	<u>240</u>	<u>703.22</u>	<u>231</u>	<u>704.81</u>	<u>246</u>	<u>705.74</u>	<u>224</u>	<u>706.34</u>	<u>219</u>	<u>706.76</u>	<u>221</u>
<u>702.08</u>	<u>231</u>	<u>703.34</u>	<u>241</u>	<u>704.86</u>	<u>241</u>	<u>705.75</u>	<u>224</u>	<u>706.35</u>	<u>302</u>	<u>706.83</u>	<u>228</u>
<u>702.09</u>	<u>231</u>	<u>703.50</u>	<u>309</u>	<u>704.88</u>	<u>241</u>	<u>705.76</u>	<u>224</u>	<u>706.36</u>	<u>302</u>	<u>706.96</u>	<u>246</u>
<u>702.10</u>	<u>231</u>	<u>703.54</u>	<u>308</u>	<u>704.89</u>	<u>241</u>	<u>705.77</u>	<u>218</u>	<u>706.37</u>	<u>303</u>	<u>706.97</u>	<u>246</u>
<u>702.15</u>	<u>240</u>	<u>703.98</u>	<u>299</u>	<u>704.90</u>	<u>241</u>	<u>705.78</u>	<u>218</u>	<u>706.38</u>	<u>303</u>	<u>707.00</u>	<u>267</u>
<u>702.21</u>	<u>253</u>	<u>704.09</u>	<u>256</u>	<u>704.98</u>	<u>301</u>	<u>705.79</u>	<u>218</u>	<u>706.39</u>	<u>303</u>	<u>707.01</u>	<u>267</u>
<u>702.45</u>	<u>270</u>	<u>704.10</u>	<u>256</u>	<u>705.10</u>	<u>233</u>	<u>705.80</u>	<u>218</u>	<u>706.41</u>	<u>85</u>	<u>707.02</u>	<u>267</u>
<u>702.51</u>	<u>240</u>	<u>704.17</u>	<u>251</u>	<u>705.13</u>	<u>247</u>	<u>705.81</u>	<u>218</u>	<u>706.42</u>	<u>85</u>	<u>707.05</u>	<u>267</u>
<u>702.52</u>	<u>230</u>	<u>704.18</u>	<u>251</u>	<u>705.14</u>	<u>247</u>	<u>705.82</u>	<u>218</u>	<u>706.43</u>	<u>85</u>	<u>707.06</u>	<u>267</u>
<u>702.53</u>	<u>230</u>	<u>704.19</u>	<u>251</u>	<u>705.15</u>	<u>247</u>	<u>705.85</u>	<u>221</u>	<u>706.44</u>	<u>85</u>	<u>707.22</u>	<u>306</u>
<u>702.54</u>	<u>230</u>	<u>704.28</u>	<u>230</u>	<u>705.16</u>	<u>226</u>	<u>705.86</u>	<u>221</u>	<u>706.45</u>	<u>85</u>	<u>707.24</u>	<u>306</u>
<u>702.55</u>	<u>230</u>	<u>704.29</u>	<u>230</u>	<u>705.17</u>	<u>259</u>	<u>705.88</u>	<u>221</u>	<u>706.46</u>	<u>85</u>	<u>707.26</u>	<u>237</u>
<u>702.56</u>	<u>230</u>	<u>704.30</u>	<u>230</u>	<u>705.18</u>	<u>259</u>	<u>705.89</u>	<u>221</u>	<u>706.47</u>	<u>85</u>	<u>707.27</u>	<u>237</u>
<u>702.57</u>	<u>230</u>	<u>704.39</u>	<u>257</u>	<u>705.19</u>	<u>253</u>	<u>705.92</u>	<u>231</u>	<u>706.48</u>	<u>85</u>	<u>707.76</u>	<u>298</u>
<u>702.61</u>	<u>255</u>	<u>704.40</u>	<u>257</u>	<u>705.20</u>	<u>253</u>	<u>705.93</u>	<u>231</u>	<u>706.49</u>	<u>85</u>	<u>707.77</u>	<u>298</u>







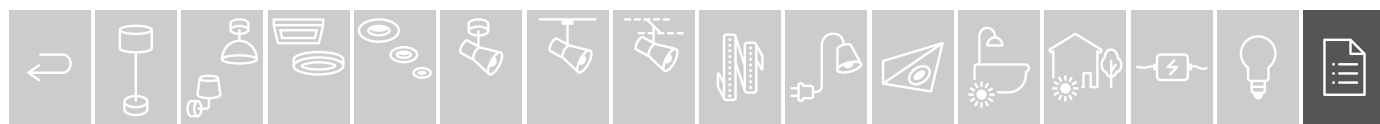









											
<u>796.17</u>	<u>44</u>	<u>796.86</u>	<u>28</u>	<u>797.50</u>	<u>41</u>	<u>798.18</u>	<u>77</u>	<u>798.63</u>	<u>216</u>	<u>800.12</u>	<u>436</u>
<u>796.18</u>	<u>43</u>	<u>796.87</u>	<u>28</u>	<u>797.51</u>	<u>40</u>	<u>798.19</u>	<u>77</u>	<u>798.64</u>	<u>216</u>	<u>800.15</u>	<u>436</u>
<u>796.21</u>	<u>43</u>	<u>796.90</u>	<u>35</u>	<u>797.53</u>	<u>317</u>	<u>798.20</u>	<u>76</u>	<u>798.65</u>	<u>216</u>	<u>800.87</u>	<u>435</u>
<u>796.22</u>	<u>44</u>	<u>796.91</u>	<u>35</u>	<u>797.54</u>	<u>317</u>	<u>798.21</u>	<u>76</u>	<u>798.66</u>	<u>216</u>	<u>800.88</u>	<u>435</u>
<u>796.24</u>	<u>45</u>	<u>796.93</u>	<u>49</u>	<u>797.55</u>	<u>24</u>	<u>798.22</u>	<u>76</u>	<u>798.67</u>	<u>216</u>	<u>800.89</u>	<u>435</u>
<u>796.25</u>	<u>45</u>	<u>796.94</u>	<u>49</u>	<u>797.56</u>	<u>24</u>	<u>798.23</u>	<u>76</u>	<u>798.68</u>	<u>217</u>	<u>800.90</u>	<u>435</u>
<u>796.26</u>	<u>44</u>	<u>797.08</u>	<u>63</u>	<u>797.57</u>	<u>19</u>	<u>798.24</u>	<u>75</u>	<u>798.69</u>	<u>217</u>	<u>800.91</u>	<u>435</u>
<u>796.28</u>	<u>33</u>	<u>797.09</u>	<u>63</u>	<u>797.58</u>	<u>19</u>	<u>798.25</u>	<u>75</u>	<u>798.70</u>	<u>217</u>	<u>820.10</u>	<u>437</u>
<u>796.29</u>	<u>33</u>	<u>797.10</u>	<u>63</u>	<u>797.59</u>	<u>19</u>	<u>798.26</u>	<u>75</u>	<u>798.71</u>	<u>217</u>	<u>820.11</u>	<u>437</u>
<u>796.33</u>	<u>31</u>	<u>797.12</u>	<u>312</u>	<u>797.60</u>	<u>19</u>	<u>798.27</u>	<u>75</u>	<u>798.72</u>	<u>217</u>	<u>829.66</u>	<u>437</u>
<u>796.34</u>	<u>30</u>	<u>797.13</u>	<u>312</u>	<u>797.61</u>	<u>19</u>	<u>798.28</u>	<u>225</u>	<u>798.73</u>	<u>217</u>	<u>829.77</u>	<u>437</u>
<u>796.35</u>	<u>31</u>	<u>797.14</u>	<u>312</u>	<u>797.62</u>	<u>19</u>	<u>798.29</u>	<u>225</u>	<u>798.74</u>	<u>217</u>	<u>831.49</u>	<u>435</u>
<u>796.36</u>	<u>30</u>	<u>797.15</u>	<u>312</u>	<u>797.63</u>	<u>20</u>	<u>798.30</u>	<u>226</u>	<u>798.75</u>	<u>217</u>	<u>831.51</u>	<u>435</u>
<u>796.40</u>	<u>29</u>	<u>797.16</u>	<u>312</u>	<u>797.64</u>	<u>20</u>	<u>798.31</u>	<u>226</u>	<u>798.76</u>	<u>217</u>	<u>831.52</u>	<u>435</u>
<u>796.44</u>	<u>33</u>	<u>797.17</u>	<u>47</u>	<u>797.65</u>	<u>20</u>	<u>798.32</u>	<u>390</u>	<u>798.77</u>	<u>217</u>	<u>831.53</u>	<u>435</u>
<u>796.46</u>	<u>30</u>	<u>797.18</u>	<u>47</u>	<u>797.66</u>	<u>21</u>	<u>798.34</u>	<u>390</u>	<u>798.78</u>	<u>217</u>	<u>831.54</u>	<u>435</u>
<u>796.50</u>	<u>28</u>	<u>797.20</u>	<u>47</u>	<u>797.67</u>	<u>21</u>	<u>798.35</u>	<u>225</u>	<u>798.79</u>	<u>217</u>	<u>831.55</u>	<u>435</u>
<u>796.51</u>	<u>32</u>	<u>797.21</u>	<u>51</u>	<u>797.68</u>	<u>21</u>	<u>798.37</u>	<u>225</u>	<u>798.80</u>	<u>217</u>	<u>884.24</u>	<u>434</u>
<u>796.52</u>	<u>32</u>	<u>797.24</u>	<u>26</u>	<u>797.69</u>	<u>53</u>	<u>798.38</u>	<u>220</u>	<u>798.81</u>	<u>217</u>	<u>884.46</u>	<u>433</u>
<u>796.53</u>	<u>32</u>	<u>797.25</u>	<u>25</u>	<u>797.70</u>	<u>38</u>	<u>798.39</u>	<u>306</u>	<u>798.82</u>	<u>217</u>	<u>884.48</u>	<u>433</u>
<u>796.54</u>	<u>32</u>	<u>797.28</u>	<u>24</u>	<u>797.71</u>	<u>38</u>	<u>798.40</u>	<u>228</u>	<u>798.83</u>	<u>217</u>	<u>884.84</u>	<u>434</u>
<u>796.55</u>	<u>32</u>	<u>797.30</u>	<u>24</u>	<u>797.86</u>	<u>47</u>	<u>798.41</u>	<u>228</u>	<u>798.90</u>	<u>77</u>	<u>885.08</u>	<u>433</u>
<u>796.56</u>	<u>34</u>	<u>797.33</u>	<u>25</u>	<u>797.97</u>	<u>228</u>	<u>798.52</u>	<u>216</u>	<u>798.91</u>	<u>77</u>	<u>885.13</u>	<u>433</u>
<u>796.57</u>	<u>34</u>	<u>797.36</u>	<u>27</u>	<u>798.08</u>	<u>79</u>	<u>798.53</u>	<u>216</u>	<u>798.92</u>	<u>76</u>	<u>885.15</u>	<u>434</u>
<u>796.58</u>	<u>34</u>	<u>797.39</u>	<u>27</u>	<u>798.09</u>	<u>79</u>	<u>798.54</u>	<u>216</u>	<u>798.93</u>	<u>76</u>	<u>885.19</u>	<u>434</u>
<u>796.60</u>	<u>34</u>	<u>797.40</u>	<u>27</u>	<u>798.10</u>	<u>79</u>	<u>798.55</u>	<u>216</u>	<u>798.95</u>	<u>75</u>	<u>885.21</u>	<u>434</u>
<u>796.61</u>	<u>41</u>	<u>797.42</u>	<u>25</u>	<u>798.11</u>	<u>66</u>	<u>798.56</u>	<u>216</u>	<u>798.97</u>	<u>75</u>	<u>885.36</u>	<u>434</u>
<u>796.63</u>	<u>44</u>	<u>797.43</u>	<u>25</u>	<u>798.12</u>	<u>66</u>	<u>798.57</u>	<u>216</u>	<u>798.99</u>	<u>75</u>	<u>885.41</u>	<u>434</u>
<u>796.64</u>	<u>29</u>	<u>797.44</u>	<u>29</u>	<u>798.13</u>	<u>224</u>	<u>798.58</u>	<u>216</u>	<u>799.04</u>	<u>78</u>	<u>885.45</u>	<u>434</u>
<u>796.65</u>	<u>45</u>	<u>797.45</u>	<u>29</u>	<u>798.14</u>	<u>221</u>	<u>798.59</u>	<u>216</u>	<u>799.05</u>	<u>78</u>	<u>885.49</u>	<u>434</u>
<u>796.66</u>	<u>357</u>	<u>797.46</u>	<u>23</u>	<u>798.15</u>	<u>50</u>	<u>798.60</u>	<u>216</u>	<u>799.07</u>	<u>78</u>	<u>885.50</u>	<u>434</u>
<u>796.70</u>	<u>357</u>	<u>797.48</u>	<u>23</u>	<u>798.16</u>	<u>77</u>	<u>798.61</u>	<u>216</u>	<u>799.08</u>	<u>78</u>	<u>885.53</u>	<u>434</u>
<u>796.82</u>	<u>35</u>	<u>797.49</u>	<u>23</u>	<u>798.17</u>	<u>77</u>	<u>798.62</u>	<u>216</u>	<u>800.11</u>	<u>436</u>	<u>885.54</u>	<u>434</u>

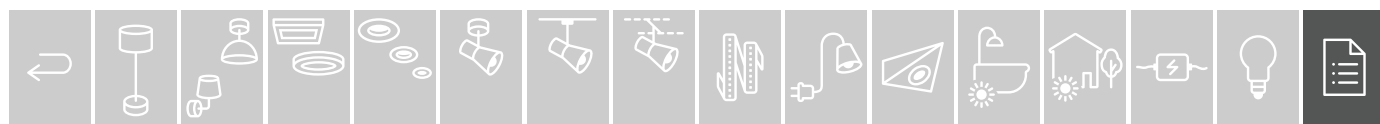







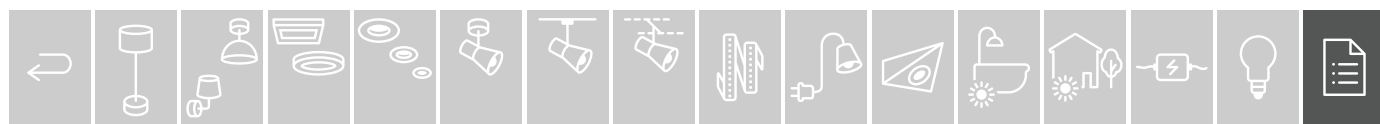

											
<u>885.58</u>	<u>434</u>	<u>923.98</u>	<u>125</u>	<u>929.03</u>	<u>99</u>	<u>929.62</u>	<u>103</u>	<u>930.38</u>	<u>129</u>	<u>930.71</u>	<u>117</u>
<u>885.60</u>	<u>433</u>	<u>924.72</u>	<u>107</u>	<u>929.04</u>	<u>99</u>	<u>929.64</u>	<u>103</u>	<u>930.39</u>	<u>129</u>	<u>930.72</u>	<u>117</u>
<u>885.61</u>	<u>433</u>	<u>924.73</u>	<u>107</u>	<u>929.07</u>	<u>123</u>	<u>929.65</u>	<u>103</u>	<u>930.40</u>	<u>129</u>	<u>930.73</u>	<u>118</u>
<u>885.62</u>	<u>433</u>	<u>924.77</u>	<u>107</u>	<u>929.08</u>	<u>123</u>	<u>929.70</u>	<u>105</u>	<u>930.41</u>	<u>129</u>	<u>930.74</u>	<u>118</u>
<u>885.63</u>	<u>433</u>	<u>924.78</u>	<u>107</u>	<u>929.17</u>	<u>123</u>	<u>929.71</u>	<u>105</u>	<u>930.42</u>	<u>129</u>	<u>930.75</u>	<u>118</u>
<u>920.32</u>	<u>291</u>	<u>924.79</u>	<u>107</u>	<u>929.22</u>	<u>139</u>	<u>929.72</u>	<u>105</u>	<u>930.43</u>	<u>132</u>	<u>930.76</u>	<u>117</u>
<u>920.58</u>	<u>137</u>	<u>924.80</u>	<u>107</u>	<u>929.23</u>	<u>139</u>	<u>929.73</u>	<u>105</u>	<u>930.44</u>	<u>132</u>	<u>930.77</u>	<u>117</u>
<u>920.59</u>	<u>137</u>	<u>924.81</u>	<u>107</u>	<u>929.24</u>	<u>139</u>	<u>929.74</u>	<u>105</u>	<u>930.45</u>	<u>132</u>	<u>930.78</u>	<u>117</u>
<u>920.60</u>	<u>137</u>	<u>924.82</u>	<u>107</u>	<u>929.25</u>	<u>139</u>	<u>929.75</u>	<u>105</u>	<u>930.46</u>	<u>132</u>	<u>930.79</u>	<u>117</u>
<u>920.62</u>	<u>136</u>	<u>924.83</u>	<u>107</u>	<u>929.26</u>	<u>140</u>	<u>929.76</u>	<u>118</u>	<u>930.47</u>	<u>132</u>	<u>933.76</u>	<u>119</u>
<u>920.64</u>	<u>137</u>	<u>924.84</u>	<u>107</u>	<u>929.33</u>	<u>134</u>	<u>929.77</u>	<u>93</u>	<u>930.48</u>	<u>132</u>	<u>933.77</u>	<u>119</u>
<u>920.65</u>	<u>137</u>	<u>924.85</u>	<u>107</u>	<u>929.34</u>	<u>134</u>	<u>929.78</u>	<u>93</u>	<u>930.49</u>	<u>130</u>	<u>933.78</u>	<u>119</u>
<u>920.66</u>	<u>137</u>	<u>924.86</u>	<u>107</u>	<u>929.35</u>	<u>134</u>	<u>929.79</u>	<u>93</u>	<u>930.50</u>	<u>130</u>	<u>933.79</u>	<u>119</u>
<u>920.68</u>	<u>136</u>	<u>924.87</u>	<u>107</u>	<u>929.36</u>	<u>134</u>	<u>929.80</u>	<u>93</u>	<u>930.51</u>	<u>130</u>	<u>933.80</u>	<u>119</u>
<u>920.70</u>	<u>137</u>	<u>924.88</u>	<u>107</u>	<u>929.37</u>	<u>134</u>	<u>929.81</u>	<u>93</u>	<u>930.52</u>	<u>130</u>	<u>933.81</u>	<u>119</u>
<u>920.71</u>	<u>137</u>	<u>924.89</u>	<u>107</u>	<u>929.38</u>	<u>134</u>	<u>929.82</u>	<u>93</u>	<u>930.53</u>	<u>130</u>	<u>933.82</u>	<u>119</u>
<u>920.72</u>	<u>137</u>	<u>924.90</u>	<u>107</u>	<u>929.39</u>	<u>134</u>	<u>929.83</u>	<u>93</u>	<u>930.54</u>	<u>130</u>	<u>933.83</u>	<u>119</u>
<u>920.74</u>	<u>136</u>	<u>924.91</u>	<u>271</u>	<u>929.40</u>	<u>134</u>	<u>929.84</u>	<u>93</u>	<u>930.55</u>	<u>130</u>	<u>933.84</u>	<u>119</u>
<u>920.76</u>	<u>137</u>	<u>924.92</u>	<u>271</u>	<u>929.43</u>	<u>135</u>	<u>929.85</u>	<u>110</u>	<u>930.56</u>	<u>130</u>	<u>933.85</u>	<u>119</u>
<u>920.77</u>	<u>137</u>	<u>924.93</u>	<u>271</u>	<u>929.44</u>	<u>135</u>	<u>929.86</u>	<u>110</u>	<u>930.57</u>	<u>130</u>	<u>933.86</u>	<u>122</u>
<u>920.78</u>	<u>137</u>	<u>924.94</u>	<u>271</u>	<u>929.45</u>	<u>135</u>	<u>929.89</u>	<u>131</u>	<u>930.58</u>	<u>130</u>	<u>933.87</u>	<u>122</u>
<u>920.80</u>	<u>136</u>	<u>924.95</u>	<u>271</u>	<u>929.46</u>	<u>135</u>	<u>929.90</u>	<u>131</u>	<u>930.59</u>	<u>130</u>	<u>933.88</u>	<u>110</u>
<u>923.87</u>	<u>125</u>	<u>924.96</u>	<u>141</u>	<u>929.47</u>	<u>135</u>	<u>929.91</u>	<u>131</u>	<u>930.60</u>	<u>130</u>	<u>933.89</u>	<u>110</u>
<u>923.88</u>	<u>125</u>	<u>924.97</u>	<u>141</u>	<u>929.48</u>	<u>135</u>	<u>929.92</u>	<u>131</u>	<u>930.61</u>	<u>126</u>	<u>933.90</u>	<u>111</u>
<u>923.89</u>	<u>125</u>	<u>924.98</u>	<u>142</u>	<u>929.49</u>	<u>135</u>	<u>929.93</u>	<u>131</u>	<u>930.62</u>	<u>126</u>	<u>933.91</u>	<u>111</u>
<u>923.90</u>	<u>125</u>	<u>924.99</u>	<u>142</u>	<u>929.50</u>	<u>135</u>	<u>929.94</u>	<u>131</u>	<u>930.63</u>	<u>126</u>	<u>933.92</u>	<u>112</u>
<u>923.91</u>	<u>125</u>	<u>92471</u>	<u>118</u>	<u>929.51</u>	<u>135</u>	<u>930.31</u>	<u>129</u>	<u>930.64</u>	<u>126</u>	<u>933.93</u>	<u>112</u>
<u>923.92</u>	<u>125</u>	<u>925.35</u>	<u>123</u>	<u>929.52</u>	<u>135</u>	<u>930.32</u>	<u>129</u>	<u>930.65</u>	<u>126</u>	<u>933.99</u>	<u>111</u>
<u>923.93</u>	<u>125</u>	<u>925.43</u>	<u>123</u>	<u>929.53</u>	<u>135</u>	<u>930.33</u>	<u>129</u>	<u>930.66</u>	<u>126</u>	<u>934.00</u>	<u>111</u>
<u>923.94</u>	<u>125</u>	<u>928.97</u>	<u>98</u>	<u>929.54</u>	<u>135</u>	<u>930.34</u>	<u>129</u>	<u>930.67</u>	<u>126</u>	<u>934.01</u>	<u>120</u>
<u>923.95</u>	<u>125</u>	<u>928.98</u>	<u>98</u>	<u>929.58</u>	<u>103</u>	<u>930.35</u>	<u>129</u>	<u>930.68</u>	<u>126</u>	<u>934.02</u>	<u>120</u>
<u>923.96</u>	<u>125</u>	<u>928.99</u>	<u>98</u>	<u>929.59</u>	<u>103</u>	<u>930.36</u>	<u>129</u>	<u>930.69</u>	<u>117</u>	<u>934.03</u>	<u>120</u>
<u>923.97</u>	<u>125</u>	<u>929.00</u>	<u>98</u>	<u>929.61</u>	<u>103</u>	<u>930.37</u>	<u>129</u>	<u>930.70</u>	<u>117</u>	<u>934.04</u>	<u>120</u>



											
<u>934.05</u>	<u>120</u>	<u>934.38</u>	<u>92</u>	<u>934.71</u>	<u>92</u>	<u>935.61</u>	<u>290</u>	<u>936.85</u>	<u>102</u>	<u>938.79</u>	<u>96</u>
<u>934.06</u>	<u>120</u>	<u>934.39</u>	<u>93</u>	<u>934.72</u>	<u>92</u>	<u>935.62</u>	<u>290</u>	<u>936.86</u>	<u>102</u>	<u>938.80</u>	<u>96</u>
<u>934.07</u>	<u>120</u>	<u>934.40</u>	<u>93</u>	<u>934.73</u>	<u>92</u>	<u>935.63</u>	<u>292</u>	<u>936.89</u>	<u>325</u>	<u>938.81</u>	<u>101</u>
<u>934.08</u>	<u>120</u>	<u>934.41</u>	<u>93</u>	<u>934.74</u>	<u>92</u>	<u>935.64</u>	<u>291</u>	<u>936.92</u>	<u>327</u>	<u>938.82</u>	<u>101</u>
<u>934.09</u>	<u>120</u>	<u>934.42</u>	<u>93</u>	<u>934.75</u>	<u>93</u>	<u>935.67</u>	<u>292</u>	<u>936.94</u>	<u>329</u>	<u>938.83</u>	<u>101</u>
<u>934.10</u>	<u>120</u>	<u>934.43</u>	<u>93</u>	<u>934.76</u>	<u>93</u>	<u>935.72</u>	<u>293</u>	<u>936.95</u>	<u>329</u>	<u>938.95</u>	<u>97</u>
<u>934.11</u>	<u>91</u>	<u>934.44</u>	<u>93</u>	<u>934.77</u>	<u>93</u>	<u>935.83</u>	<u>291</u>	<u>936.96</u>	<u>325</u>	<u>939.00</u>	<u>97</u>
<u>934.12</u>	<u>91</u>	<u>934.45</u>	<u>93</u>	<u>934.78</u>	<u>93</u>	<u>935.86</u>	<u>294</u>	<u>936.97</u>	<u>328</u>	<u>939.01</u>	<u>97</u>
<u>934.13</u>	<u>91</u>	<u>934.46</u>	<u>94</u>	<u>934.79</u>	<u>93</u>	<u>936.31</u>	<u>112</u>	<u>937.30</u>	<u>116</u>	<u>939.02</u>	<u>96</u>
<u>934.14</u>	<u>91</u>	<u>934.47</u>	<u>94</u>	<u>934.80</u>	<u>93</u>	<u>936.32</u>	<u>112</u>	<u>937.31</u>	<u>116</u>	<u>939.03</u>	<u>96</u>
<u>934.15</u>	<u>121</u>	<u>934.48</u>	<u>94</u>	<u>934.81</u>	<u>93</u>	<u>936.33</u>	<u>112</u>	<u>937.40</u>	<u>138</u>	<u>939.04</u>	<u>345</u>
<u>934.16</u>	<u>121</u>	<u>934.49</u>	<u>94</u>	<u>934.82</u>	<u>94</u>	<u>936.39</u>	<u>113</u>	<u>937.41</u>	<u>138</u>	<u>939.07</u>	<u>332</u>
<u>934.17</u>	<u>121</u>	<u>934.50</u>	<u>94</u>	<u>934.83</u>	<u>94</u>	<u>936.40</u>	<u>113</u>	<u>937.42</u>	<u>138</u>	<u>939.08</u>	<u>332</u>
<u>934.18</u>	<u>121</u>	<u>934.51</u>	<u>94</u>	<u>934.84</u>	<u>94</u>	<u>936.41</u>	<u>113</u>	<u>937.43</u>	<u>138</u>	<u>939.17</u>	<u>334</u>
<u>934.19</u>	<u>121</u>	<u>934.52</u>	<u>94</u>	<u>934.85</u>	<u>94</u>	<u>936.61</u>	<u>98</u>	<u>937.51</u>	<u>363</u>	<u>939.20</u>	<u>334</u>
<u>934.20</u>	<u>91</u>	<u>934.53</u>	<u>94</u>	<u>934.86</u>	<u>94</u>	<u>936.62</u>	<u>98</u>	<u>937.61</u>	<u>143</u>	<u>939.21</u>	<u>333</u>
<u>934.21</u>	<u>91</u>	<u>934.54</u>	<u>94</u>	<u>934.87</u>	<u>94</u>	<u>936.63</u>	<u>99</u>	<u>937.62</u>	<u>143</u>	<u>939.22</u>	<u>333</u>
<u>934.22</u>	<u>91</u>	<u>934.55</u>	<u>94</u>	<u>934.88</u>	<u>94</u>	<u>936.64</u>	<u>99</u>	<u>937.64</u>	<u>377</u>	<u>939.26</u>	<u>342</u>
<u>934.23</u>	<u>91</u>	<u>934.56</u>	<u>94</u>	<u>934.89</u>	<u>94</u>	<u>936.70</u>	<u>109</u>	<u>937.65</u>	<u>375</u>	<u>939.27</u>	<u>342</u>
<u>934.24</u>	<u>91</u>	<u>934.57</u>	<u>95</u>	<u>934.90</u>	<u>94</u>	<u>936.71</u>	<u>100</u>	<u>937.74</u>	<u>381</u>	<u>939.28</u>	<u>343</u>
<u>934.25</u>	<u>91</u>	<u>934.58</u>	<u>95</u>	<u>934.91</u>	<u>94</u>	<u>936.72</u>	<u>100</u>	<u>937.75</u>	<u>381</u>	<u>939.29</u>	<u>342</u>
<u>934.26</u>	<u>91</u>	<u>934.59</u>	<u>95</u>	<u>934.92</u>	<u>94</u>	<u>936.73</u>	<u>100</u>	<u>937.88</u>	<u>360</u>	<u>939.30</u>	<u>343</u>
<u>934.27</u>	<u>91</u>	<u>934.60</u>	<u>95</u>	<u>934.93</u>	<u>95</u>	<u>936.74</u>	<u>100</u>	<u>938.10</u>	<u>143</u>	<u>939.31</u>	<u>343</u>
<u>934.28</u>	<u>92</u>	<u>934.61</u>	<u>95</u>	<u>934.94</u>	<u>95</u>	<u>936.75</u>	<u>100</u>	<u>938.69</u>	<u>97</u>	<u>939.34</u>	<u>330</u>
<u>934.29</u>	<u>92</u>	<u>934.62</u>	<u>95</u>	<u>934.95</u>	<u>95</u>	<u>936.76</u>	<u>100</u>	<u>938.70</u>	<u>97</u>	<u>939.49</u>	<u>328</u>
<u>934.30</u>	<u>92</u>	<u>934.63</u>	<u>95</u>	<u>934.96</u>	<u>95</u>	<u>936.77</u>	<u>96</u>	<u>938.71</u>	<u>97</u>	<u>939.51</u>	<u>331</u>
<u>934.31</u>	<u>92</u>	<u>934.64</u>	<u>92</u>	<u>934.97</u>	<u>95</u>	<u>936.78</u>	<u>96</u>	<u>938.72</u>	<u>97</u>	<u>939.53</u>	<u>332</u>
<u>934.32</u>	<u>92</u>	<u>934.65</u>	<u>92</u>	<u>934.98</u>	<u>95</u>	<u>936.79</u>	<u>96</u>	<u>938.73</u>	<u>97</u>	<u>939.92</u>	<u>358</u>
<u>934.33</u>	<u>92</u>	<u>934.66</u>	<u>92</u>	<u>934.99</u>	<u>95</u>	<u>936.80</u>	<u>96</u>	<u>938.74</u>	<u>97</u>	<u>939.93</u>	<u>358</u>
<u>934.34</u>	<u>92</u>	<u>934.67</u>	<u>92</u>	<u>935.52</u>	<u>295</u>	<u>936.81</u>	<u>102</u>	<u>938.75</u>	<u>96</u>	<u>939.94</u>	<u>342</u>
<u>934.35</u>	<u>92</u>	<u>934.68</u>	<u>92</u>	<u>935.53</u>	<u>295</u>	<u>936.82</u>	<u>102</u>	<u>938.76</u>	<u>96</u>	<u>939.97</u>	<u>330</u>
<u>934.36</u>	<u>92</u>	<u>934.69</u>	<u>92</u>	<u>935.54</u>	<u>295</u>	<u>936.83</u>	<u>102</u>	<u>938.77</u>	<u>96</u>	<u>939.99</u>	<u>343</u>
<u>934.37</u>	<u>92</u>	<u>934.70</u>	<u>92</u>	<u>935.55</u>	<u>295</u>	<u>936.84</u>	<u>102</u>	<u>938.78</u>	<u>96</u>	<u>940.80</u>	<u>204</u>



											
<u>941.19</u>	<u>354</u>	<u>942.10</u>	<u>384</u>	<u>942.81</u>	<u>355</u>	<u>943.26</u>	<u>351</u>	<u>944.19</u>	<u>195</u>	<u>944.53</u>	<u>353</u>
<u>941.32</u>	<u>204</u>	<u>942.15</u>	<u>341</u>	<u>942.82</u>	<u>355</u>	<u>943.27</u>	<u>351</u>	<u>944.20</u>	<u>196</u>	<u>944.54</u>	<u>361</u>
<u>941.33</u>	<u>204</u>	<u>942.16</u>	<u>341</u>	<u>942.83</u>	<u>330</u>	<u>943.28</u>	<u>351</u>	<u>944.21</u>	<u>196</u>	<u>944.57</u>	<u>203</u>
<u>941.34</u>	<u>205</u>	<u>942.27</u>	<u>332</u>	<u>942.84</u>	<u>323</u>	<u>943.29</u>	<u>351</u>	<u>944.22</u>	<u>196</u>	<u>944.58</u>	<u>190</u>
<u>941.36</u>	<u>206</u>	<u>942.28</u>	<u>332</u>	<u>942.85</u>	<u>330</u>	<u>943.30</u>	<u>351</u>	<u>944.23</u>	<u>196</u>	<u>944.59</u>	<u>193</u>
<u>941.38</u>	<u>207</u>	<u>942.33</u>	<u>376</u>	<u>942.86</u>	<u>324</u>	<u>943.31</u>	<u>352</u>	<u>944.24</u>	<u>196</u>	<u>944.60</u>	<u>193</u>
<u>941.41</u>	<u>208</u>	<u>942.34</u>	<u>376</u>	<u>942.87</u>	<u>384</u>	<u>943.36</u>	<u>359</u>	<u>944.25</u>	<u>196</u>	<u>944.61</u>	<u>193</u>
<u>941.44</u>	<u>205</u>	<u>942.38</u>	<u>380</u>	<u>942.88</u>	<u>384</u>	<u>943.37</u>	<u>359</u>	<u>944.26</u>	<u>197</u>	<u>944.62</u>	<u>193</u>
<u>941.45</u>	<u>206</u>	<u>942.39</u>	<u>380</u>	<u>942.90</u>	<u>205</u>	<u>943.38</u>	<u>367</u>	<u>944.27</u>	<u>197</u>	<u>944.63</u>	<u>193</u>
<u>941.46</u>	<u>207</u>	<u>942.41</u>	<u>330</u>	<u>942.91</u>	<u>205</u>	<u>943.39</u>	<u>367</u>	<u>944.28</u>	<u>201</u>	<u>944.64</u>	<u>193</u>
<u>941.47</u>	<u>207</u>	<u>942.42</u>	<u>323</u>	<u>942.92</u>	<u>104</u>	<u>943.40</u>	<u>367</u>	<u>944.29</u>	<u>201</u>	<u>944.65</u>	<u>191</u>
<u>941.48</u>	<u>205</u>	<u>942.43</u>	<u>369</u>	<u>942.93</u>	<u>104</u>	<u>943.41</u>	<u>367</u>	<u>944.30</u>	<u>188</u>	<u>944.66</u>	<u>191</u>
<u>941.53</u>	<u>205</u>	<u>942.45</u>	<u>368</u>	<u>942.94</u>	<u>104</u>	<u>943.63</u>	<u>358</u>	<u>944.31</u>	<u>188</u>	<u>944.67</u>	<u>191</u>
<u>941.54</u>	<u>326</u>	<u>942.46</u>	<u>372</u>	<u>942.95</u>	<u>104</u>	<u>943.64</u>	<u>358</u>	<u>944.32</u>	<u>188</u>	<u>944.68</u>	<u>191</u>
<u>941.56</u>	<u>326</u>	<u>942.47</u>	<u>372</u>	<u>942.96</u>	<u>104</u>	<u>943.65</u>	<u>358</u>	<u>944.33</u>	<u>188</u>	<u>944.69</u>	<u>191</u>
<u>941.65</u>	<u>340</u>	<u>942.49</u>	<u>377</u>	<u>942.97</u>	<u>104</u>	<u>943.66</u>	<u>358</u>	<u>944.34</u>	<u>188</u>	<u>944.70</u>	<u>191</u>
<u>941.66</u>	<u>385</u>	<u>942.50</u>	<u>370</u>	<u>942.98</u>	<u>104</u>	<u>943.82</u>	<u>357</u>	<u>944.35</u>	<u>188</u>	<u>944.71</u>	<u>94</u>
<u>941.69</u>	<u>385</u>	<u>942.51</u>	<u>370</u>	<u>942.99</u>	<u>104</u>	<u>943.83</u>	<u>357</u>	<u>944.36</u>	<u>189</u>	<u>944.72</u>	<u>94</u>
<u>941.75</u>	<u>339</u>	<u>942.52</u>	<u>379</u>	<u>943.00</u>	<u>104</u>	<u>943.84</u>	<u>361</u>	<u>944.37</u>	<u>189</u>	<u>944.73</u>	<u>95</u>
<u>941.76</u>	<u>339</u>	<u>942.53</u>	<u>370</u>	<u>943.01</u>	<u>104</u>	<u>943.85</u>	<u>361</u>	<u>944.38</u>	<u>189</u>	<u>944.74</u>	<u>95</u>
<u>941.77</u>	<u>338</u>	<u>942.60</u>	<u>368</u>	<u>943.02</u>	<u>104</u>	<u>943.86</u>	<u>361</u>	<u>944.39</u>	<u>189</u>	<u>944.75</u>	<u>199</u>
<u>941.78</u>	<u>338</u>	<u>942.62</u>	<u>378</u>	<u>943.03</u>	<u>104</u>	<u>943.90</u>	<u>360</u>	<u>944.40</u>	<u>189</u>	<u>944.76</u>	<u>199</u>
<u>941.79</u>	<u>338</u>	<u>942.63</u>	<u>374</u>	<u>943.04</u>	<u>104</u>	<u>943.91</u>	<u>356</u>	<u>944.41</u>	<u>189</u>	<u>944.77</u>	<u>199</u>
<u>941.80</u>	<u>339</u>	<u>942.64</u>	<u>372</u>	<u>943.05</u>	<u>104</u>	<u>943.92</u>	<u>356</u>	<u>944.42</u>	<u>190</u>	<u>944.78</u>	<u>199</u>
<u>941.81</u>	<u>339</u>	<u>942.65</u>	<u>373</u>	<u>943.06</u>	<u>118</u>	<u>943.93</u>	<u>362</u>	<u>944.43</u>	<u>190</u>	<u>944.79</u>	<u>199</u>
<u>941.84</u>	<u>339</u>	<u>942.67</u>	<u>384</u>	<u>943.09</u>	<u>366</u>	<u>943.96</u>	<u>355</u>	<u>944.45</u>	<u>190</u>	<u>944.80</u>	<u>199</u>
<u>941.85</u>	<u>339</u>	<u>942.68</u>	<u>338</u>	<u>943.10</u>	<u>374</u>	<u>943.97</u>	<u>362</u>	<u>944.46</u>	<u>190</u>	<u>944.81</u>	<u>200</u>
<u>941.86</u>	<u>356</u>	<u>942.69</u>	<u>338</u>	<u>943.11</u>	<u>374</u>	<u>943.98</u>	<u>355</u>	<u>944.47</u>	<u>190</u>	<u>944.82</u>	<u>200</u>
<u>941.87</u>	<u>354</u>	<u>942.74</u>	<u>331</u>	<u>943.12</u>	<u>335</u>	<u>944.14</u>	<u>195</u>	<u>944.48</u>	<u>192</u>	<u>944.83</u>	<u>200</u>
<u>941.88</u>	<u>354</u>	<u>942.75</u>	<u>327</u>	<u>943.21</u>	<u>335</u>	<u>944.15</u>	<u>195</u>	<u>944.49</u>	<u>192</u>	<u>944.84</u>	<u>200</u>
<u>941.91</u>	<u>341</u>	<u>942.78</u>	<u>368</u>	<u>943.22</u>	<u>336</u>	<u>944.16</u>	<u>195</u>	<u>944.50</u>	<u>192</u>	<u>944.85</u>	<u>200</u>
<u>942.08</u>	<u>385</u>	<u>942.79</u>	<u>370</u>	<u>943.23</u>	<u>336</u>	<u>944.17</u>	<u>195</u>	<u>944.51</u>	<u>192</u>	<u>944.86</u>	<u>200</u>
<u>942.09</u>	<u>331</u>	<u>942.80</u>	<u>379</u>	<u>943.25</u>	<u>351</u>	<u>944.18</u>	<u>195</u>	<u>944.52</u>	<u>353</u>	<u>944.87</u>	<u>194</u>

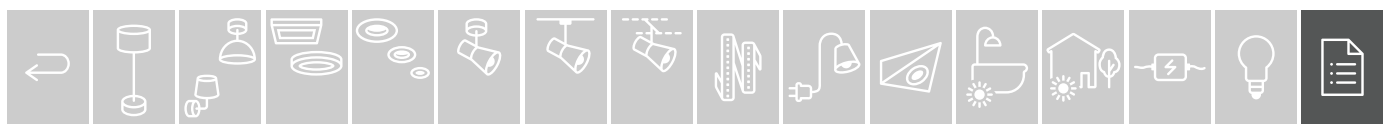

<u>944.88</u>	<u>194</u>	<u>945.79</u>	<u>348</u>	<u>953.20</u>	<u>166</u>	<u>953.87</u>	<u>128</u>	<u>954.57</u>	<u>169</u>	<u>955.11</u>	<u>156</u>
<u>944.89</u>	<u>194</u>	<u>945.80</u>	<u>348</u>	<u>953.25</u>	<u>179</u>	<u>953.88</u>	<u>374</u>	<u>954.58</u>	<u>169</u>	<u>955.19</u>	<u>155</u>
<u>944.90</u>	<u>189</u>	<u>945.81</u>	<u>348</u>	<u>953.26</u>	<u>179</u>	<u>953.89</u>	<u>133</u>	<u>954.59</u>	<u>164</u>	<u>955.20</u>	<u>168</u>
<u>944.92</u>	<u>189</u>	<u>945.82</u>	<u>348</u>	<u>953.27</u>	<u>179</u>	<u>953.90</u>	<u>133</u>	<u>954.61</u>	<u>164</u>	<u>955.25</u>	<u>162</u>
<u>944.94</u>	<u>189</u>	<u>945.83</u>	<u>348</u>	<u>953.29</u>	<u>163</u>	<u>953.91</u>	<u>133</u>	<u>954.62</u>	<u>164</u>	<u>955.26</u>	<u>162</u>
<u>944.96</u>	<u>201</u>	<u>945.84</u>	<u>348</u>	<u>953.30</u>	<u>163</u>	<u>953.92</u>	<u>133</u>	<u>954.63</u>	<u>163</u>	<u>955.51</u>	<u>182</u>
<u>945.04</u>	<u>359</u>	<u>945.85</u>	<u>347</u>	<u>953.31</u>	<u>163</u>	<u>953.93</u>	<u>366</u>	<u>954.65</u>	<u>173</u>	<u>955.52</u>	<u>182</u>
<u>945.05</u>	<u>371</u>	<u>945.86</u>	<u>347</u>	<u>953.33</u>	<u>163</u>	<u>953.95</u>	<u>155</u>	<u>954.66</u>	<u>173</u>	<u>955.53</u>	<u>182</u>
<u>945.10</u>	<u>347</u>	<u>945.89</u>	<u>201</u>	<u>953.35</u>	<u>164</u>	<u>954.15</u>	<u>178</u>	<u>954.69</u>	<u>154</u>	<u>955.56</u>	<u>275</u>
<u>945.18</u>	<u>347</u>	<u>945.91</u>	<u>201</u>	<u>953.36</u>	<u>164</u>	<u>954.16</u>	<u>180</u>	<u>954.71</u>	<u>157</u>	<u>955.57</u>	<u>275</u>
<u>945.30</u>	<u>337</u>	<u>945.93</u>	<u>201</u>	<u>953.37</u>	<u>165</u>	<u>954.17</u>	<u>180</u>	<u>954.73</u>	<u>157</u>	<u>955.58</u>	<u>275</u>
<u>945.33</u>	<u>337</u>	<u>946.66</u>	<u>376</u>	<u>953.38</u>	<u>165</u>	<u>954.18</u>	<u>180</u>	<u>954.74</u>	<u>157</u>	<u>955.59</u>	<u>275</u>
<u>945.36</u>	<u>337</u>	<u>949.71</u>	<u>168</u>	<u>953.39</u>	<u>165</u>	<u>954.23</u>	<u>269</u>	<u>954.77</u>	<u>174</u>	<u>955.60</u>	<u>275</u>
<u>945.37</u>	<u>337</u>	<u>949.72</u>	<u>168</u>	<u>953.42</u>	<u>165</u>	<u>954.24</u>	<u>269</u>	<u>954.78</u>	<u>174</u>	<u>955.61</u>	<u>275</u>
<u>945.50</u>	<u>349</u>	<u>949.73</u>	<u>167</u>	<u>953.43</u>	<u>165</u>	<u>954.25</u>	<u>273</u>	<u>954.79</u>	<u>174</u>	<u>955.62</u>	<u>276</u>
<u>945.51</u>	<u>348</u>	<u>949.74</u>	<u>167</u>	<u>953.44</u>	<u>165</u>	<u>954.26</u>	<u>273</u>	<u>954.80</u>	<u>174</u>	<u>955.64</u>	<u>276</u>
<u>945.52</u>	<u>348</u>	<u>949.75</u>	<u>167</u>	<u>953.51</u>	<u>173</u>	<u>954.27</u>	<u>274</u>	<u>954.83</u>	<u>175</u>	<u>955.66</u>	<u>276</u>
<u>945.55</u>	<u>349</u>	<u>949.79</u>	<u>154</u>	<u>953.52</u>	<u>173</u>	<u>954.28</u>	<u>274</u>	<u>954.85</u>	<u>175</u>	<u>955.68</u>	<u>277</u>
<u>945.56</u>	<u>349</u>	<u>949.98</u>	<u>170</u>	<u>953.54</u>	<u>173</u>	<u>954.29</u>	<u>274</u>	<u>954.86</u>	<u>175</u>	<u>955.69</u>	<u>277</u>
<u>945.57</u>	<u>340</u>	<u>950.16</u>	<u>177</u>	<u>953.57</u>	<u>153</u>	<u>954.30</u>	<u>272</u>	<u>954.92</u>	<u>173</u>	<u>955.70</u>	<u>277</u>
<u>945.58</u>	<u>340</u>	<u>950.86</u>	<u>178</u>	<u>953.58</u>	<u>153</u>	<u>954.31</u>	<u>272</u>	<u>954.93</u>	<u>153</u>	<u>955.71</u>	<u>277</u>
<u>945.60</u>	<u>341</u>	<u>951.26</u>	<u>178</u>	<u>953.59</u>	<u>153</u>	<u>954.32</u>	<u>272</u>	<u>954.94</u>	<u>182</u>	<u>955.72</u>	<u>277</u>
<u>945.61</u>	<u>341</u>	<u>951.36</u>	<u>179</u>	<u>953.62</u>	<u>161</u>	<u>954.36</u>	<u>172</u>	<u>954.95</u>	<u>182</u>	<u>955.73</u>	<u>277</u>
<u>945.62</u>	<u>341</u>	<u>951.40</u>	<u>179</u>	<u>953.63</u>	<u>161</u>	<u>954.37</u>	<u>172</u>	<u>954.96</u>	<u>178</u>	<u>968.15</u>	<u>183</u>
<u>945.70</u>	<u>371</u>	<u>951.49</u>	<u>178</u>	<u>953.73</u>	<u>155</u>	<u>954.38</u>	<u>173</u>	<u>954.97</u>	<u>178</u>	<u>968.19</u>	<u>183</u>
<u>945.71</u>	<u>371</u>	<u>951.77</u>	<u>169</u>	<u>953.74</u>	<u>155</u>	<u>954.40</u>	<u>173</u>	<u>954.98</u>	<u>178</u>	<u>968.20</u>	<u>177</u>
<u>945.72</u>	<u>373</u>	<u>952.69</u>	<u>159</u>	<u>953.79</u>	<u>127</u>	<u>954.42</u>	<u>173</u>	<u>955.01</u>	<u>166</u>	<u>968.21</u>	<u>177</u>
<u>945.73</u>	<u>378</u>	<u>952.70</u>	<u>159</u>	<u>953.80</u>	<u>127</u>	<u>954.44</u>	<u>173</u>	<u>955.02</u>	<u>166</u>	<u>968.22</u>	<u>177</u>
<u>945.74</u>	<u>331</u>	<u>952.71</u>	<u>159</u>	<u>953.81</u>	<u>127</u>	<u>954.45</u>	<u>173</u>	<u>955.06</u>	<u>160</u>	<u>968.31</u>	<u>180</u>
<u>945.75</u>	<u>331</u>	<u>952.72</u>	<u>159</u>	<u>953.82</u>	<u>127</u>	<u>954.46</u>	<u>155</u>	<u>955.07</u>	<u>160</u>	<u>968.33</u>	<u>178</u>
<u>945.76</u>	<u>382</u>	<u>952.73</u>	<u>160</u>	<u>953.84</u>	<u>128</u>	<u>954.47</u>	<u>155</u>	<u>955.08</u>	<u>160</u>	<u>968.34</u>	<u>178</u>
<u>945.77</u>	<u>375</u>	<u>952.83</u>	<u>160</u>	<u>953.85</u>	<u>128</u>	<u>954.55</u>	<u>157</u>	<u>955.09</u>	<u>160</u>	<u>968.54</u>	<u>178</u>
<u>945.78</u>	<u>382</u>	<u>953.19</u>	<u>166</u>	<u>953.86</u>	<u>128</u>	<u>954.56</u>	<u>157</u>	<u>955.10</u>	<u>156</u>	<u>968.85</u>	<u>180</u>

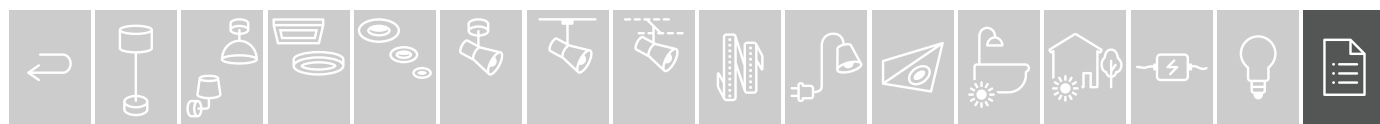

<u>968.86</u>	<u>180</u>	<u>969.40</u>	<u>160</u>	<u>976.79</u>	<u>180</u>	<u>979.32</u>	<u>389</u>	<u>998.95</u>	<u>279</u>	<u>999.54</u>	<u>285</u>
<u>968.91</u>	<u>157</u>	<u>969.41</u>	<u>156</u>	<u>976.82</u>	<u>178</u>	<u>984.02</u>	<u>296</u>	<u>998.96</u>	<u>279</u>	<u>999.55</u>	<u>285</u>
<u>968.93</u>	<u>183</u>	<u>969.42</u>	<u>155</u>	<u>976.83</u>	<u>178</u>	<u>984.07</u>	<u>296</u>	<u>999.05</u>	<u>314</u>	<u>999.56</u>	<u>288</u>
<u>969.02</u>	<u>178</u>	<u>969.58</u>	<u>170</u>	<u>976.84</u>	<u>178</u>	<u>984.32</u>	<u>297</u>	<u>999.20</u>	<u>294</u>	<u>999.57</u>	<u>288</u>
<u>969.03</u>	<u>178</u>	<u>969.60</u>	<u>180</u>	<u>976.85</u>	<u>180</u>	<u>984.49</u>	<u>297</u>	<u>999.21</u>	<u>294</u>	<u>999.58</u>	<u>288</u>
<u>969.04</u>	<u>178</u>	<u>969.61</u>	<u>178</u>	<u>976.86</u>	<u>179</u>	<u>984.62</u>	<u>297</u>	<u>999.22</u>	<u>108</u>	<u>999.59</u>	<u>288</u>
<u>969.05</u>	<u>178</u>	<u>969.62</u>	<u>161</u>	<u>976.87</u>	<u>179</u>	<u>984.66</u>	<u>296</u>	<u>999.23</u>	<u>108</u>	<u>999.60</u>	<u>285</u>
<u>969.06</u>	<u>179</u>	<u>969.63</u>	<u>161</u>	<u>976.88</u>	<u>178</u>	<u>984.74</u>	<u>297</u>	<u>999.24</u>	<u>108</u>	<u>999.61</u>	<u>285</u>
<u>969.07</u>	<u>179</u>	<u>969.64</u>	<u>179</u>	<u>977.01</u>	<u>388</u>	<u>987.73</u>	<u>115</u>	<u>999.25</u>	<u>108</u>	<u>999.62</u>	<u>286</u>
<u>969.08</u>	<u>179</u>	<u>969.65</u>	<u>179</u>	<u>977.15</u>	<u>388</u>	<u>988.48</u>	<u>345</u>	<u>999.26</u>	<u>108</u>	<u>999.63</u>	<u>286</u>
<u>969.09</u>	<u>179</u>	<u>969.66</u>	<u>165</u>	<u>977.25</u>	<u>388</u>	<u>988.49</u>	<u>345</u>	<u>999.27</u>	<u>108</u>	<u>999.64</u>	<u>286</u>
<u>969.10</u>	<u>179</u>	<u>969.67</u>	<u>165</u>	<u>977.28</u>	<u>387</u>	<u>988.50</u>	<u>345</u>	<u>999.28</u>	<u>108</u>	<u>999.65</u>	<u>286</u>
<u>969.11</u>	<u>163</u>	<u>969.68</u>	<u>152</u>	<u>977.29</u>	<u>387</u>	<u>988.78</u>	<u>116</u>	<u>999.29</u>	<u>108</u>	<u>999.66</u>	<u>286</u>
<u>969.12</u>	<u>152</u>	<u>969.69</u>	<u>152</u>	<u>977.38</u>	<u>391</u>	<u>988.96</u>	<u>363</u>	<u>999.30</u>	<u>108</u>	<u>999.67</u>	<u>286</u>
<u>969.13</u>	<u>152</u>	<u>969.70</u>	<u>152</u>	<u>977.51</u>	<u>387</u>	<u>988.97</u>	<u>363</u>	<u>999.31</u>	<u>108</u>	<u>999.68</u>	<u>287</u>
<u>969.14</u>	<u>182</u>	<u>969.71</u>	<u>152</u>	<u>977.53</u>	<u>387</u>	<u>989.40</u>	<u>116</u>	<u>999.32</u>	<u>108</u>	<u>999.69</u>	<u>287</u>
<u>969.15</u>	<u>158</u>	<u>969.72</u>	<u>171</u>	<u>977.62</u>	<u>389</u>	<u>989.43</u>	<u>116</u>	<u>999.33</u>	<u>108</u>	<u>999.70</u>	<u>287</u>
<u>969.16</u>	<u>180</u>	<u>969.73</u>	<u>171</u>	<u>977.63</u>	<u>390</u>	<u>989.68</u>	<u>114</u>	<u>999.34</u>	<u>109</u>	<u>999.71</u>	<u>287</u>
<u>969.17</u>	<u>160</u>	<u>969.74</u>	<u>171</u>	<u>977.65</u>	<u>181</u>	<u>989.71</u>	<u>114</u>	<u>999.35</u>	<u>109</u>	<u>999.72</u>	<u>284</u>
<u>969.18</u>	<u>161</u>	<u>969.75</u>	<u>170</u>	<u>977.66</u>	<u>181</u>	<u>990.68</u>	<u>313</u>	<u>999.36</u>	<u>109</u>	<u>999.73</u>	<u>282</u>
<u>969.19</u>	<u>172</u>	<u>969.76</u>	<u>170</u>	<u>977.67</u>	<u>389</u>	<u>993.85</u>	<u>313</u>	<u>999.37</u>	<u>109</u>	<u>999.74</u>	<u>283</u>
<u>969.20</u>	<u>166</u>	<u>971.1229</u>	<u>207</u>	<u>977.81</u>	<u>388</u>	<u>994.95</u>	<u>140</u>	<u>999.40</u>	<u>122</u>	<u>999.75</u>	<u>283</u>
<u>969.21</u>	<u>181</u>	<u>972.83</u>	<u>211</u>	<u>977.82</u>	<u>388</u>	<u>996.79</u>	<u>314</u>	<u>999.41</u>	<u>122</u>	<u>999.76</u>	<u>289</u>
<u>969.22</u>	<u>157</u>	<u>974.74</u>	<u>182</u>	<u>978.019</u>	<u>211</u>	<u>996.80</u>	<u>315</u>	<u>999.42</u>	<u>122</u>	<u>999.89</u>	<u>111</u>
<u>969.23</u>	<u>156</u>	<u>975.99</u>	<u>178</u>	<u>978.38</u>	<u>201</u>	<u>998.25</u>	<u>272</u>	<u>999.43</u>	<u>122</u>	<u>999.90</u>	<u>111</u>
<u>969.24</u>	<u>155</u>	<u>976.02</u>	<u>167</u>	<u>978.39</u>	<u>201</u>	<u>998.42</u>	<u>173</u>	<u>999.46</u>	<u>289</u>	<u>999.91</u>	<u>108</u>
<u>969.25</u>	<u>161</u>	<u>976.12</u>	<u>161</u>	<u>978.40</u>	<u>201</u>	<u>998.65</u>	<u>293</u>	<u>999.47</u>	<u>289</u>	<u>999.92</u>	<u>286</u>
<u>969.26</u>	<u>164</u>	<u>976.13</u>	<u>161</u>	<u>978.41</u>	<u>211</u>	<u>998.89</u>	<u>278</u>	<u>999.48</u>	<u>289</u>		
<u>969.27</u>	<u>155</u>	<u>976.48</u>	<u>179</u>	<u>978.45</u>	<u>211</u>	<u>998.90</u>	<u>278</u>	<u>999.49</u>	<u>284</u>		
<u>969.36</u>	<u>157</u>	<u>976.49</u>	<u>179</u>	<u>979.047</u>	<u>210</u>	<u>998.91</u>	<u>278</u>	<u>999.50</u>	<u>284</u>		
<u>969.37</u>	<u>157</u>	<u>976.55</u>	<u>180</u>	<u>979.055</u>	<u>210</u>	<u>998.92</u>	<u>278</u>	<u>999.51</u>	<u>288</u>		
<u>969.38</u>	<u>157</u>	<u>976.56</u>	<u>179</u>	<u>979.057</u>	<u>210</u>	<u>998.93</u>	<u>278</u>	<u>999.52</u>	<u>285</u>		
<u>969.39</u>	<u>158</u>	<u>976.57</u>	<u>179</u>	<u>979.069</u>	<u>210</u>	<u>998.94</u>	<u>279</u>	<u>999.53</u>	<u>285</u>		

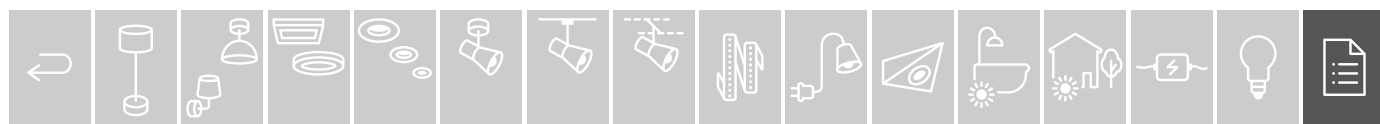

<b>A</b> <b>ÖSTERREICH</b> Paulmann Ges.m.b.H Linzerstrasse 89-91 A-3003 Gablitz ☎ +43 2231 66492 ☎ +43 2231 6649217 info@paulmann.at	<b>D</b> <b>DEUTSCHLAND</b> Paulmann Licht GmbH Quezinger Feld 2 31832 Springe Völkxen ☎ +49 5041 998-0 ☎ +49 5041 998-119 info@paulmann.de	<b>GR</b> <b>ΕΛΛΑΔΑ</b> Paulmann Licht GmbH Quezinger Feld 2 31832 Springe Völkxen ☎ +49 5041 998-0 ☎ +49 5041 998-119 info@paulmann.de	<b>MK</b> <b>MAKEDONIJA</b> DPTUUT „EL-LUKS“ DOOEL ul : Leninova br. 79 MK-2400 Strumica ☎ +389 75 301 109 ☎ +389 34 320 133 info@el-lux.com.mk	<b>S</b> <b>SVERIGE</b> Paulmann Licht GmbH Quezinger Feld 2 D-31832 Springe ☎ +49 5041 998-0 ☎ +49 5041 998-169 info@paulmann.de
<b>AND</b> <b>ANDORRA</b> Paulmann Licht GmbH Quezinger Feld 2 31832 Springe Völkxen ☎ +49 5041 998-0 ☎ +49 5041 998-119 info@paulmann.de	<b>DK</b> <b>DANMARK</b> SB Butiksservice Radhustorvet 11 DK-8700 Horsens ☎ +45 7023 2730 ☎ +49 7023 2703 mb@sb.dk	<b>H</b> <b>MAGYARORSZÁG</b> DINOCOOP GmbH Radvány u. 24 1118 Budapest XI ☎ +36-1-3193064 ☎ +36-1-3193066 dinocoop@dinocoop.hu	<b>MNE</b> <b>CRNA GORA</b> Mikrut D.O.O. Maciej Mikrut Ulica Ivana Pengova 18 SI- 1230 Domzale ☎ +386 31518153 ☎ +386 172 19514 mmikrut@paulmann.si	<b>SK</b> <b>SLOVAKIA</b> Ing. Radek Brada Náměstí Na Sádkách 705 25241 Dolní Břežany ☎ +420 602331140 ☎ +420 241416267 brada.radek@volny.cz  AULIX lighting spol. s r.o. Náměstí Na Sádkách 705 252 41 Dolní Břežany Mobil: +420 702 053 063 Tel.: +420 241 402 565 E-mail: info@aulix.cz Czech republic
<b>B</b> <b>BELGIË</b> VSA Hagelberg 29 B-2440 Geel ☎ +31 499 551460 ☎ +31 499 575795 Paulmann@vanspijk.nl	<b>E</b> <b>ESPAÑA</b> Paulmann Licht GmbH Quezinger Feld 2 31832 Springe Völkxen ☎ +49 5041 998-0 ☎ +49 5041 998-119 info@paulmann.de	<b>HR</b> <b>HRVATSKA</b> Mikrut D.O.O. Maciej Mikrut Ulica Ivana Pengova 18 SI- 1230 Domzale ☎ +386 31518153 ☎ +386 17219514 mmikrut@paulmann.si	<b>N</b> <b>NORGE</b> Lyskomponenter AS Sagmyra 2A N-4624 Kristiansand S ☎ +47 38003636 ☎ +47 38003639 firmapost@lys Komponenter.no	<b>SLO</b> <b>SLOVENIJA</b> Mikrut D.O.O. Maciej Mikrut Ulica Ivana Pengova 18 SI- 1230 Domzale ☎ +386 31518153 ☎ +386 172 19514 mmikrut@paulmann.si
<b>BG</b> <b>БЪЛГАРИЯ</b> Mankovski Ltd. 3 Pop Dimitar Street fl.5 ap. 26 9000 Varna ☎ +359 886654093 i_mankovski@abv.bg	<b>EST</b> <b>EESTI</b> SIA Paulmann-Gaisma Gertrudes lela 53-1A LV- 1011 Riga ☎ +371 67280542 ☎ +371 67542413 Paulmann@latnet.lv	<b>I</b> <b>ITALIA</b> TreEsse Srl Via Gastone Breddo, 8c 50041 Calenzano (Firenze) Italia ☎ +39 055 4211598 ☎ +39 055 0457871 elena@treessesrl.com	<b>NL</b> <b>NEDERLAND</b> VSA De Scheper 402 NL-5688HP Oirschot ☎ +31 499 551460 ☎ +31 499 575795 Paulmann@vanspijk.nl	<b>SRB</b> <b>REPUBLIKA SRBIJA</b> Mikrut D.O.O. Maciej Mikrut Ulica Ivana Pengova 18 SI- 1230 Domzale ☎ +386 31518153 ☎ +386 172 19514 mmikrut@paulmann.si
<b>BIH</b> <b>BOSNIA-HERCEGOVINA</b> Mikrut D.O.O. Maciej Mikrut Ulica Ivana Pengova 18 SI- 1230 Domzale ☎ +386 31518153 ☎ +386 17219514 mmikrut@paulmann.si	<b>F</b> <b>FRANCE</b> Paulmann Lumière S.A.S. 21, rue Desaix- CS 21076 F-67452 Mundolsheim Cedex ☎ +33 3 90203737 ☎ +33 3 90203757 comm@paulmann.fr	<b>IS</b> <b>ISLAND</b> Johann Olafsson & Co Krokahals 3 IS-110 Reykjavik ☎ +354- 5331904 ☎ +354- 5331901 jarni@olafsson.is	<b>P</b> <b>PORTUGAL</b> Paulmann Licht GmbH Quezinger Feld 2 31832 Springe Völkxen ☎ +49 5041 998-0 ☎ +49 5041 998-119 info@paulmann.de	<b>TR</b> <b>TÜRKIYE</b> Paulmann Licht GmbH Quezinger Feld 2 D-31832 Springe ☎ +49 5041 998-0 ☎ +49 5041 998-169 info@paulmann.de
<b>CH</b> <b>SCHWEIZ</b> Puag AG Oberebenenstrasse 51 CH-5620 Bremgarten ☎ +41 56 648 88 48 ☎ +41 56 648 88 80 paulmann@puag.ch	<b>FIN</b> <b>SUOMI (FINLAND)</b> Oy Hedtec Ab Hedengren Yhtiot PL 110 00201 Helsinki ☎ +358 2 70 638 000 valaistus@hedtec.fi	<b>L</b> <b>LUXEMBOURG</b> VSA Hagelberg 29 B-2440 Geel ☎ +31 499 551460 ☎ +31 499 575795 Paulmann@vanspijk.nl	<b>PL</b> <b>POLSKA</b> "LŁ" Spółka z ograniczoną odpowiedzialnością sp. k. ul. Wrocławska 43 Byków; 55-095 Mirków ☎ +48 71 39 80 800 ☎ +48 71 39 80 802 paulmann@langelukaszuk.pl	
<b>CY</b> <b>ΚΥΠΡΟΣ</b> Paulmann Licht GmbH Quezinger Feld 2 31832 Springe Völkxen ☎ +49 5041 998-0 ☎ +49 5041 998-119 info@paulmann.de	<b>FL</b> <b>LIECHTENSTEIN</b> Puag AG Oberebenenstrasse 51 CH-5620 Bremgarten ☎ +41/56-6488855 ☎ +41/56-6488850 info@puag.ch	<b>LT</b> <b>LIETUVA</b> SIA Paulmann-Gaisma Gertrudes lela 53-1A LV- 1011 Riga ☎ +371 67280542 ☎ +371 67542413 Paulmann@latnet.lv	<b>RO</b> <b>ROMANIA</b> Atrium Design SRL Str. Balciului, no.1 Sector 2, RO-021501 Bucharest ☎ +40 21 252 4653 ☎ +40 21 252 4654 atrium@atrium.ro	
<b>CZ</b> <b>ČESKÁ REPUBLIKA</b> Ing. Radek Brada Náměstí Na Sádkách 705 25241 Dolní Břežany ☎ +420 602331140 ☎ +420 241416267 brada.radek@volny.cz  AULIX lighting spol. s r.o. Náměstí Na Sádkách 705 252 41 Dolní Břežany Mobil: +420 702 053 063 Tel.: +420 241 402 565 E-mail: info@aulix.cz Czech republic	<b>GB</b> <b>UNITED KINGDOM</b> Light Source Europe Ltd. 6 Great Western Business Park McKenzie Way Worcester WR4 9PT ☎ +44 1905 22243 ☎ +44 1905 611263 sales@ltselighting.com	<b>LV</b> <b>LATVIJA</b> SIA Paulmann-Gaisma Gertrudes lela 53-1A LV- 1011 Riga ☎ +371 67280542 ☎ +371 67542413 paulmann@latnet.lv	<b>RUS</b> <b>РОССИЯ</b> Лайт Капитал 000 ул.Выборгская д.16 стр.1 оф.А809 125212, г.Москва ☎ +7 495 514-19-08 ☎ +7 495 514-19-08 info@paulmann.ru	



Bemaßung von Artikeln  
Dimension des articles  
Maten van de artikelen

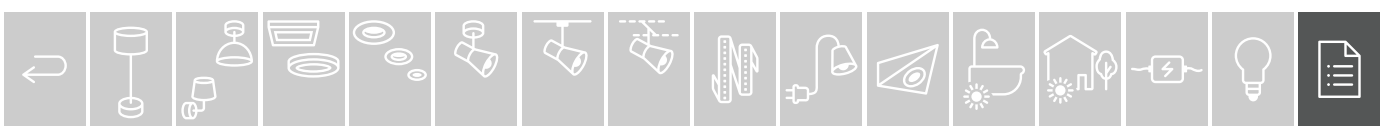
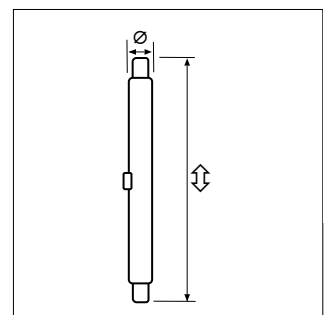
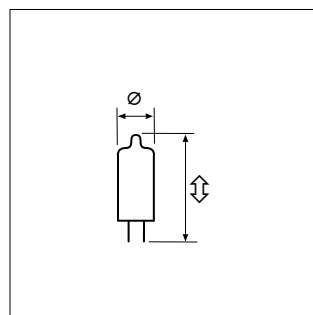
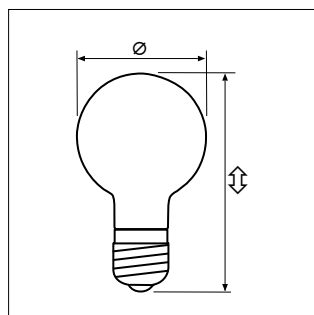
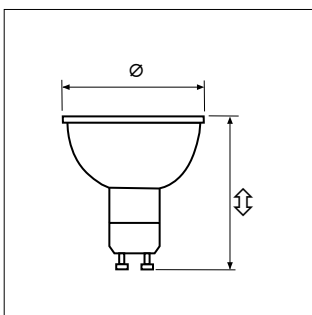
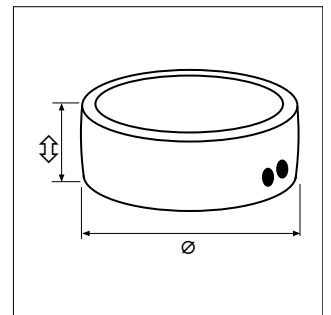
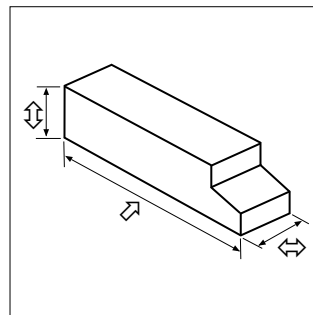
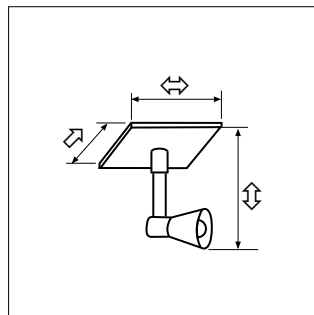
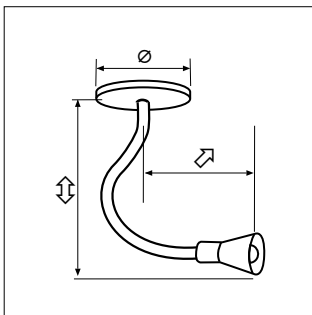
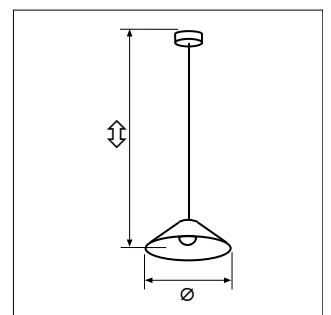
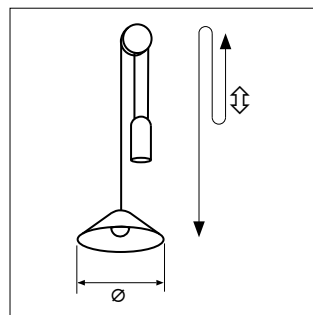
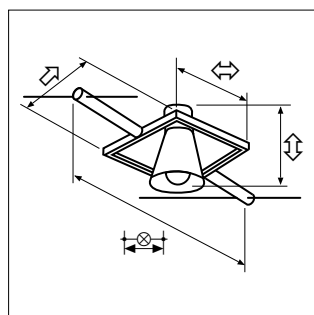
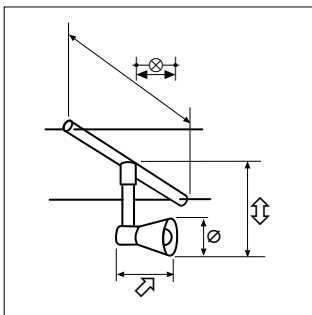
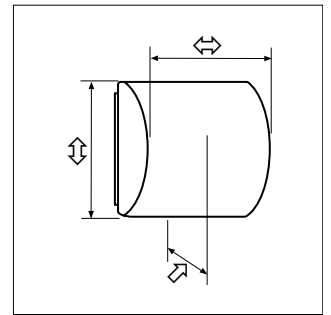
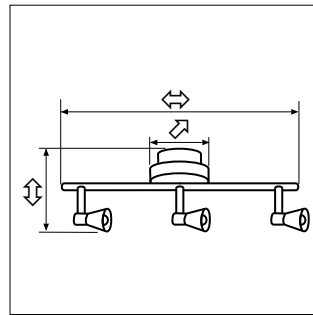
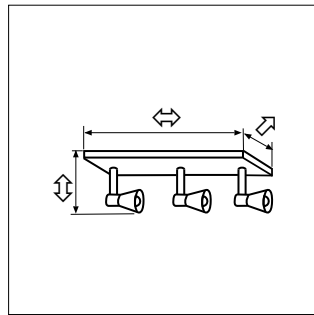
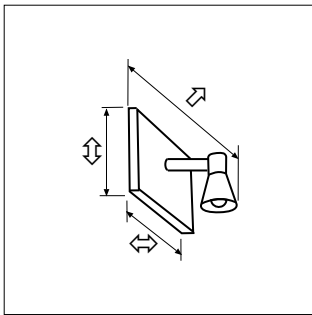
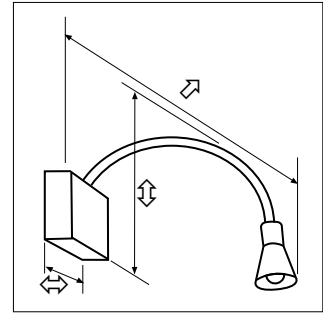
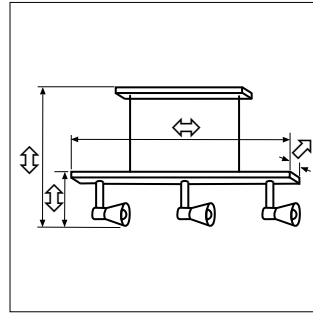
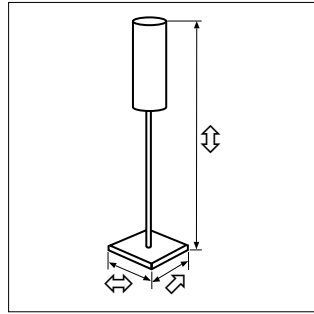
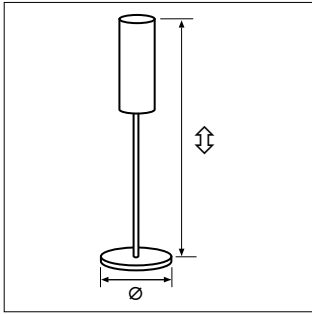



**D**  
**Garantiebedingungen**  
**Paulmann Licht GmbH**

Die Paulmann Licht GmbH garantiert nichtgewerblichen Kunden die einwandfreie Funktion der mit einem entsprechenden Garantievermerk ausgezeichneten Produkte für einen Zeitraum von 5 Jahren ab Kauf. Unsere vollständigen Garantiebedingungen finden Sie auf unserer Website: [www.paulmann.com/guarantee](http://www.paulmann.com/guarantee)

Alle Abbildungen und Angaben bezüglich Maße, Farbe usw. unterliegen eventuellen produktionstechnischen Toleranzen und sind unverbindlich. Produktänderungen behalten wir uns jederzeit vor. Wir arbeiten auf der Grundlage unserer Liefer- und Zahlungsbedingungen. Diese erhalten Sie gerne auf Anfrage oder unter [www.paulmann.com](http://www.paulmann.com)

Sicherheitsprüfzeichen des Verband Deutscher Elektrotechniker und der Technischen Überwachungsvereine. Paulmann steht für höchste Sicherheit und Qualität. Alle unsere Artikel entsprechen den festgelegten europäischen Normen. Paulmann Artikel sind, auch wenn eine Sicherheitsprüfung nicht zwingend vorgeschrieben ist, von VDE, TÜV oder Paulmann Qualitätssicherung geprüft. Diese sind im Katalog entsprechend gekennzeichnet.

Unsere Produkte aus Naturwerkstoffen und handgefertigten Gläsern sind einzigartig, sie unterliegen natürlichen Schwankungen in Farbe und Struktur.

Farbe

Material

Schutzklasse 2

Schutzklasse 3

Kaltlichtspiegel

Niederdruck

Produkt mit begrenzter Oberflächen-temperatur

Die Leuchte ist nur geeignet zur Montage auf nicht entflammaren Materialien.

Schutzarten IP

Erläuterungen siehe Seite 445

Rostfrei

einstellbare Farben

blinkend

Freeze-Funktion

Flashlight-Funktion

Sound-Sensor

Mit Schalter

**F**  
**Conditions de garantie de**  
**Paulmann Licht GmbH**

La société Paulmann Licht GmbH garantit aux clients résidentiels le fonctionnement impeccable des produits comportant la signalisation de garantie correspondante pendant 5 ans à compter de la date d'achat. L'ensemble de nos conditions de garantie est disponible sur notre site Web : [www.paulmann.com/guarantee](http://www.paulmann.com/guarantee)

Toutes les illustrations et les indications relatives aux dimensions, aux couleurs, etc. peuvent éventuellement présenter des différences du fait des techniques de production et n'ont aucun caractère d'engagement. Nous nous réservons le droit d'apporter des modifications aux produits à tout moment. Nous travaillons sur la base de nos conditions de livraison et de paiement. Vous pouvez les obtenir sur simple demande ou en consultant le site Internet [www.paulmann.com](http://www.paulmann.com)

Symboles de sécurité de l'association des électrotechniciens allemands et des organismes de contrôle technique. Paulmann est synonyme de qualité et de sécurité optimales. Tous nos articles sont conformes aux normes européennes applicables. Les articles Paulmann sont contrôlés par le VDE, le TÜV ou par le service d'assurance qualité Paulmann, même lorsque le contrôle de sécurité n'est pas impérativement prescrit. Ces contrôles sont marqués de repères dans le catalogue.

Nos produits en matériaux naturels et verres fabriqués à la main sont uniques et sont soumis aux variations naturelles chromatiques et structurelles.

couleur

matériau

Classe de protection 2

Classe de protection 3

Dichroïque

Basse pression

Produit avec température de surface limitée

L'ampoule convient uniquement pour être montée sur des matériaux non inflammables.

Types de protection IP

Explications voir page 445

Inoxydable

Couleurs réglables

Clignotant

Fonction Freeze

Fonction Flash

Capteur son

Avec commutateur

**NL**  
**Garantievoorwaarden**  
**Paulmann Licht GmbH**

Paulmann Licht GmbH garandeert niet-commerciële klanten de onberispelijke werking van de met een overeenkomstig garantiebewijs gekenmerkte producten gedurende 5 jaar vanaf datum van aankoop. Onze volledige garantievoorwaarden vindt u op onze website: [www.paulmann.com/guarantee](http://www.paulmann.com/guarantee)

Alle afbeeldingen en gegevens met betrekking tot maten, kleur enz. kunnen om productietechnische redenen afwijken en zijn vrijblijvend. Productwijzigingen behouden wij ons ten alle tijden voor. Wij werken op basis van onze leverings- en betalingsvoorwaarden. Deze verkrijgt op aanvraag of onder [www.paulmann.com](http://www.paulmann.com)

Keurmerk van de VDE en de TÜV. Paulmann staat garant voor de hoogste mate van veiligheid en kwaliteit. Al onze artikelen voldoen aan de vastgestelde Europese normen. Ook als het niet voorgeschreven is, zijn de Paulmann artikelen gecontroleerd door de VDE, TÜV of de kwaliteitsafdeling van Paulmann. Deze artikelen zijn in de catalogus gekentekend.

Onze producten van natuurlijke materialen en handgemaakt glas zijn uniek. Ze zijn in kleur en structuur onderhevig aan natuurlijke schommelingen.

Kleur

Materiaal

Beveiligingsklasse 2

Beveiligingsklasse 3

Koudlichtspiegel

Lagedruk

Product met maximale oppervlaktetemperatuur

De lamp is uitsluitend geschikt voor montage op niet ontvlambare materialen.

Beveiligingsklassen IP

Verklaringen zie pagina 445

Roestvrij

Instelbare kleuren

Knipperend

Freeze-functie







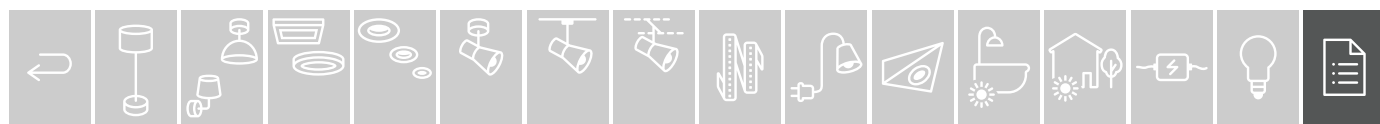























Flashlight-functie

Sound-sensor





























Met schakelaar





	Mit Kabel-Schalter inkl. Stecker	Avec commutateur de câble, y compris fiche mâle	Met kabelschakelaar incl. stekker
	Mit Touch-Dimmer	Avec variateur de contact (touch-dimmer)	Met touch-dimmer
	Mit Dimmer	Avec variateur	Met dimmer
	mit Stufen-Dimmer	Variateur à niveaux	trappen dimmer
	Bajonettverschluss	Fermeture à baïonnette	Bajonetsluiting
	Mit Steckertrafo	Avec transformateur à brancher	Met steckertrafo
	Stecker inklusive Schutzkontakt (Deutschland)	Fiche de prise de courant, contact de mise à la terre compris (Allemagne)	Stekker inclusief randaarding (Duitsland)
	Mit Steckverbinder	Avec connecteur enfichable	Met stekkerverbinding
	Mit Fernbedienung	Avec télécommande	Met afstandsbediening
	Bewegungsmelder mit Hochfrequenz-Sensor	Détecteur de mouvement avec capteur HF	Bewegungsmelder met sensor hoge frequentie
	Bewegungsmelder	Détecteur de mouvement	Bewegungsmelder
	Bewegungsmelder mit Näherungssensor	Détecteur de mouvement avec capteur de proximité	Bewegungsmelder met naderingssensor
	Batterie-, Akku-, Batterie und Akku-Betrieb möglich	Fonctionnement possible sur piles, sur accumulateurs, sur piles et accumulateurs	Gebruik met batterijen, met accu en met batterijen en accu mogelijk
	Batterie/Akku enthalten	Pile/accumulateur compris(e)	Inclusief batterij/accu
	Batterie/Akku austauschbar	Batterie/piles interchangeables	Batterij/accu vervangbaar
	Wand-, Boden- und/oder Deckenmontage	Montage mural/au sol et/ou au plafond	Wand-, vloer- en/of plafondmontage
	max. Belastung	Charge max.	max. belasting
	Seil-/Stangenabstand	Distance de câble/rail	Kabel-/stangenafstand
	Socket	Socle	Bodemplaat
K	Kelvin, Farbtemperatur Erläuterungen siehe Seite 441	Kelvin, température de couleur Explications voir page 441	Kelvin, kleurtemperatuur Verklaringen zie pagina 441
S	Scheinleistung	Puissance apparente	Schijnvermogen
	Einfache Montage	Montage simple	Eenvoudige montage
	Verwendung nur im Innenbereich	Utilisation intérieure uniquement	Gebruik alleen binnenshui
	Ringkerntrafo	Transformateur toroïda	Ringkerntrafo
	Integrierter Funkschutz	Protection radio intégrée	Ingebouwde radio ontstoring
	Integrierter Softstart	Démarrage soft intégré	Ingebouwde softstart
	Integrierter Kurzschluss-Schutz	Protection intégrée contre les courts-circuits	Ingebouwde kortsluitingsbeveiliging
	Erhöhter Spikeschutz	Protection Spike supérieure	Verhoogde spikebescherming
	Integrierter Brandschutz	Protection incendie intégrée	Ingebouwde brandbeveiliging
	Integrierter Überlastschutz	Protection intégrée contre les surcharges	Ingebouwde overbelastingsbeveiliging
	Integrierter wiedereinschaltbarer Temperaturwächter	Sonde thermique intégrée réenclenchable	Ingebouwde en schakelbare temperatuurbewaker
	Integrierter Temperaturwächter und elektronische Sicherung	Sonde thermique intégrée et fusible électronique	Ingebouwde temperatuurbewaker en elektronische zekering
	Integrierte elektronische Sicherung	Sonde thermique intégrée et fusible électronique	Ingebouwde elektronische zekering



	Integrierte Feinsicherung	Fusible électronique intégré	Ingebouwde fijnzekering
	SB-Verpackung	Emballage SB	Showverpakking voor haak
	Verpackungseinheit	Unité d'emballage	Verpakkingseenheid
	Energieeffizienzklasse	Classe d'efficacité énergétique	Energie-efficiëntieklasse
	flackerfreier Sofortstart	Allumage instantané sans clignotement	Directe inschakeling zonder flakkeren
	Lebensdauer	Durée de vie	Levensduur
	Lebensdauer elektronisches Vorschaltgerät	Durée de vie du ballast électronique	Levensduur elektronisch voorschakelapparaat
	Nicht für Allgemeinbeleuchtung, nur für Dekorationszwecke oder Spezialanwendungen	Ne convient pas à l'éclairage des pièces de vie, convient uniquement pour la décoration ou des applications spécifiques	Niet voor algemene verlichting, alleen voor decoratieve doeleinden of speciale toepassingen
	Textilkabel	Câble en textile	Textielkabel
	Dimmbar mit Smart Home App	Gradable avec Smart Home App	Dimbaar met Smart Home-app
	Bluetooth	Bluetooth	Bluetooth
	Zigbee	Zigbee	Zigbee
	Mit USB-Stecker	Avec fiche USB	Met USB-stekker
	Mit USB-Anschluß	Avec prise USB	Met USB-aansluiting
	Schutzkontaktsteckdose	Prise de terre	Gearde stekker
	variabel verstellbar	réglage variable	variabel verstelbaar
	einmalig kürzbar	pouvant être raccourci une fois	een keer inkortbaar
	Dimmbar mit PhasenANSchnittdimmer Erläuterungen siehe Seite 443	Variateur d'intensité de phase Explications voir page 443	Dimbaar met fase-Afsnijdingsdimmer Verklaringen zie pagina 443
	Dimmbar mit PhasenABSchnittdimmer Erläuterungen siehe Seite 443	Variateur d'intensité de section Explications voir page 443	Dimbaar met fase-Afsnijdingsdimmer Verklaringen zie pagina 443
	Dimmbar Erläuterungen siehe Seite 440	à intensité variable Explications voir page 440	dimbaar Verklaringen zie pagina 440
	3 step dim Erläuterungen siehe Seite 440	3 step dim Explications voir page 440	3 step dim Verklaringen zie pagina 440
	Easy dim Erläuterungen siehe Seite 440	Easy dim Explications voir page 440	Easy dim Verklaringen zie pagina 440
	3 Step dim to warm Erläuterungen siehe Seite 440	3 Step dim to warm Explications voir page 440	3 Step dim to warm Verklaringen zie pagina 440
	Dim to warm Erläuterungen siehe Seite 440	Dim to warm Explications voir page 440	Dim to warm Verklaringen zie pagina 440
	White Switch Erläuterungen siehe Seite 441	White Switch Explications voir page 441	White Switch Verklaringen zie pagina 441
	Tunable white Erläuterungen siehe Seite 441	Tunable white Explications voir page 441	Tunable white Verklaringen zie pagina 441
	RGBW Erläuterungen siehe Seite 441	RGBW Explications voir page 441	RGBW Verklaringen zie pagina 441
	RGB Rainbow Erläuterungen siehe Seite 441	RGB Rainbow Explications voir page 441	RGB Rainbow Verklaringen zie pagina 441

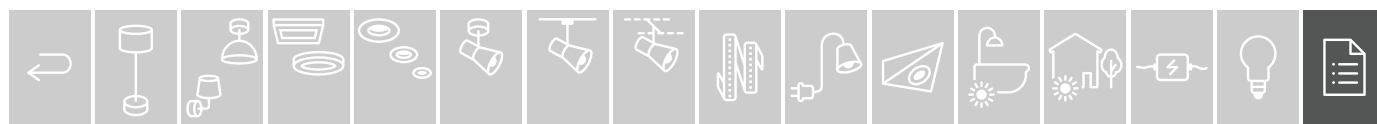





**Paulmann**

[www.paulmann.com](http://www.paulmann.com)

Paulmann Licht GmbH | Quezinger Feld 2 | 31832 Springe/Germany